

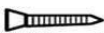
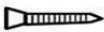
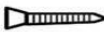
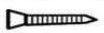
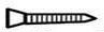

A  3.5*45 8pcs

B  3.5*30 8pcs

C  3.0*30 1pcs

D  3.0*16 12pcs

E  3.0*12 2pcs

 (1pc)

L  (1pc)  4 pcs

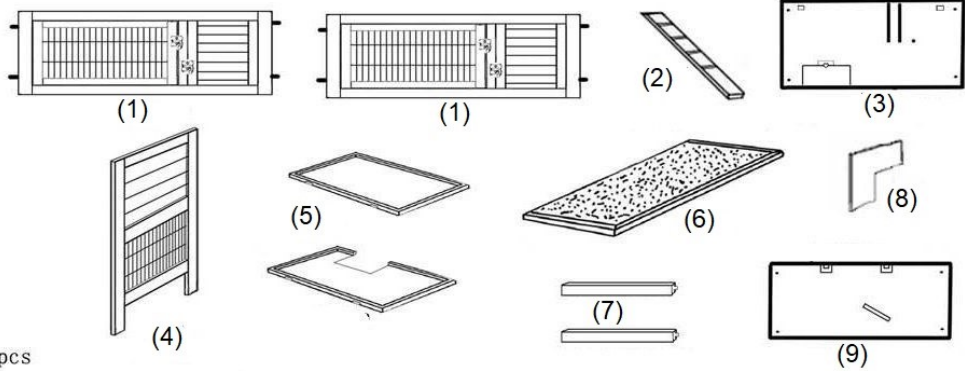

Nr.	Betekening	Nr.	Betekening
1	Frontelement	6	Dak
2	Opgang (1x)	7	Houten stokken
3	Bovenst achterwand	8	Tussenwand
4	Zijwand (2x)	9	Onderste achterwand
5	Bodem		

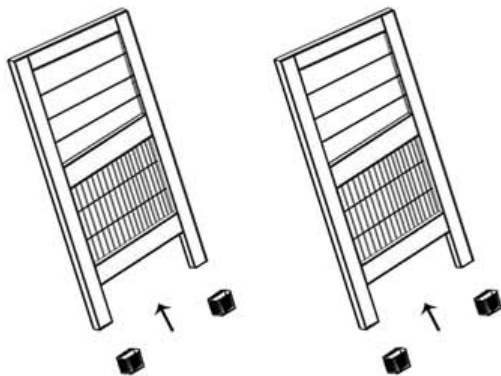

Stap 1

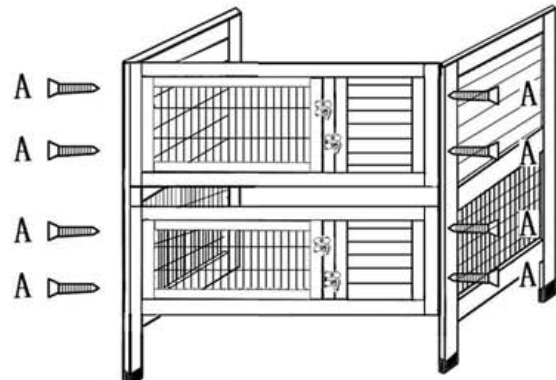

Stap 2

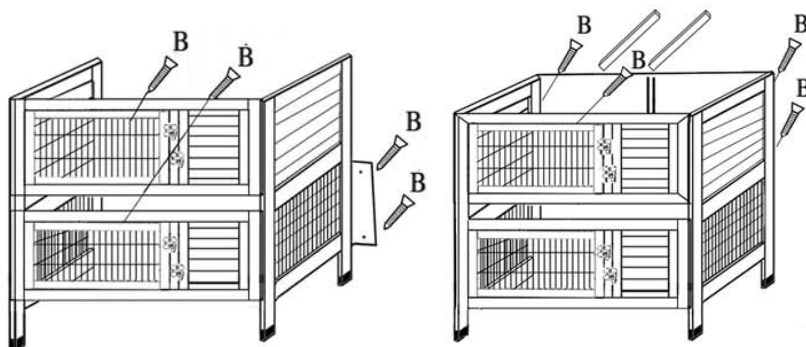

Stap 3

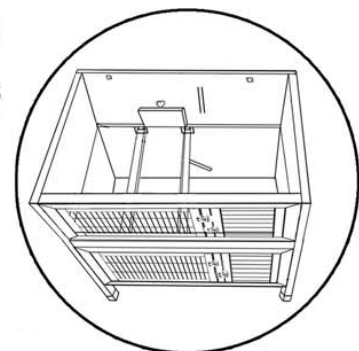

Stap 4

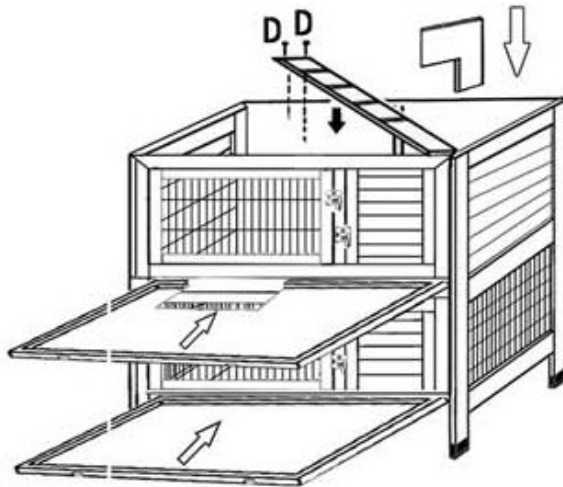

Stap 5

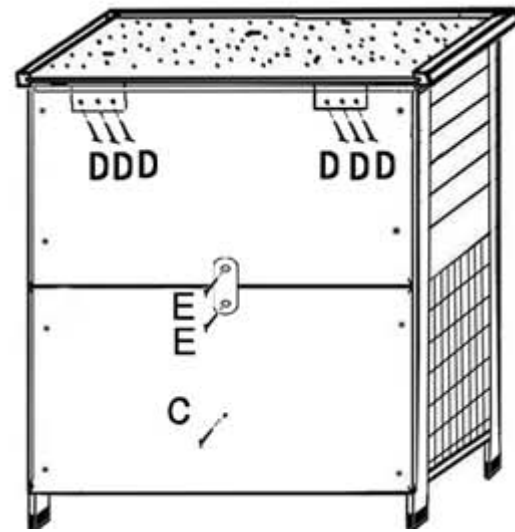

De onderkant van de oprit vastzetten door de achterwand met schroef **C**.

Stap 6

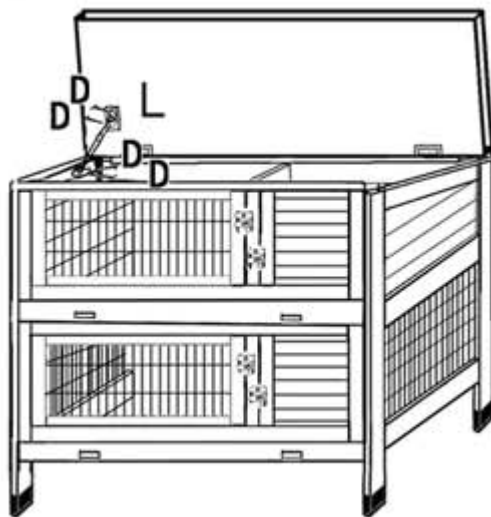

Stap 7

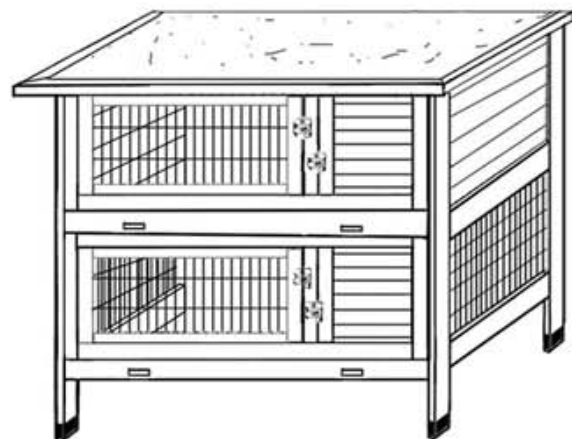

Stap 8

Belangrijk:

Het op welke manier kopiëren van deze handleiding en/of gebruik ervan voor commerciële doeleinden, is alleen toegestaan met schriftelijke toestemming van WilTec Wildanger Technik GmbH vooraf.