













<p>A</p>  <p>M6x55 mm (8)</p>	<p>B</p>  <p>3,5x25 mm (10)</p>	<p>C</p>  <p>3,5x30 mm (12)</p>	
<p>D</p>  <p>3,0x20 mm (12)</p>	<p>E</p>  <p>3,0x12 mm (2)</p>	<p>F</p>  <p>(1)</p>	
 <p>Ax1</p>	 <p>Bx1</p>	 <p>Cx1</p>	 <p>Dx1</p>
 <p>Ex1</p>	 <p>Fx1</p>	 <p>G1x1</p>	 <p>G2x1</p>
 <p>H1x1</p>	 <p>H2x1</p>	 <p>H3x1</p>	 <p>H4x1</p>
 <p>I1x1</p>		 <p>I2x1</p>	

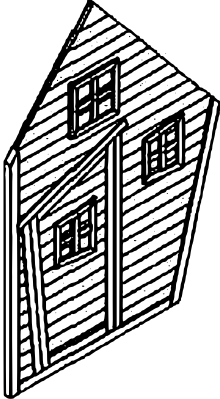
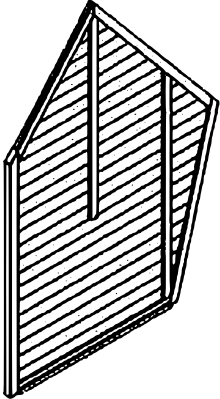
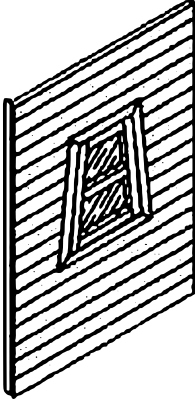
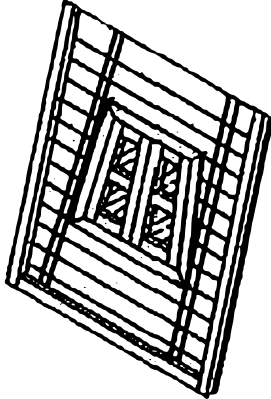
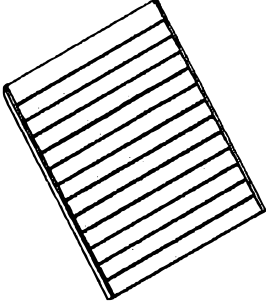
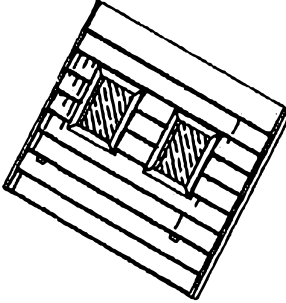
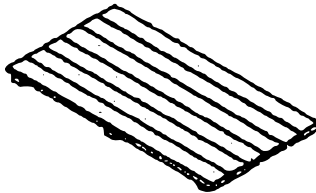
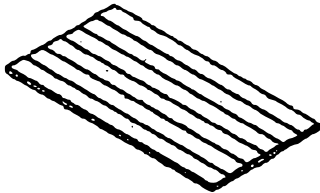

Avis important :

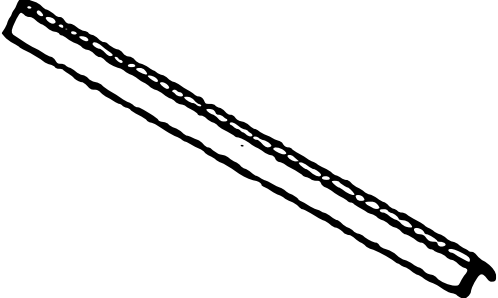
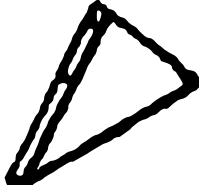
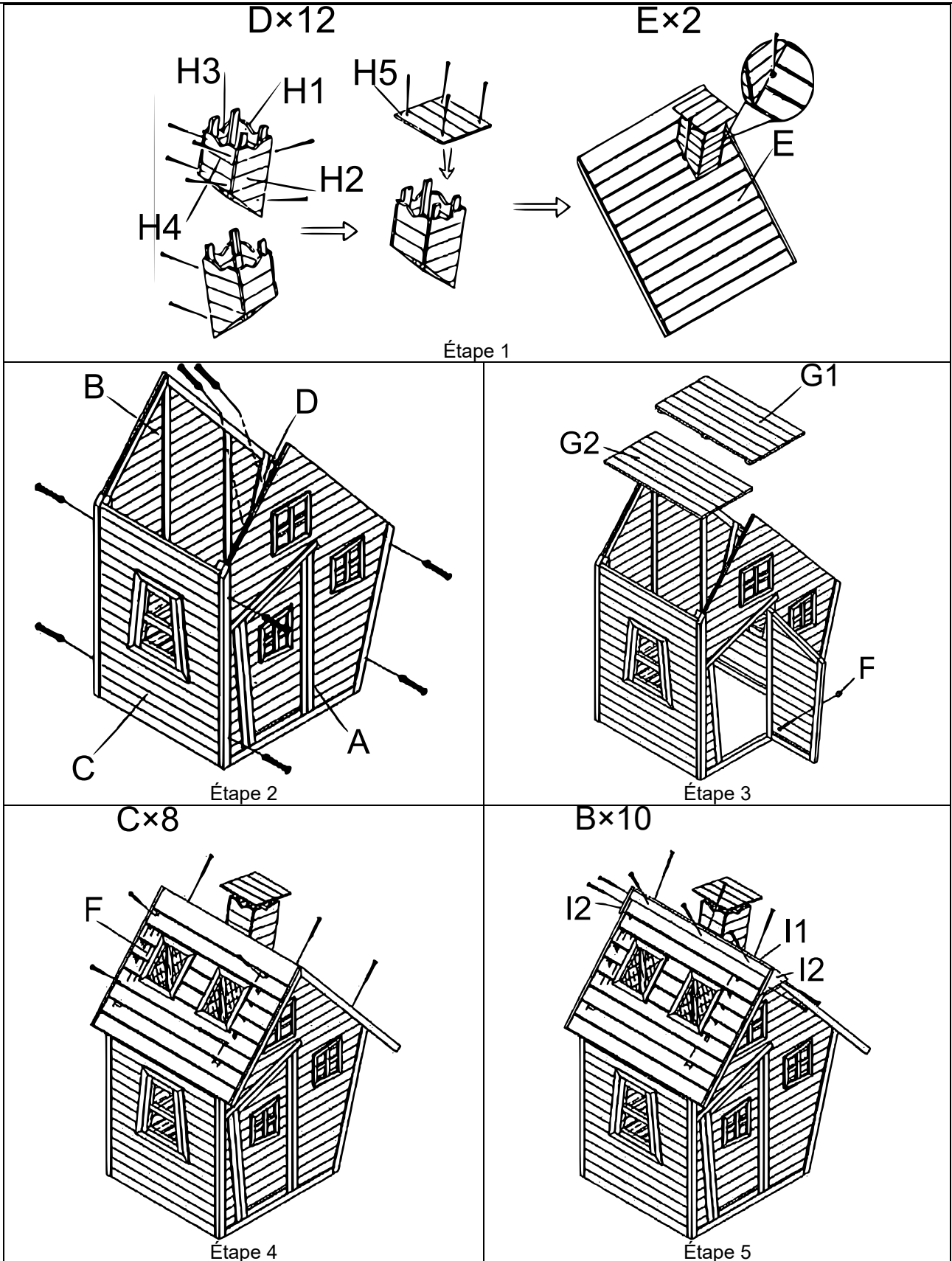
Toute reproduction et toute utilisation à des fins commerciales, même partielle de ce mode d'emploi, ne sont autorisées qu'avec l'accord préalable de la société WilTec Wildanger Technik GmbH.