







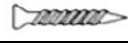
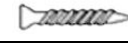

No	Figure	Qty.	No	Figure	Qty.	No	Figure	Qty.
1		1	2		1	15		1
3		1	4		1	16		1
5		1	6		1	17		1
7		1	8		1	18		2
9		1	10		1	19		1
11		2	12		1	20		1
13					1	21		1
14					1	22		2

A	 3.5×40 (24+1)	B	 3.5×50 (8+1)	C	 3.0×16 (6+1)	D	 3.5×35 (8+1)	E	 3.0×25 (1+1)	
F	 3.0×38 (6+1)	G								

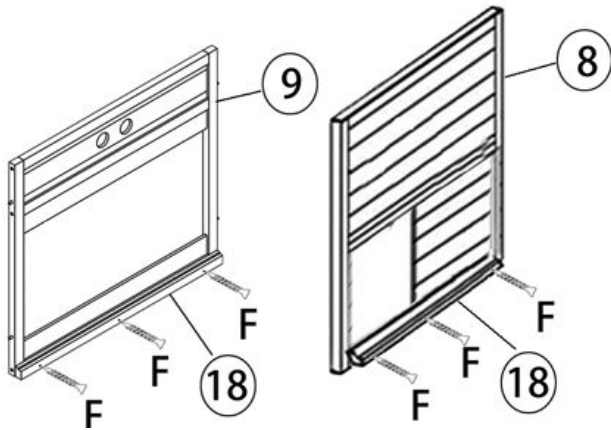

Step 1

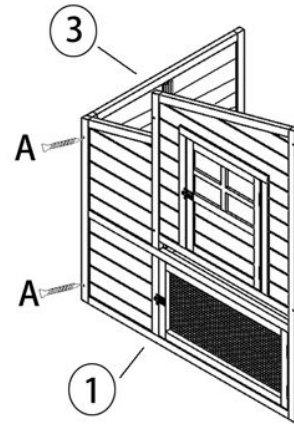

Step 2

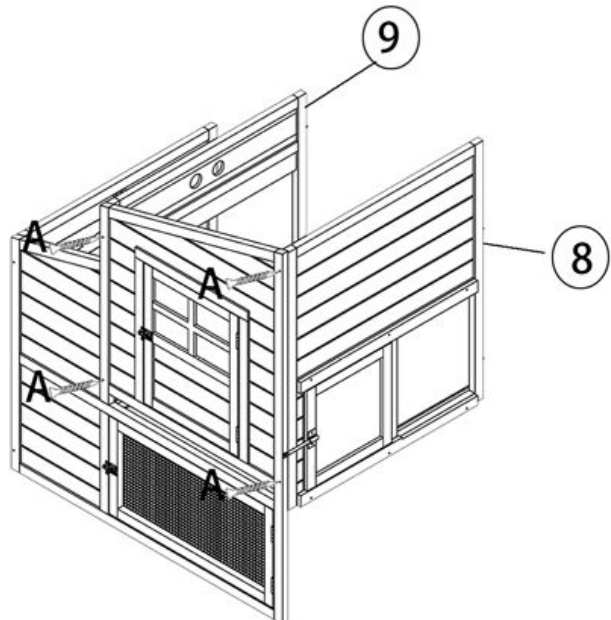

Step 3

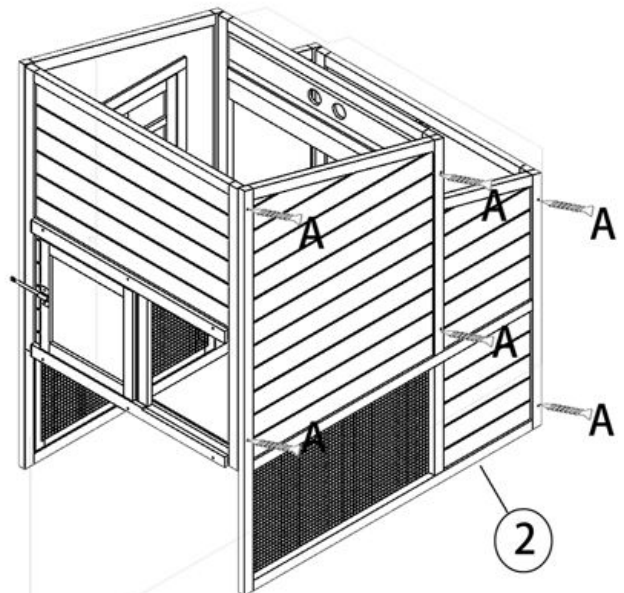

Step 4

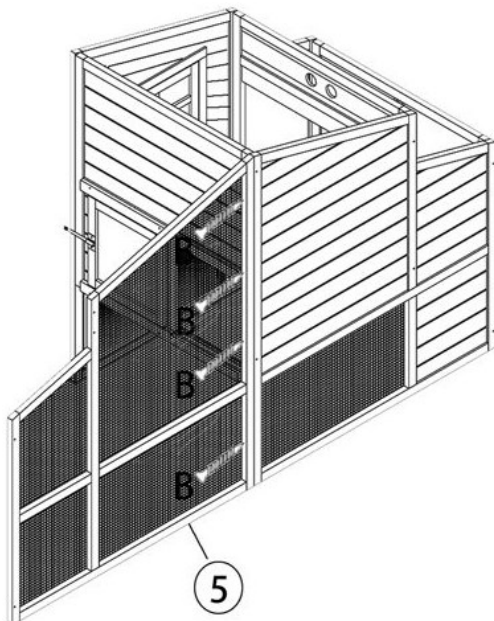

Step 5

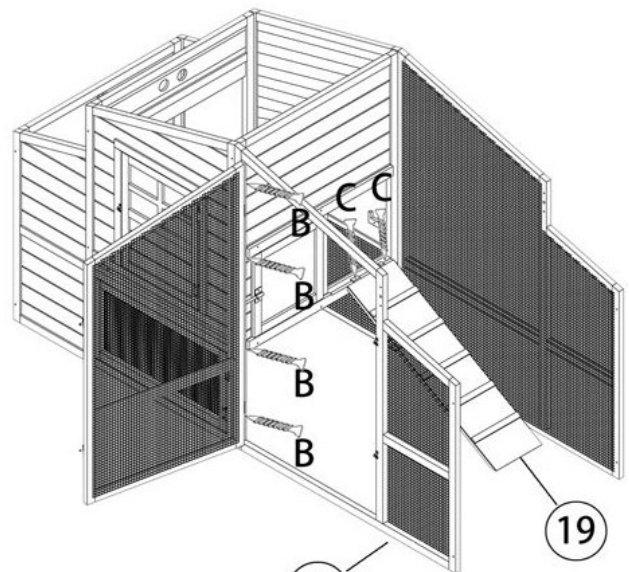

Step 6

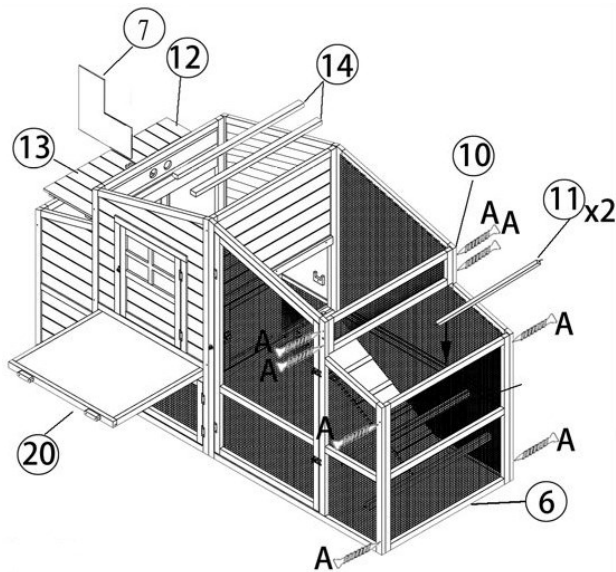

Step 7

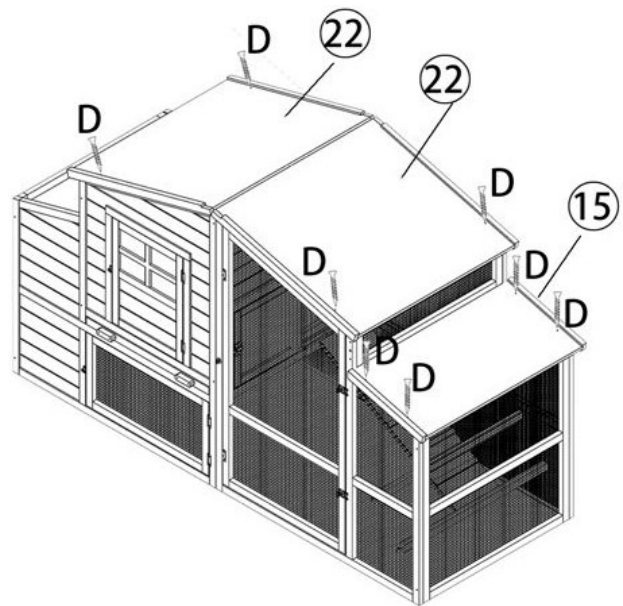

Step 8

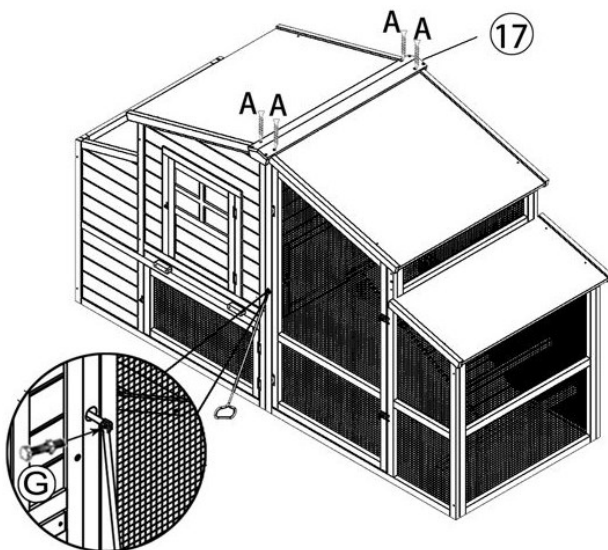

Step 9

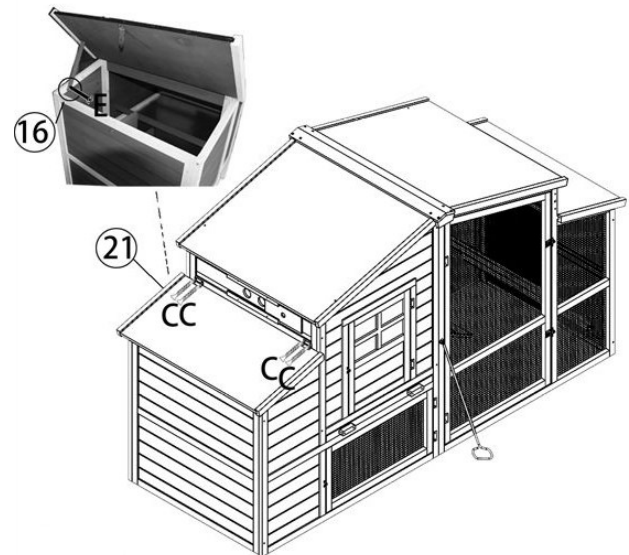

Step 10

Important notice:

The reprint or reproduction, even of excerpts, and any commercial use, even in part, of this instruction manual require the written permission of WilTec Wildanger Technik GmbH.