







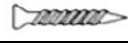
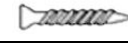

Nº	Figure	Qté	Nº	Figure	Qté	Nº	Figure	Qté
1		1	2		1	15		1
3		1	4		1	16		1
5		1	6		1	17		1
7		1	8		1	18		2
9		1	10		1	19		1
11		2	12		1	20		1
13					1	21		1
14					1	22		2

<b>A</b>	 3,5×40 (24+1)	<b>B</b>	 3,5×50 (8+1)	<b>C</b>	 3,0×16 (6+1)	<b>D</b>	 3,5×35 (8+1)	<b>E</b>	 3,0×25 (1+1)	
<b>F</b>	 3,0×38 (6+1)	<b>G</b>								

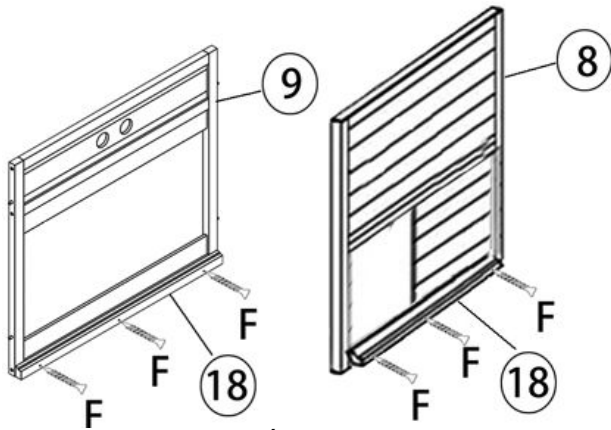

Étape 1

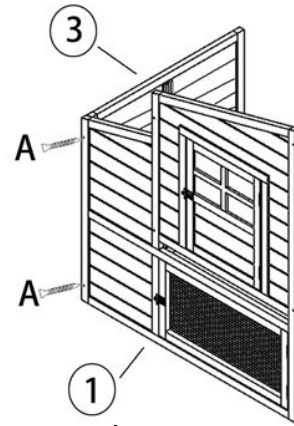

Étape 2

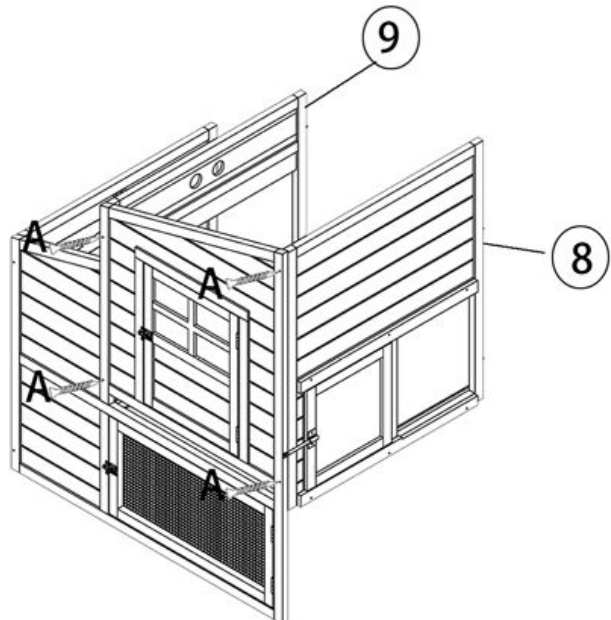

Étape 3

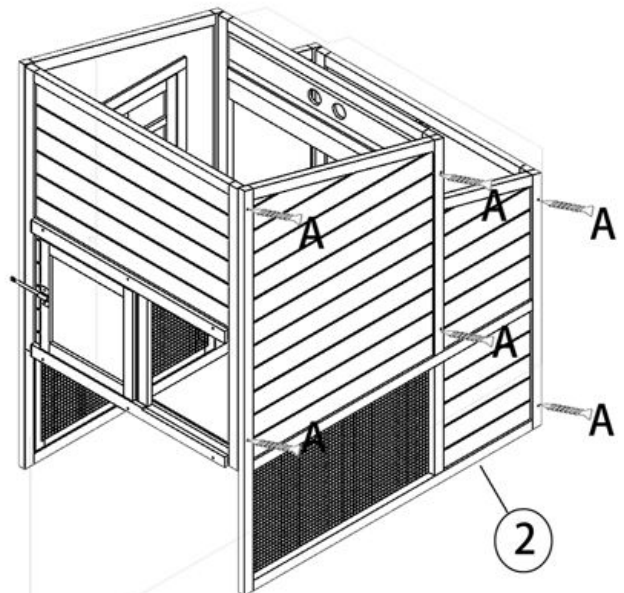

Étape 4

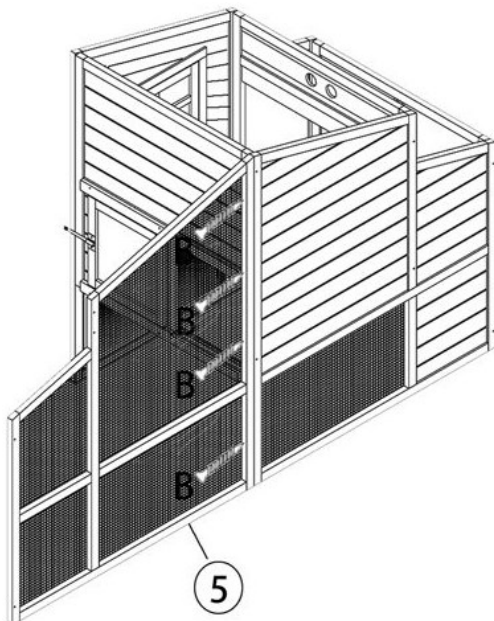

Étape 5

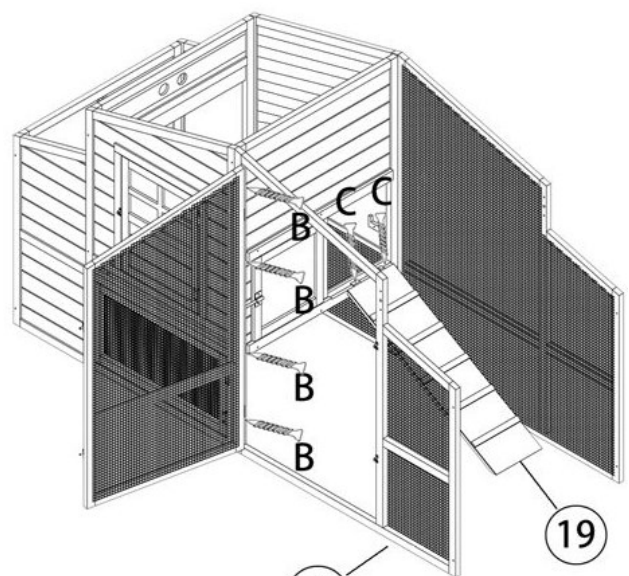

Étape 6

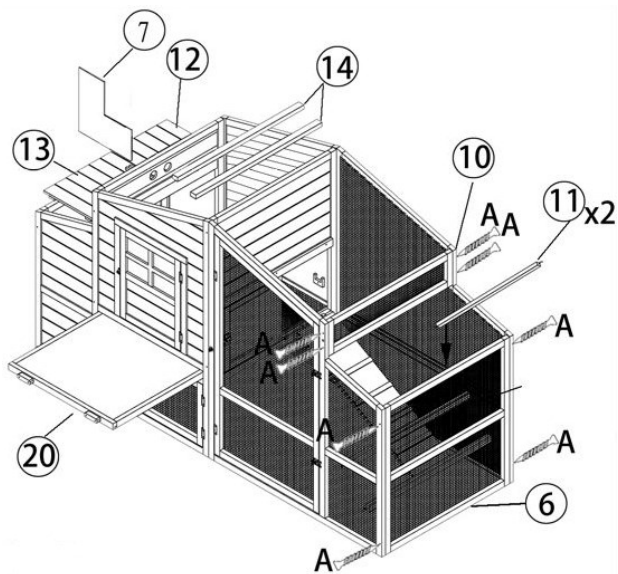

Étape 7

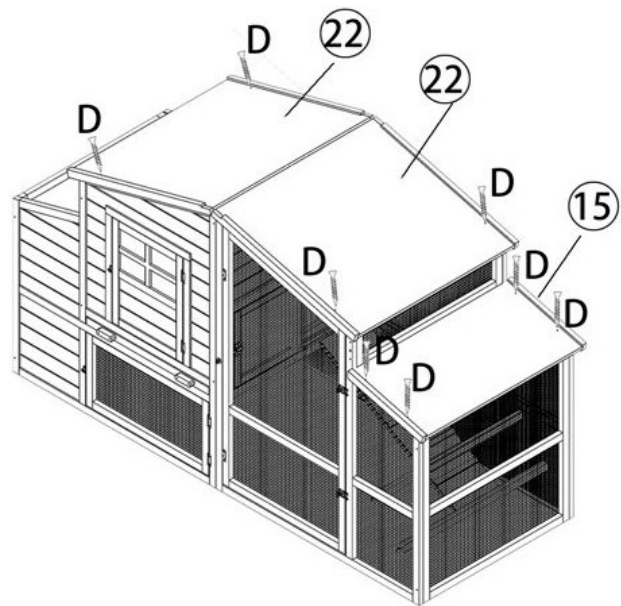

Étape 8

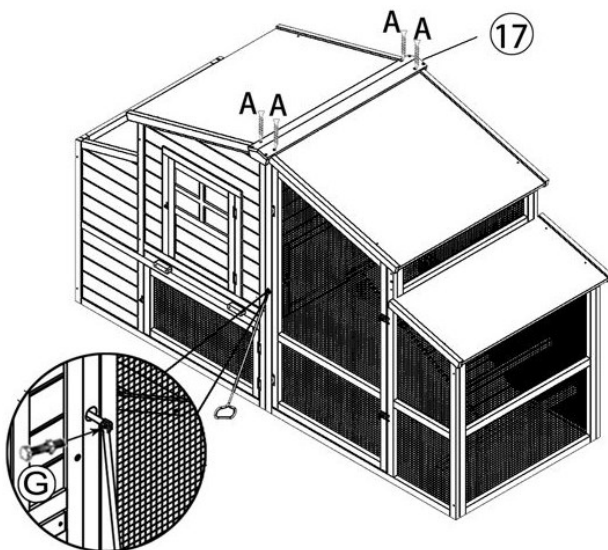

Étape 9

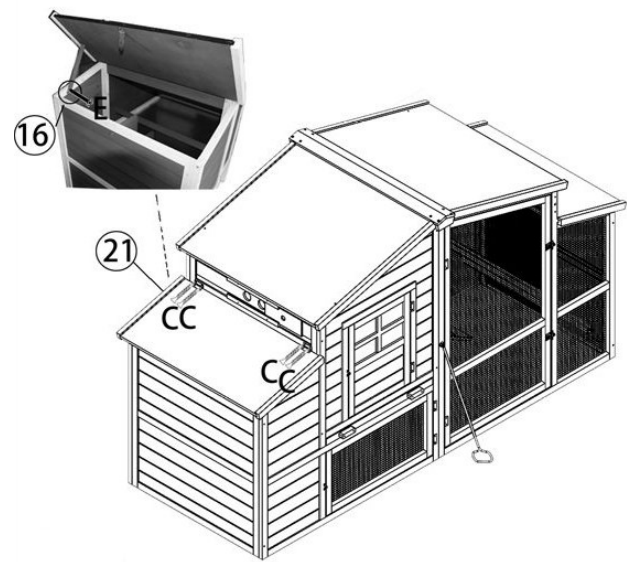

Étape 10

Avis important :

Toute reproduction et toute utilisation à des fins commerciales, même partielle de ce mode d'emploi, ne sont autorisées qu'avec l'accord préalable de la société WilTec Wildanger Technik GmbH.