

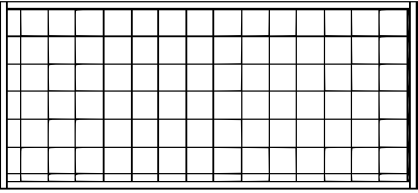







Nr.	Avbildning	Bokst.	Avbildning
1	 100×43×2	A	 4×15×8
2	 96×43×2	B	 4×40×12
3	 100×50×2	C	 2×

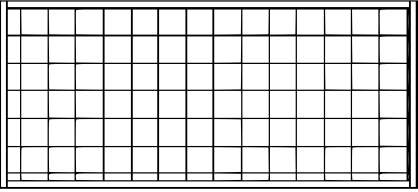

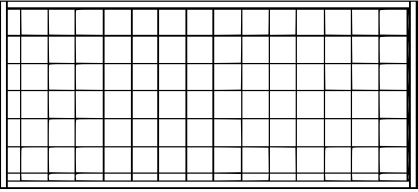
Viktig anmärkning:

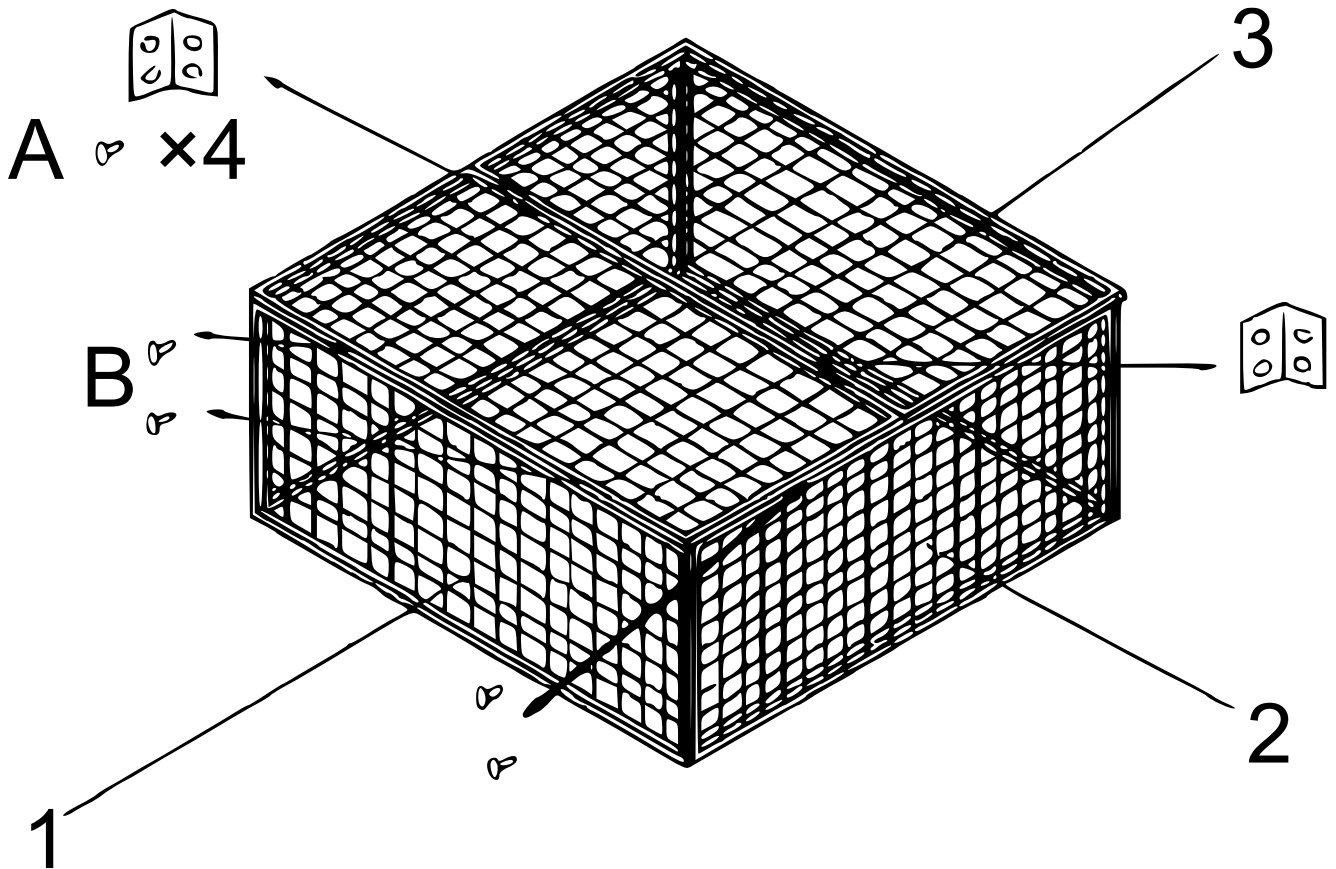
Varje sätt av delvis eller fullständigt mångfaldigande eller kommersiellt nyttjande av denna bruksanvisning behöver ett skriftligt godkännande från WilTec Wildanger Technik GmbH.