

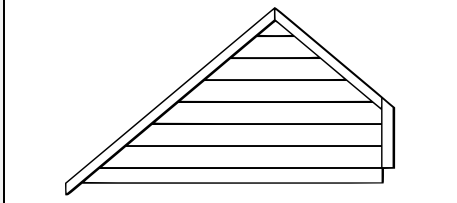

Nº	Figura	Uds.	Nº	Figura	Uds.
1		1	10		2
2		1	11		1
			12		1
3		1	13		1
4		1	14		1
			15		1
5		1	16		1
			17		1

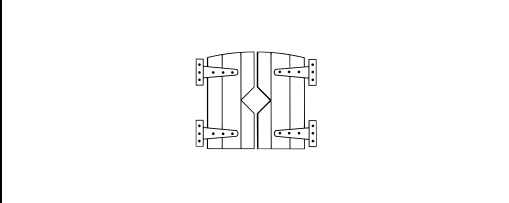
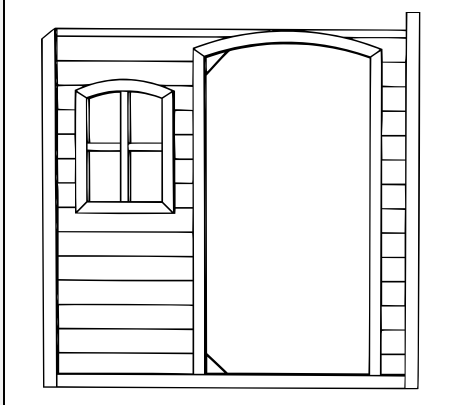
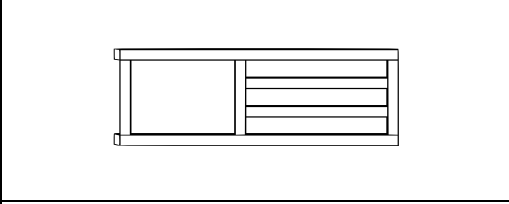
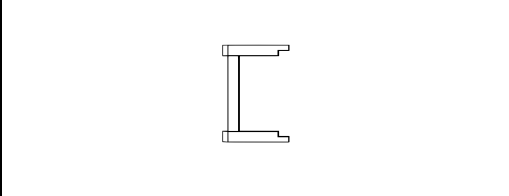
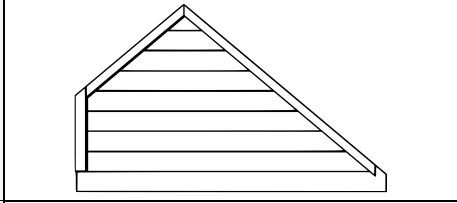
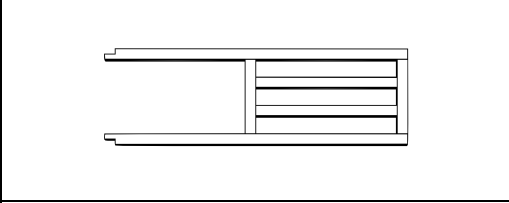
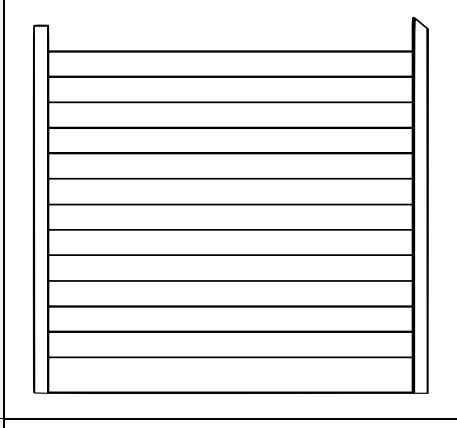
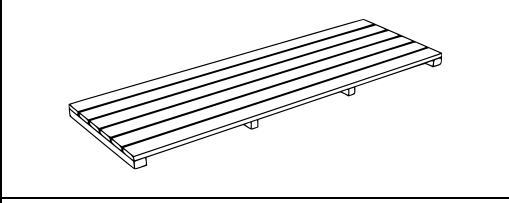
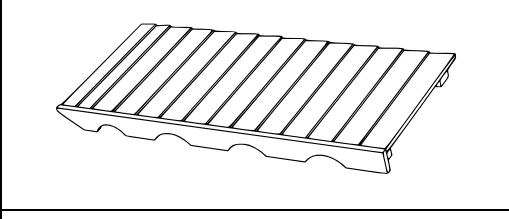
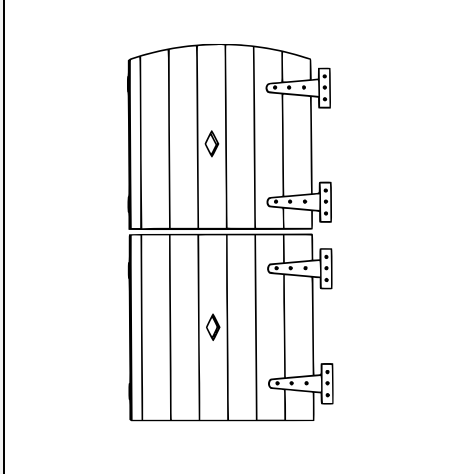
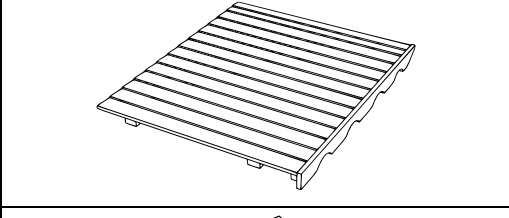
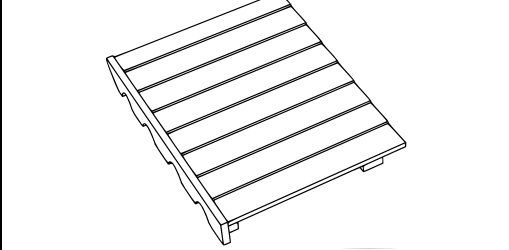

6		1		1	18		1
7		1			19		1
8		1			20		1
					21		2
					22		2
					23		2
					24		2
					9		1

A	B	C	D	E	F	G	H	I
4	26	14	16	39	36	8	8	4



**Paso 1 | F×12**  
Al montar la puerta y la ventana, deje un espacio de 13 mm para evitar pellizcos posteriores.

**Paso 2 | E×14**

**Paso 3 | E×13**

**Paso 4 | F×12**

**Paso 5 | F×12**

**Paso 6 | C×8**

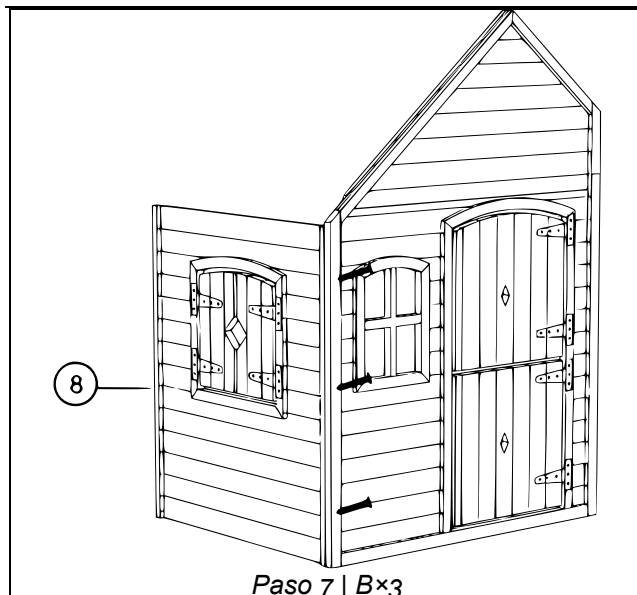

Paso 7 | B×3

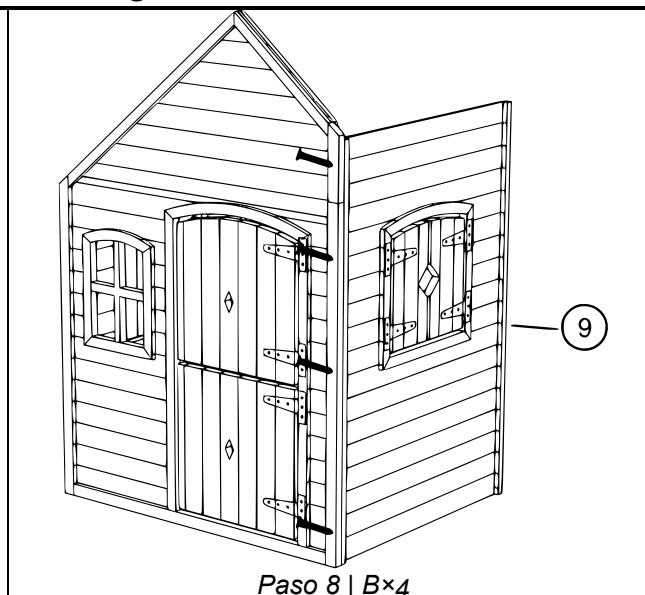

Paso 8 | B×4

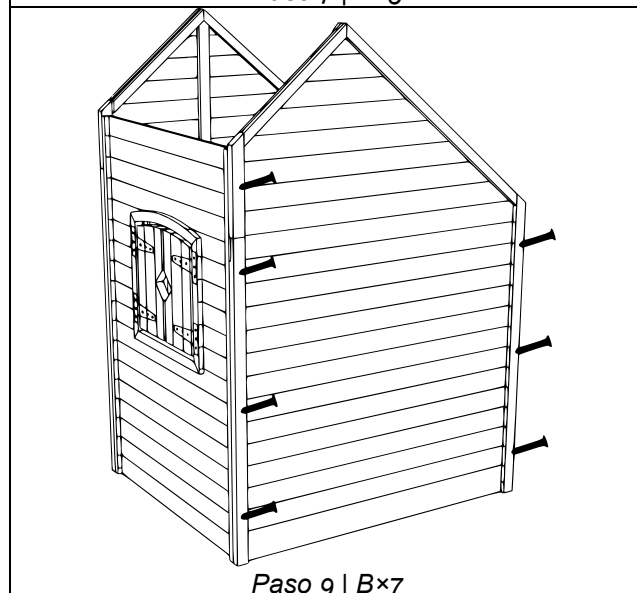

Paso 9 | B×7

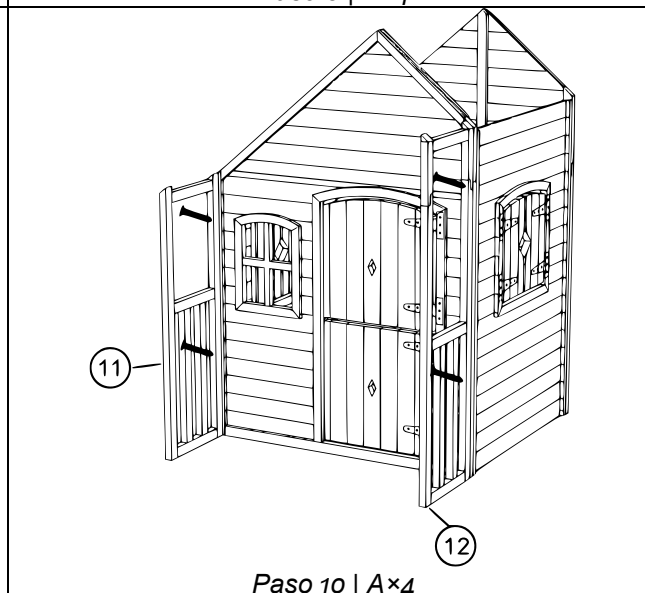

Paso 10 | A×4

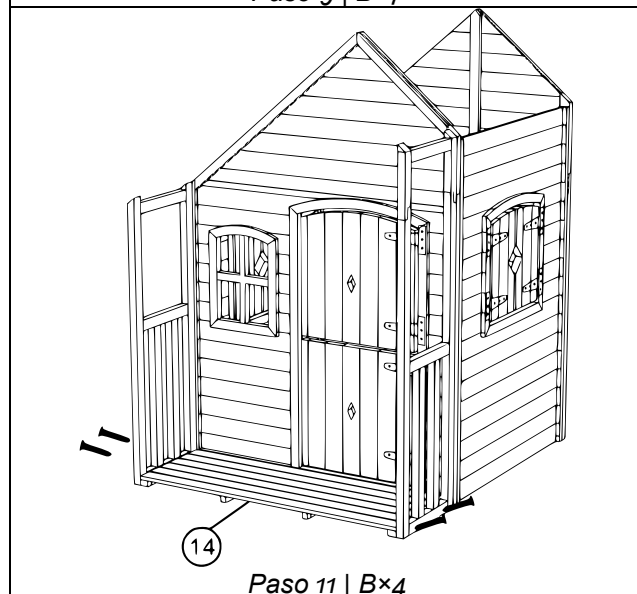

Paso 11 | B×4

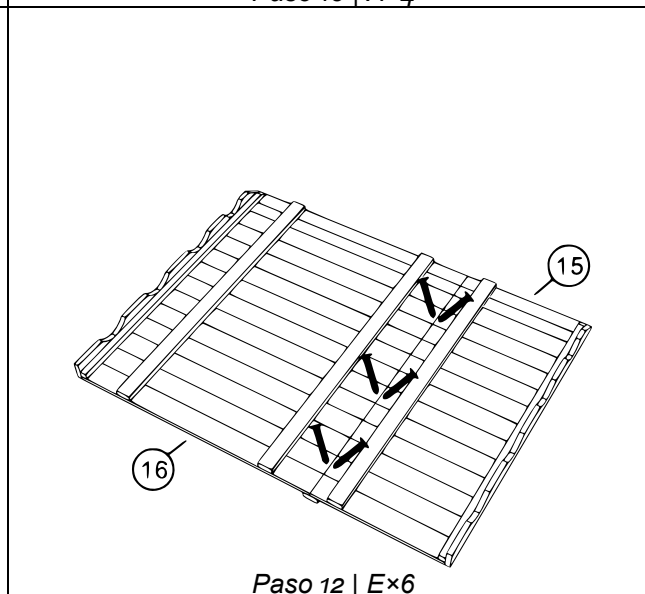

Paso 12 | E×6

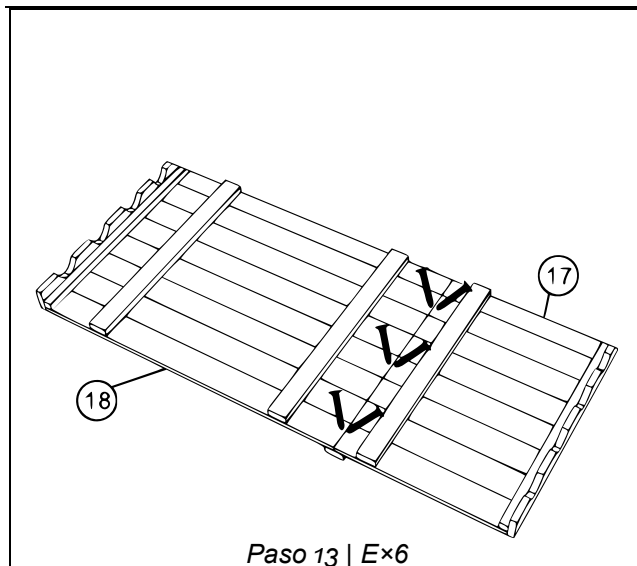

Paso 13 | E×6

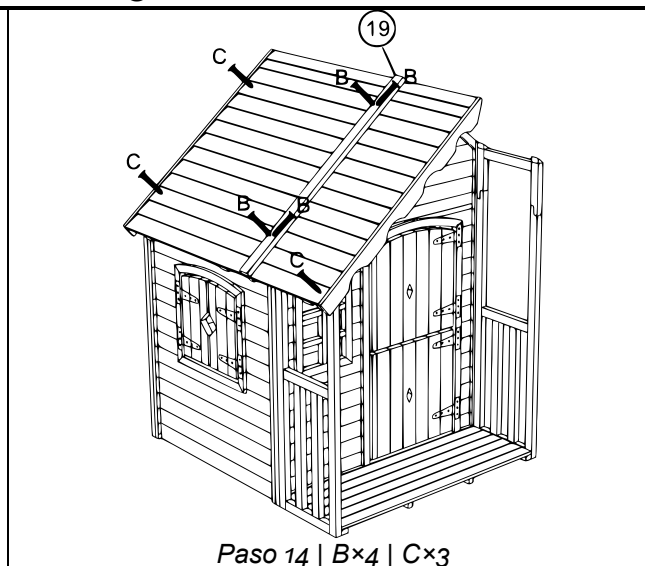

Paso 14 | B×4 | C×3

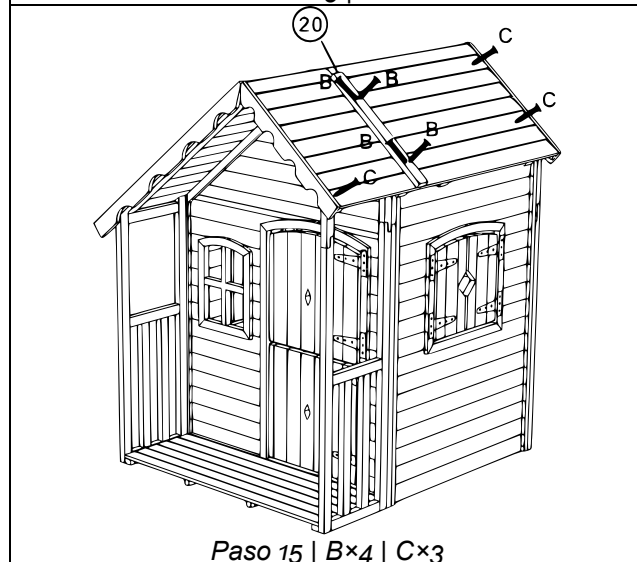

Paso 15 | B×4 | C×3

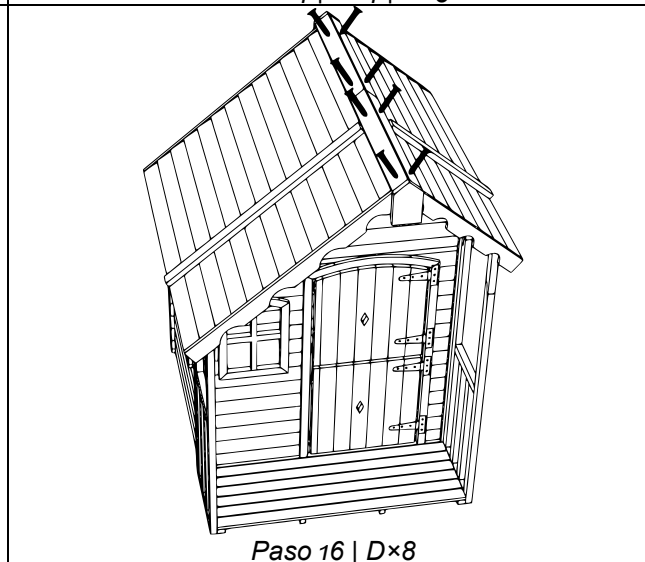

Paso 16 | D×8

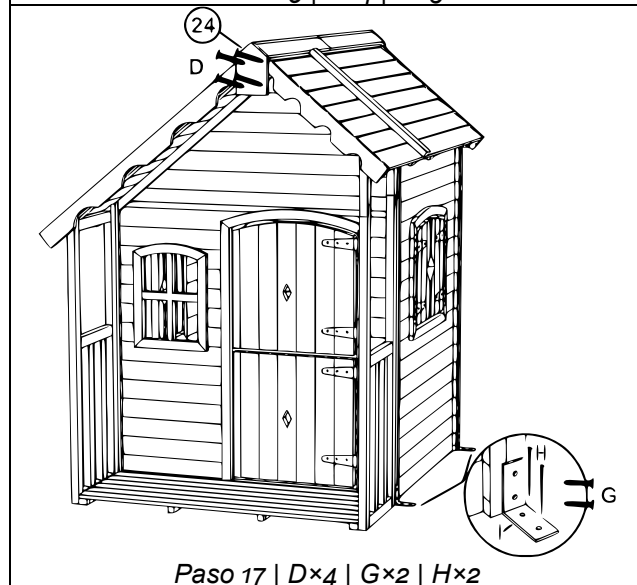

Paso 17 | D×4 | G×2 | H×2

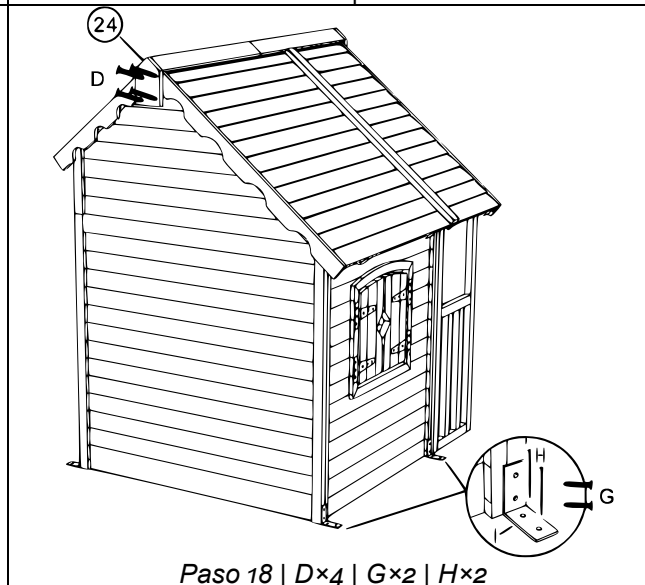

Paso 18 | D×4 | G×2 | H×2

Aviso importante:

La reimpression de este manual, también parcial, así como cualquier uso comercial, incluso de algunas de sus partes, solo con autorización por escrito de la empresa WilTec Wildanger Technik GmbH.