

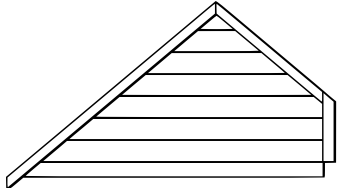

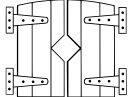

N°	Figura	Qtà.	N°	Figura	Qtà.
1		1	10		2
2		1	11		1
			12		1
3		1	13		1
4		1	14		1
			15		1
5		1	16		1
			17		1

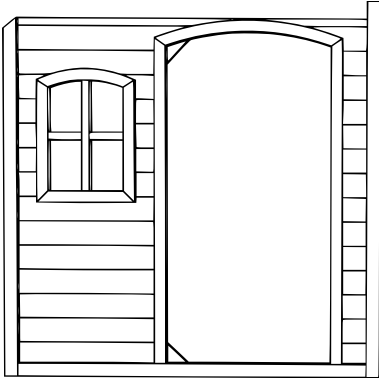
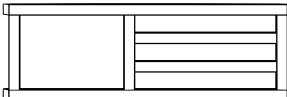

6		1		18		1
7		1		19		1
8		1		20		1
				21		2
				22		2
				23		2
				24		2
				9		1

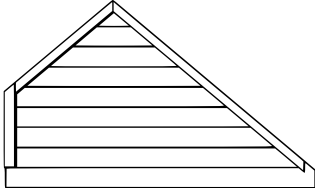
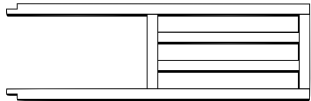
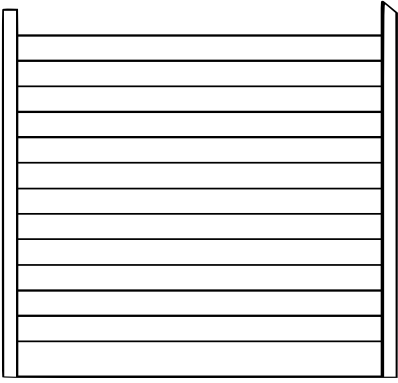
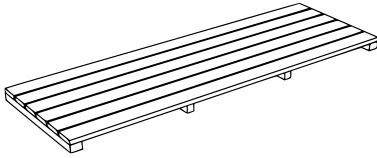
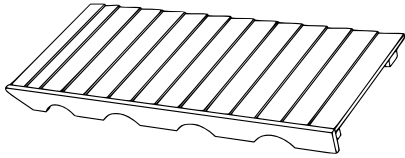
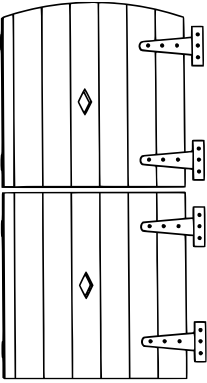
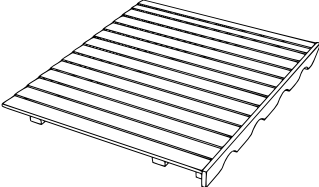
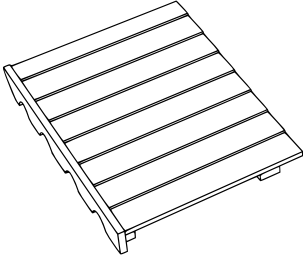
A	B	C	D	E	F	G	H	I
3,5×60	3,5×50	3,0×30	3,0×25	3,0×20	3,0×16	3,5×24		
4	26	14	16	39	36	8	8	4

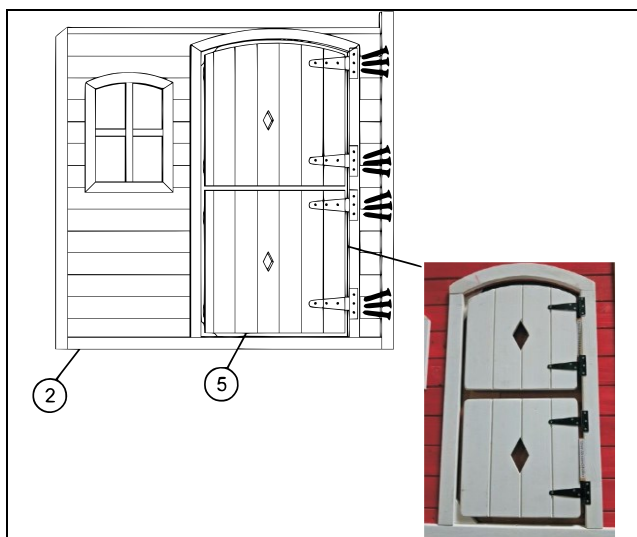

Passaggio 1 | F×12

Quando si assemblano la porta e la finestra, lasciare uno spazio di 13 mm per evitare di schiacciarsi le dita in seguito.

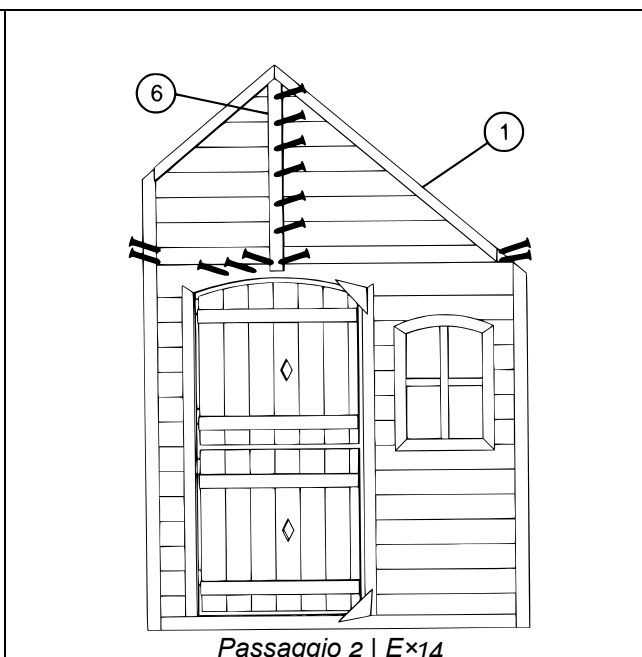

Passaggio 2 | E×14

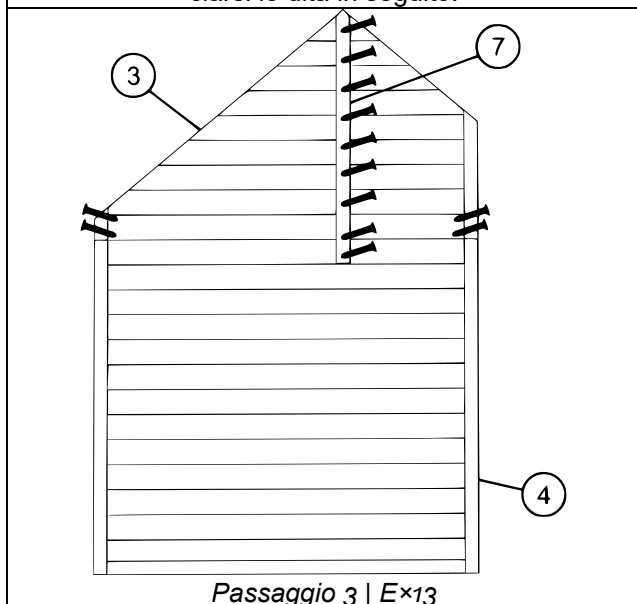

Passaggio 3 | E×13

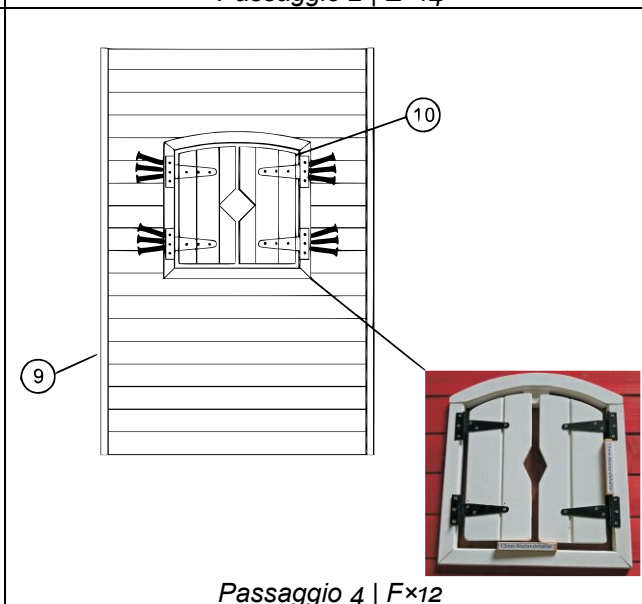

Passaggio 4 | F×12

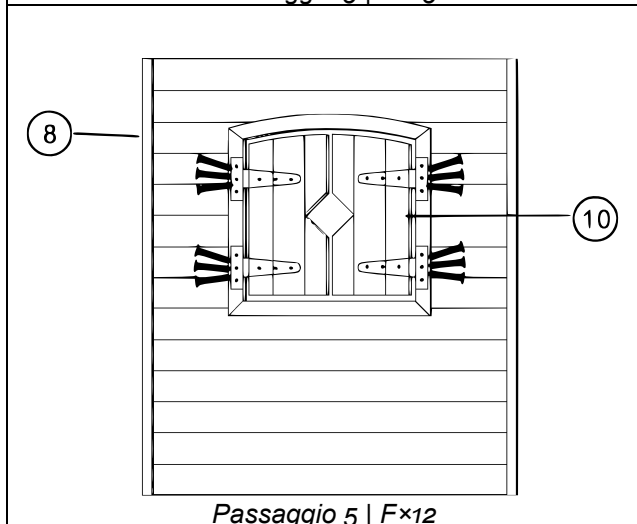

Passaggio 5 | F×12

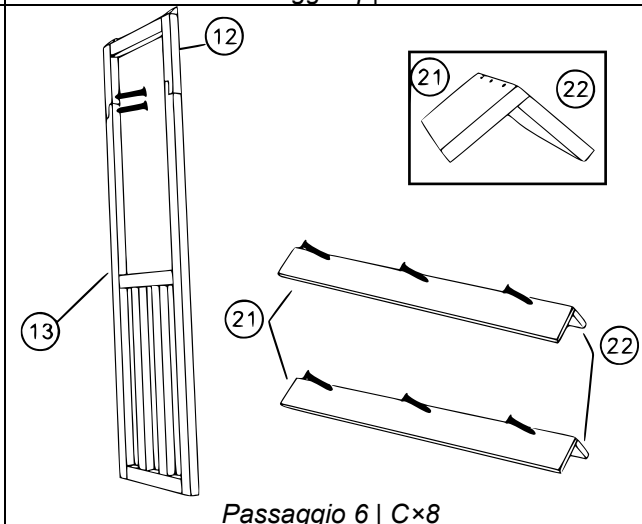

Passaggio 6 | C×8

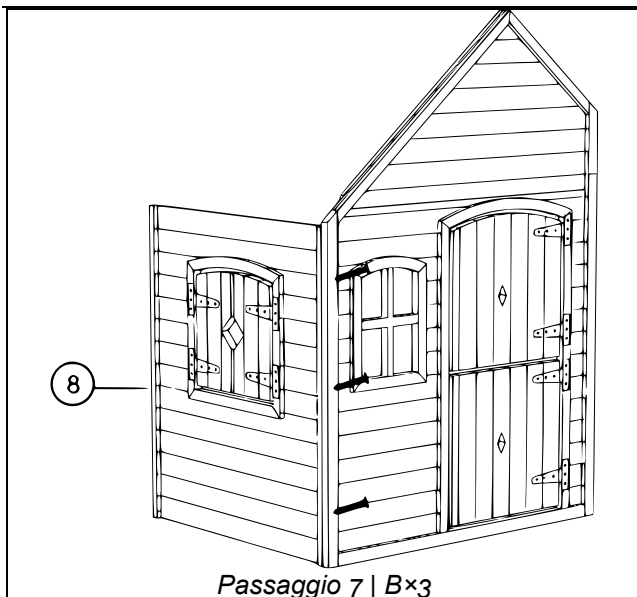

Passaggio 7 | B×3

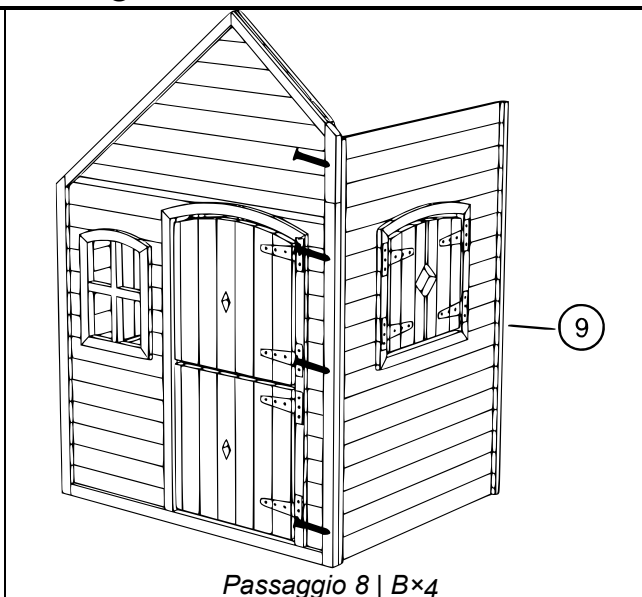

Passaggio 8 | B×4

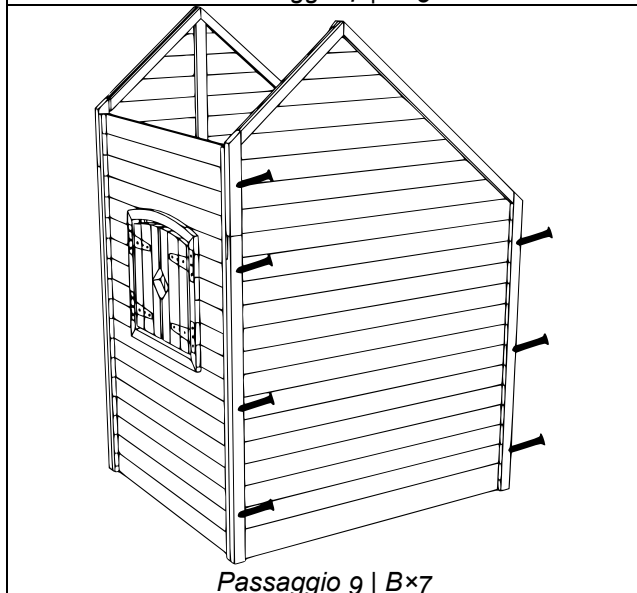

Passaggio 9 | B×7

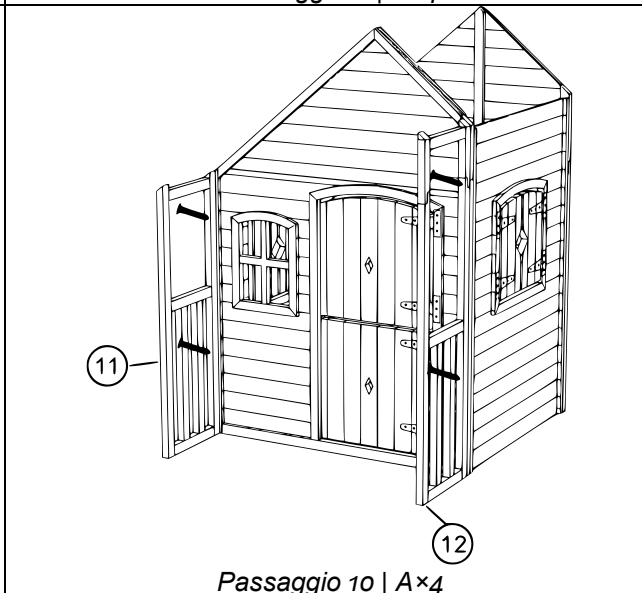

Passaggio 10 | A×4

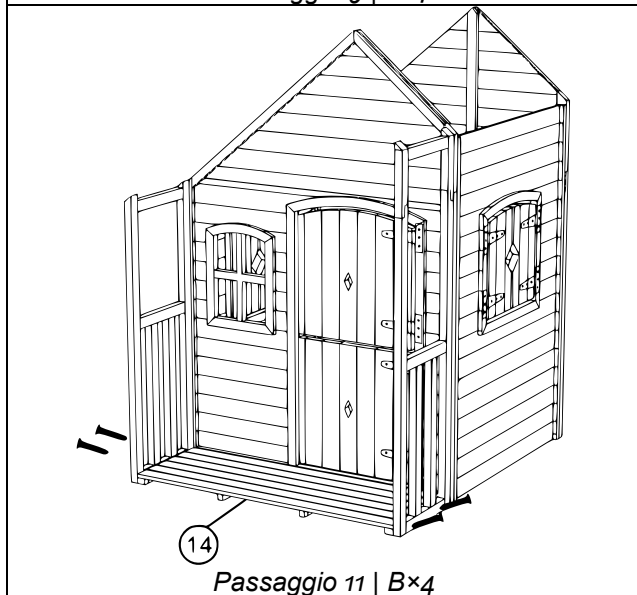

Passaggio 11 | B×4

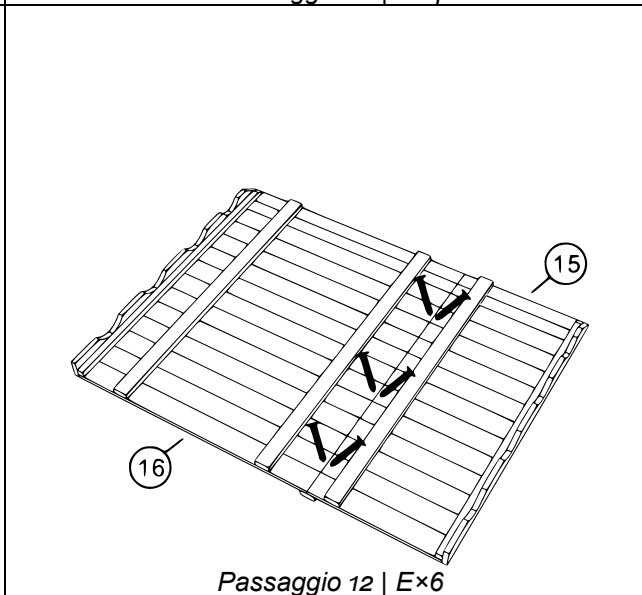

Passaggio 12 | E×6

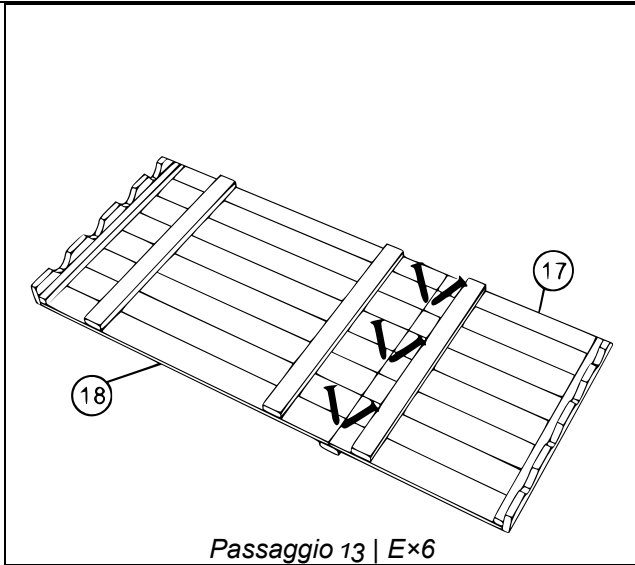

Passaggio 13 | E×6

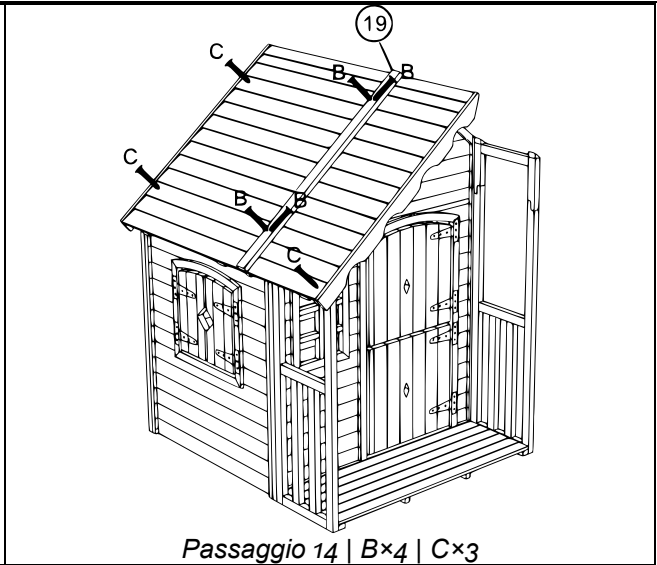

Passaggio 14 | B×4 | C×3

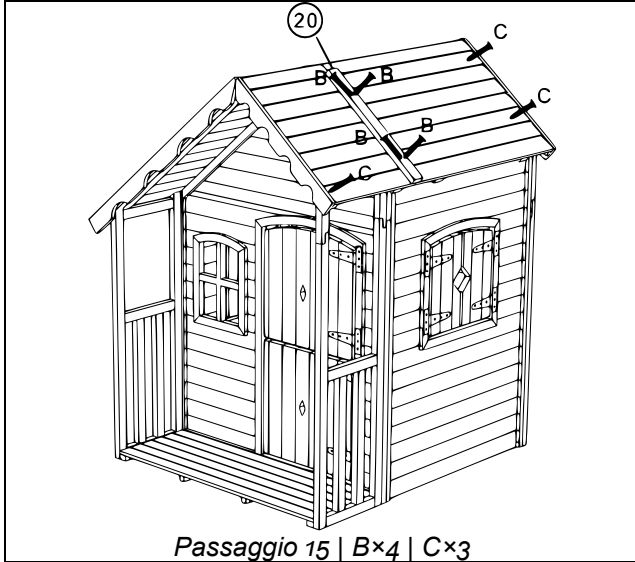

Passaggio 15 | B×4 | C×3

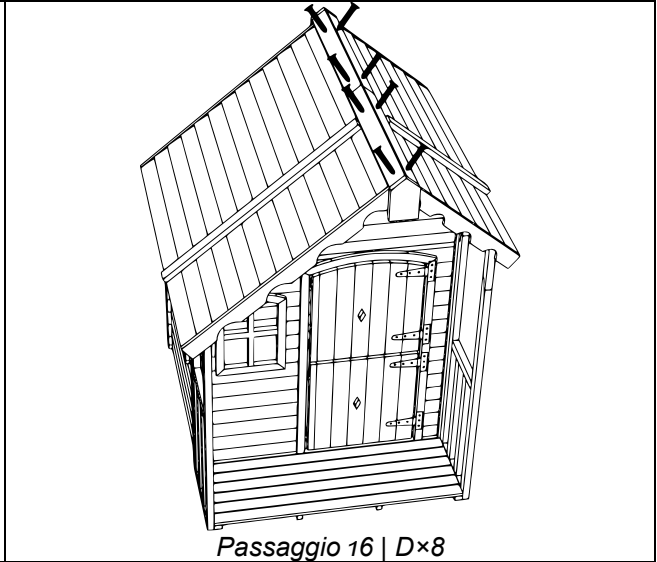

Passaggio 16 | D×8

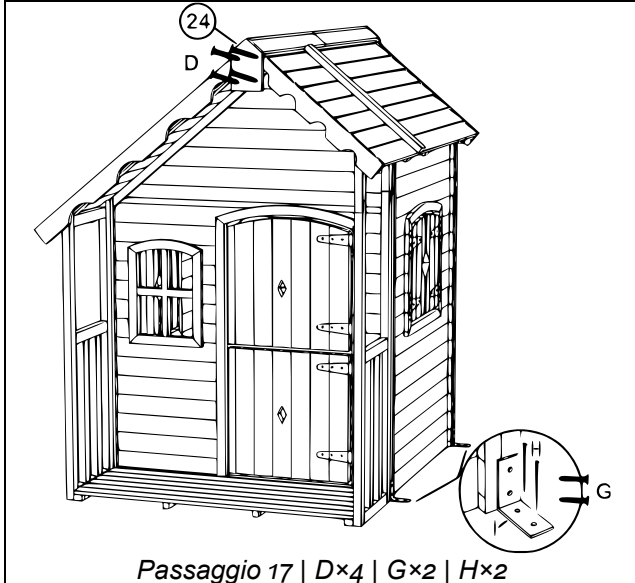

Passaggio 17 | D×4 | G×2 | H×2

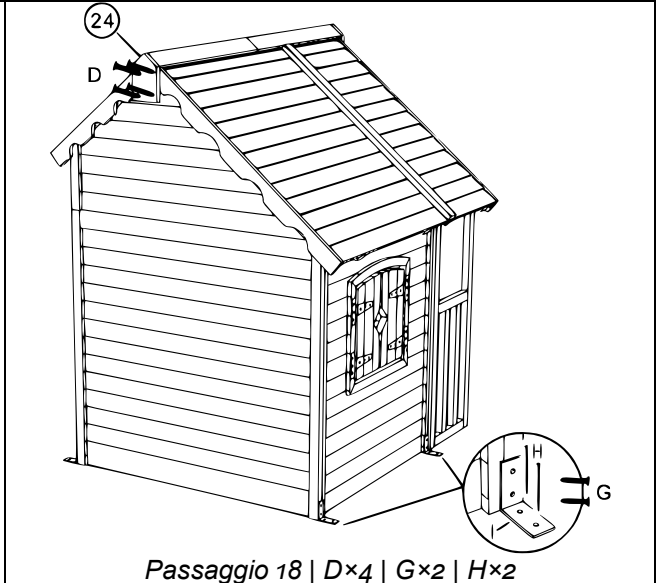

Passaggio 18 | D×4 | G×2 | H×2

Avviso importante:

La riproduzione e qualsiasi uso commerciale del manuale, anche se solo parziale, è esclusivamente ammessa con previa autorizzazione scritta da parte di WilTec Wildanger Technik GmbH.