

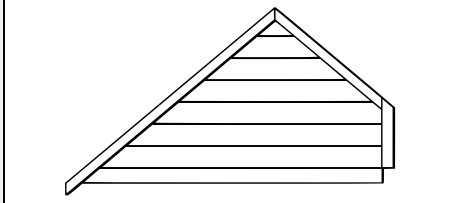

Nr.	Afbeelding	Aant.	Nr.	Afbeelding	Aant.
1		1	10		2
2		1	11		1
			12		1
3		1	13		1
4		1	14		1
			15		1
5		1	16		1
			17		1

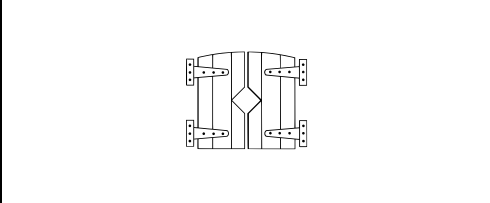
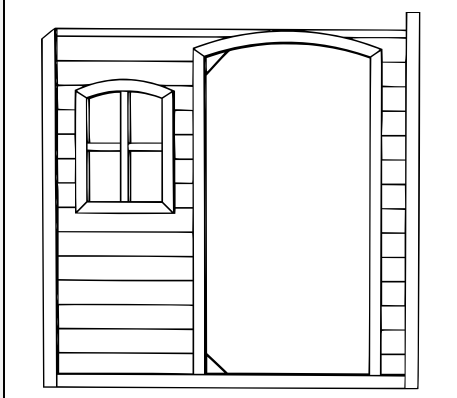
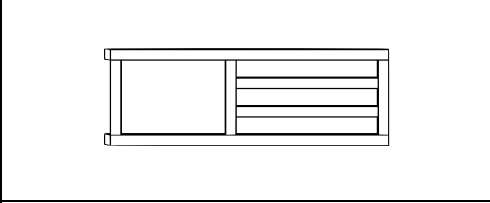
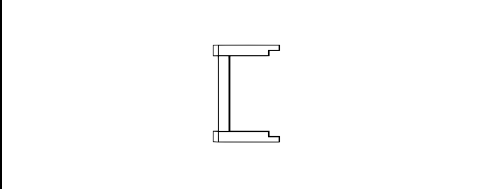
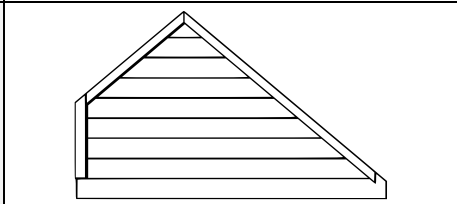
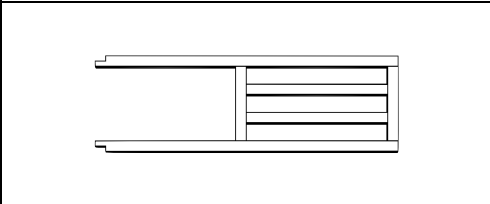
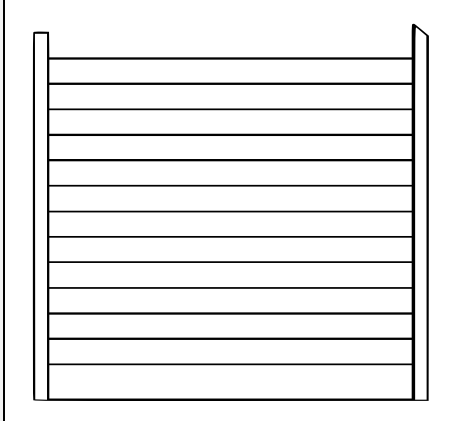
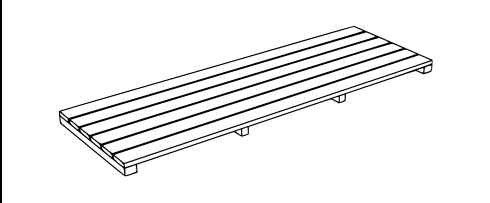
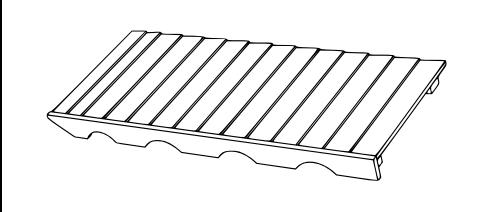
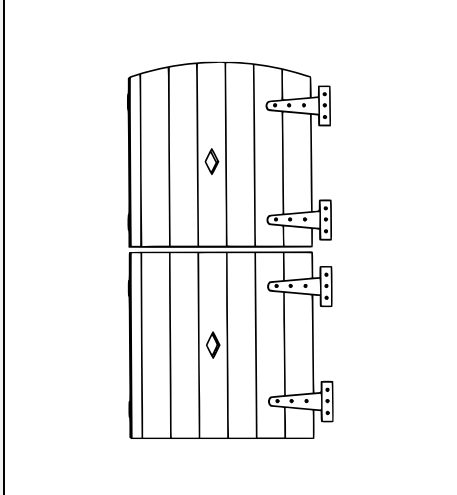
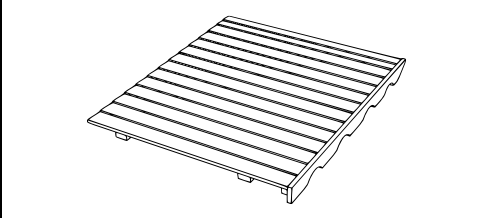
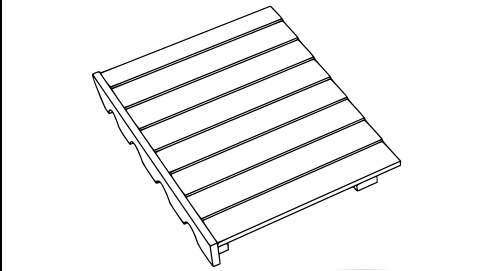

6		1		1	18		1
7		1			19		1
8		1			20		1
					21		2
					22		2
					23		2
					24	13-mm-Abstandhalter (13-mm-afstandshouder)	2
9		1					

A	B	C	D	E	F	G	H	I
3,5×60	3,5×50	3,0×30	3,0×25	3,0×20	3,0×16	3,5×24		
4	26	14	16	39	36	8	8	4

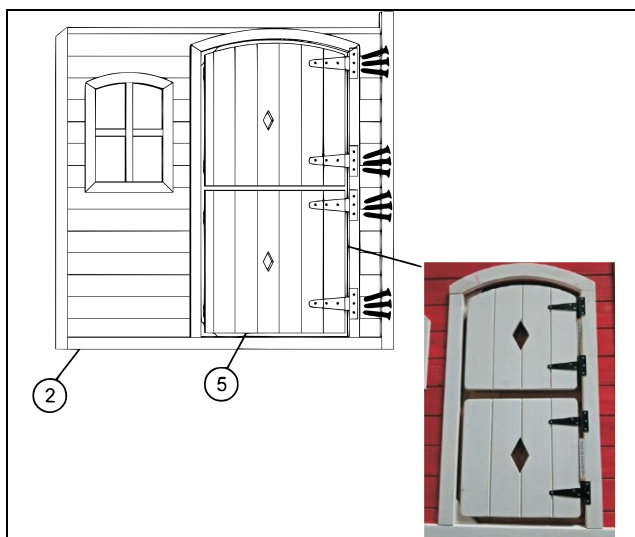

Stap 1 | F×12

Laat bij het monteren van de deur en van het raam een afstand van 13 mm vrij om te voorkomen dat uw vingers later bekneld raken.

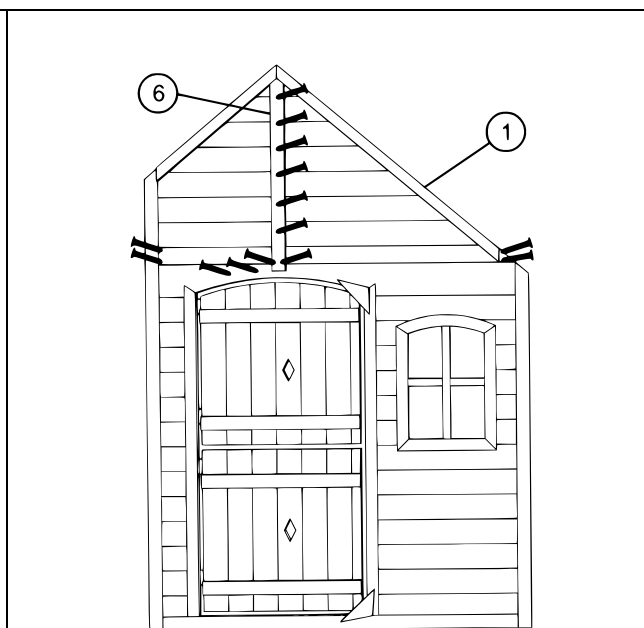

Stap 2 | E×14

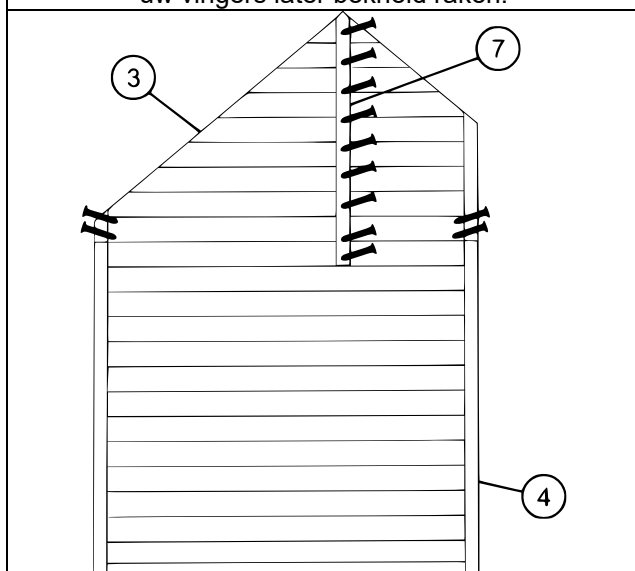

Stap 3 | E×13

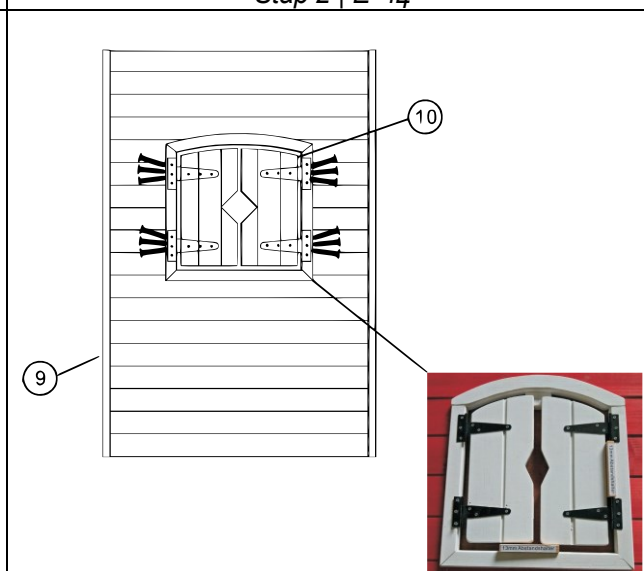

Stap 4 | F×12

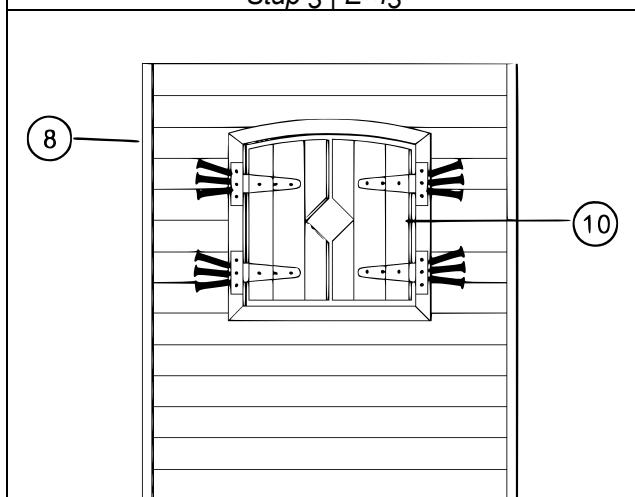

Stap 5 | F×12

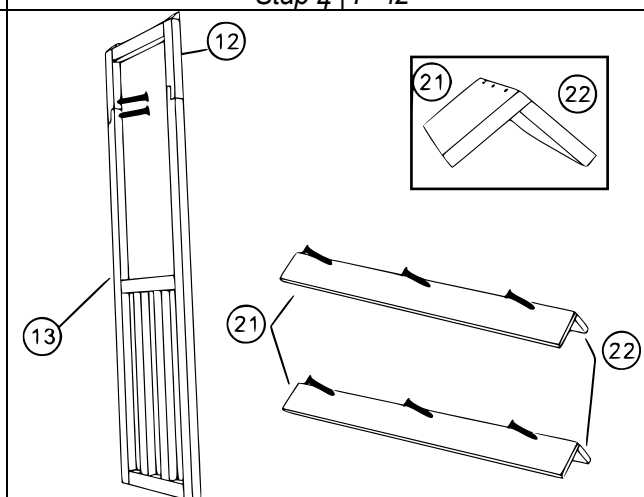

Stap 6 | C×8

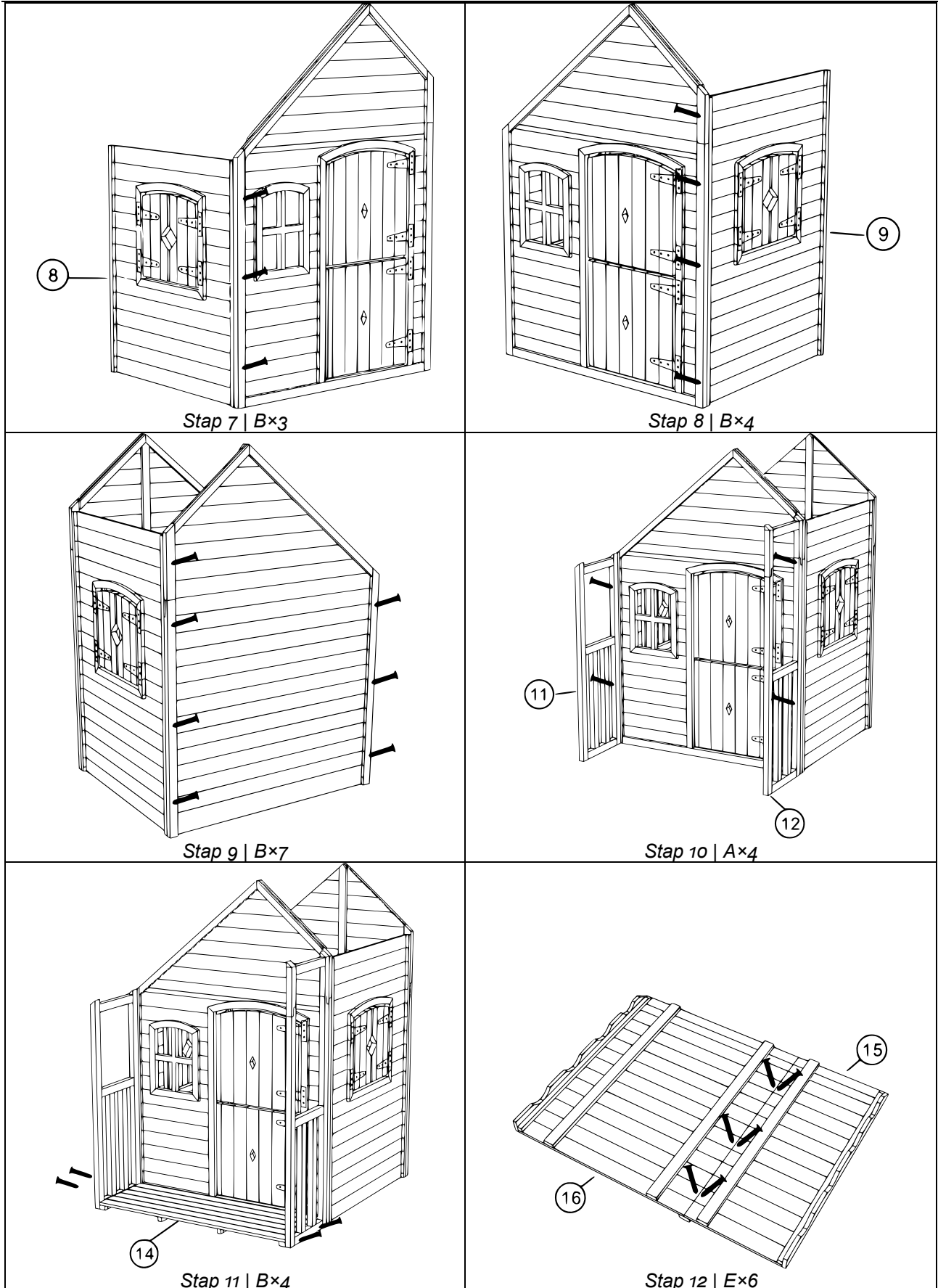

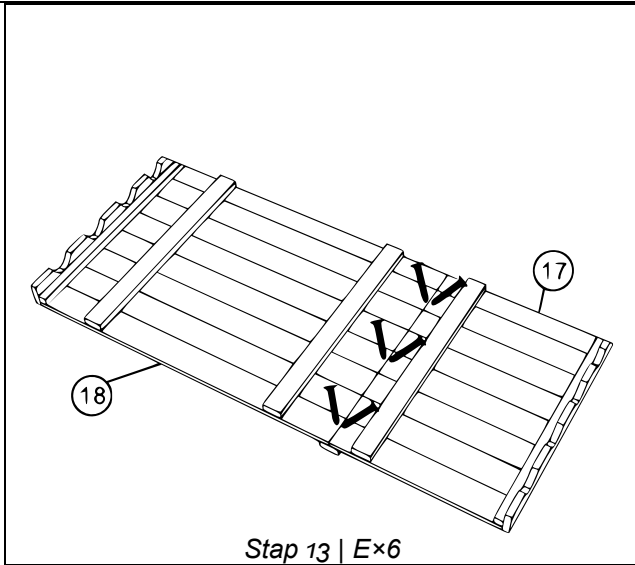

Stap 13 | E×6

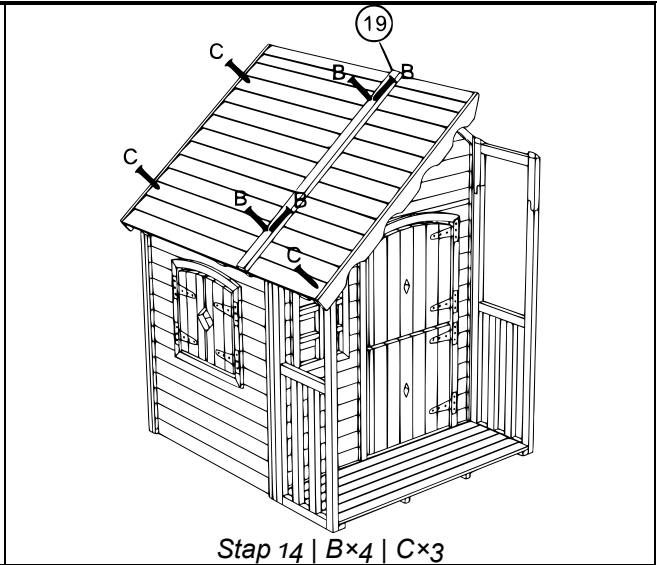

Stap 14 | B×4 | C×3

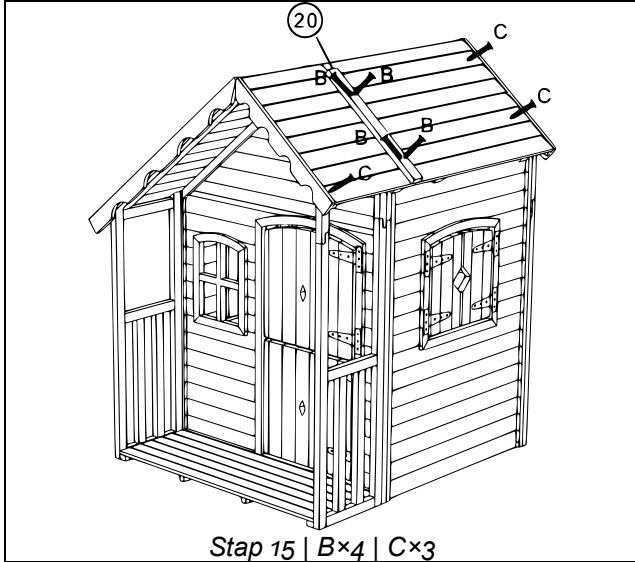

Stap 15 | B×4 | C×3

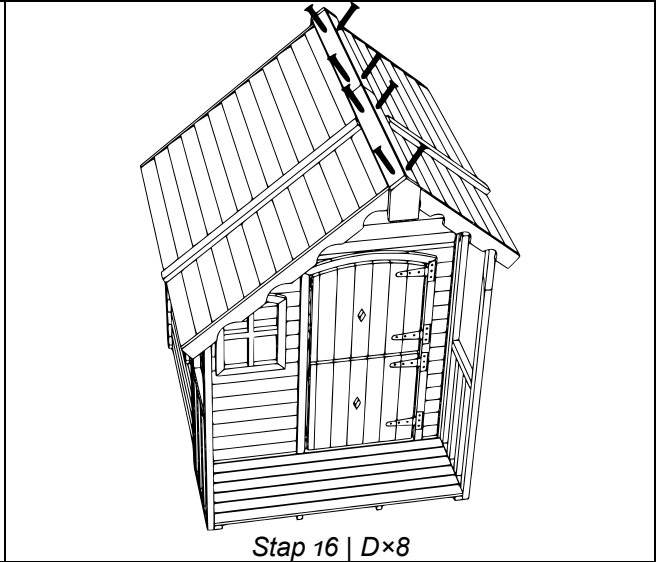

Stap 16 | D×8

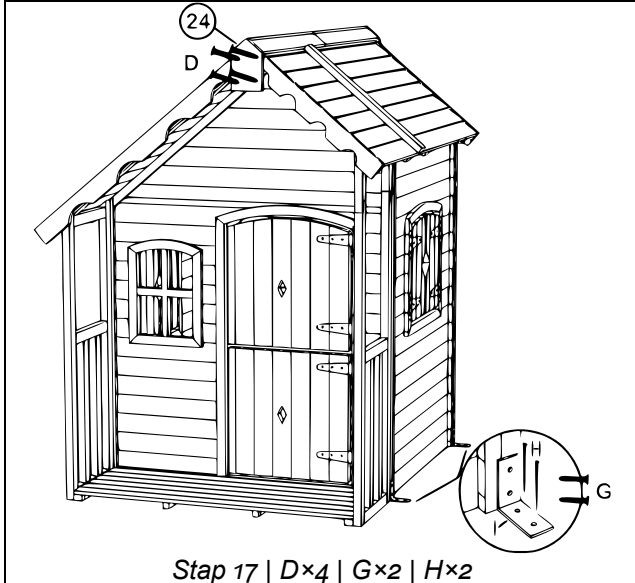

Stap 17 | D×4 | G×2 | H×2

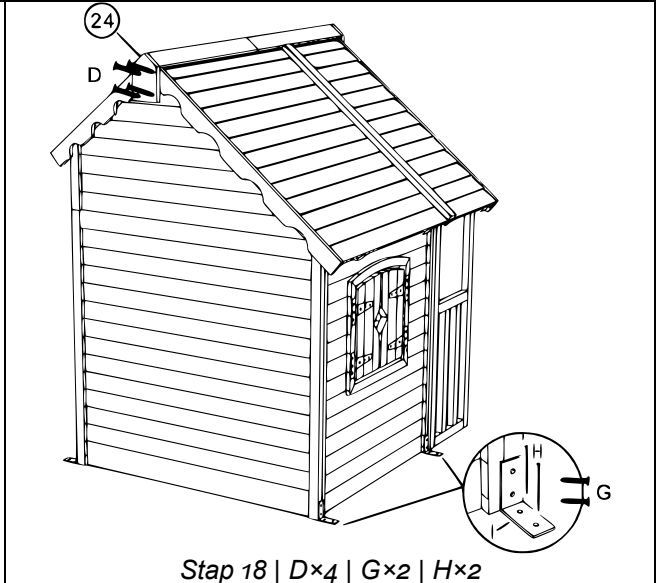

Stap 18 | D×4 | G×2 | H×2

Belangrijk:

Het op welke manier kopiëren van deze handleiding en /of gebruik ervan voor commerciële doeleinden, is alleen toegestaan met schriftelijke toestemming van *WilTec Wildanger Technik GmbH* vooraf.