

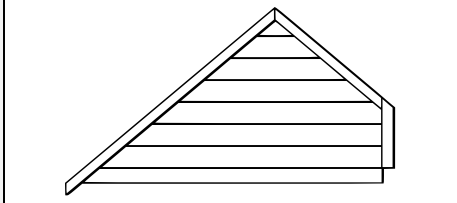

Nr.	Avbildning	Ant.	Nr.	Avbildning	Ant.
1		1	10		2
2		1	11		1
			12		1
3		1	13		1
4		1	14		1
			15		1
5		1	16		1
			17		1

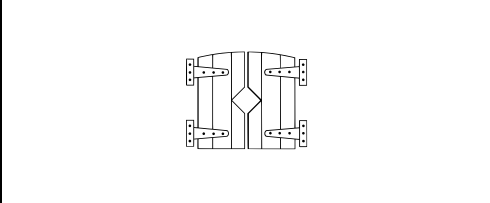
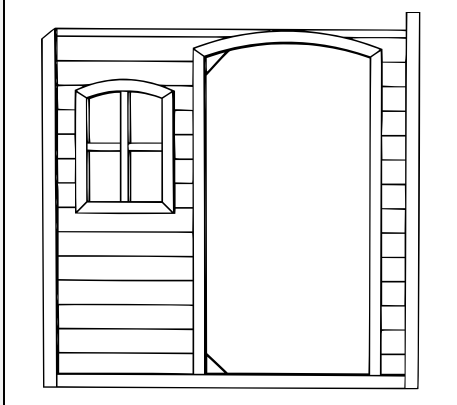
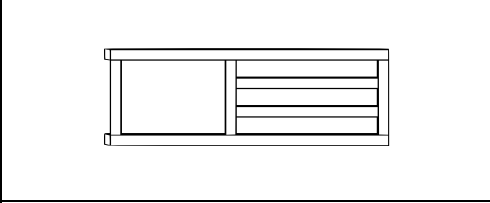
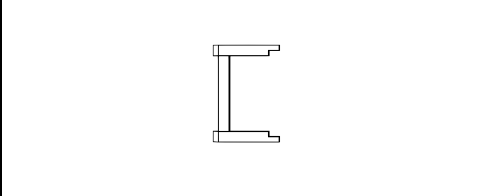
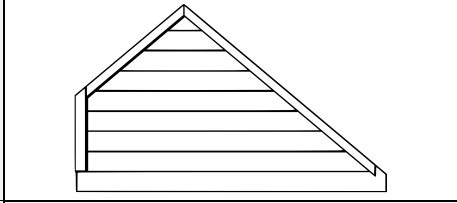
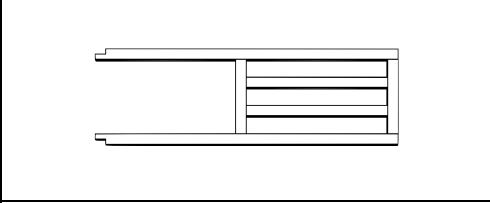
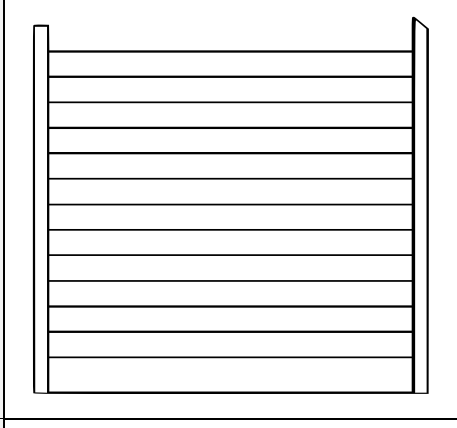
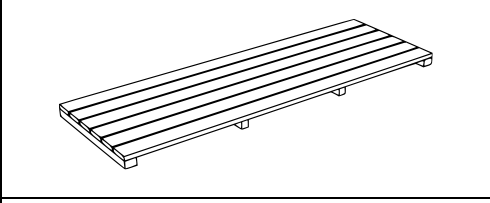
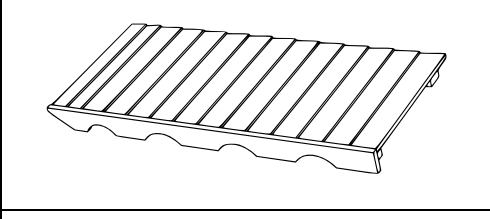
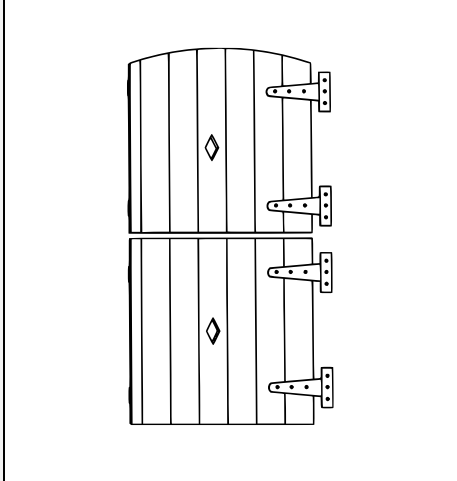
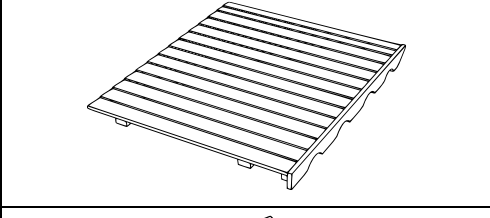
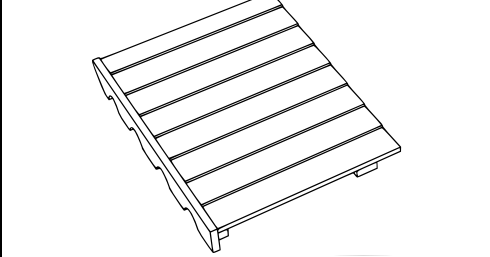

6		1		1	18		1
7		1			19		1
8		1			20		1
					21		2
					22		2
					23		2
					24	13-mm-Abstandhalter (13 mm distans)	2
					9		1

A	B	C	D	E	F	G	H	I
3,5×60	3,5×50	3,0×30	3,0×25	3,0×20	3,0×16	3,5×24		
4	26	14	16	39	36	8	8	4

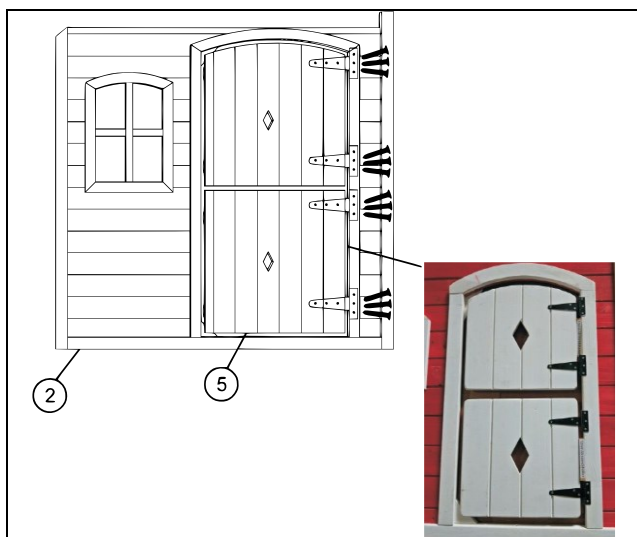

Steg 1 | F×12

När du monterar dörr och fönster, lämna ett mellanrum på 13 mm för att undvika att klämma fingrarna senare.

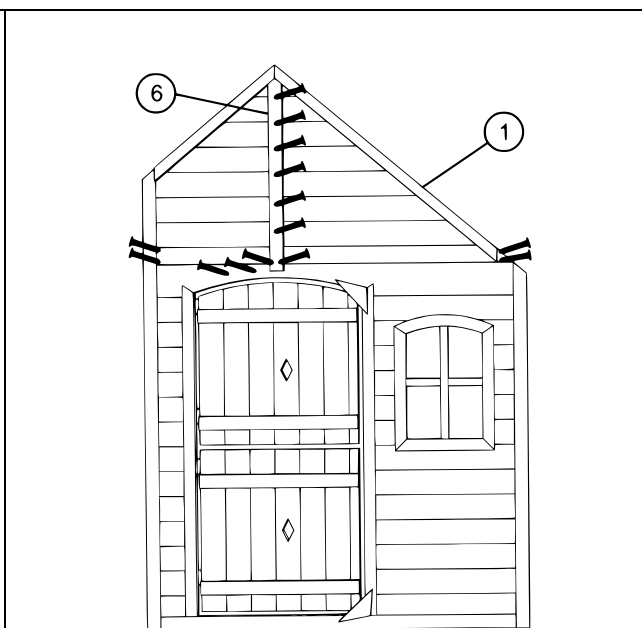

Steg 2 | E×14

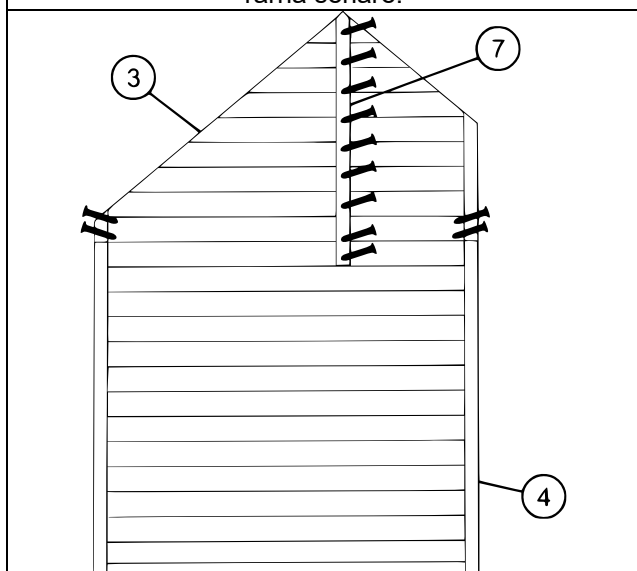

Steg 3 | E×13

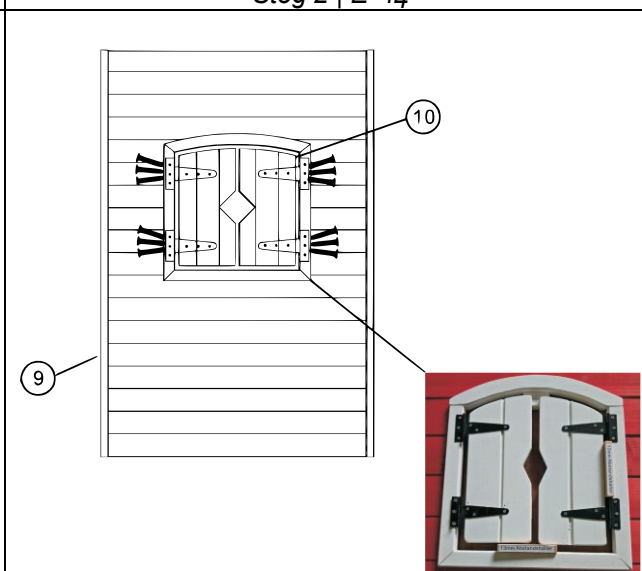

Steg 4 | F×12

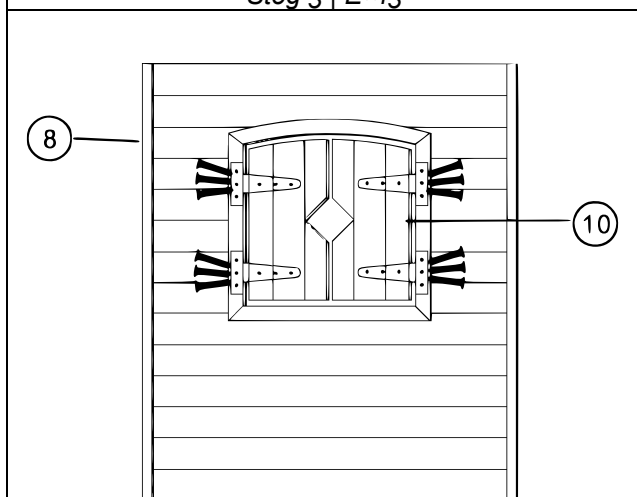

Steg 5 | F×12

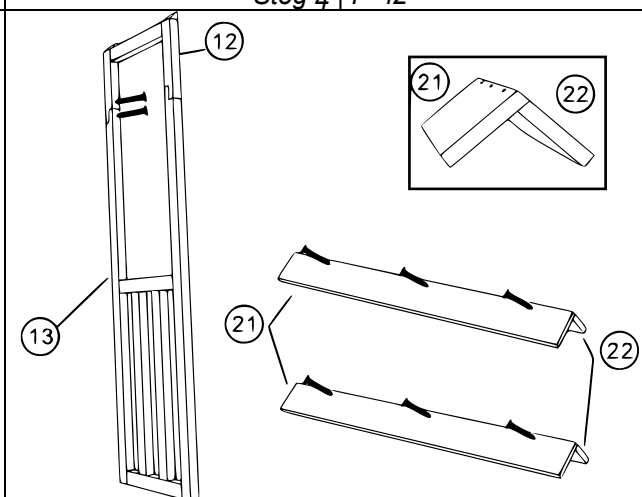

Steg 6 | C×8

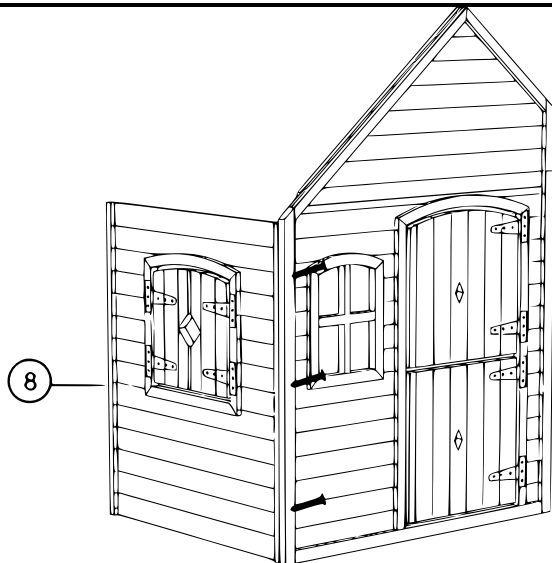

Steg 7 | B×3

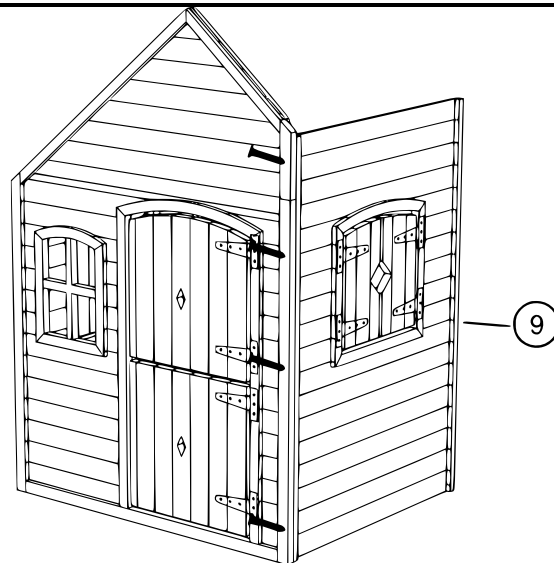

Steg 8 | B×4

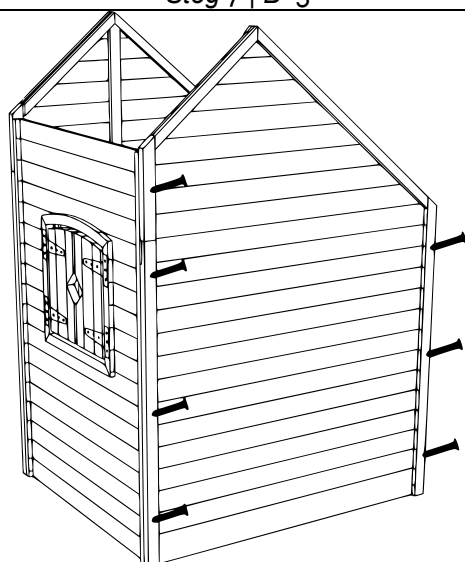

Steg 9 | B×7

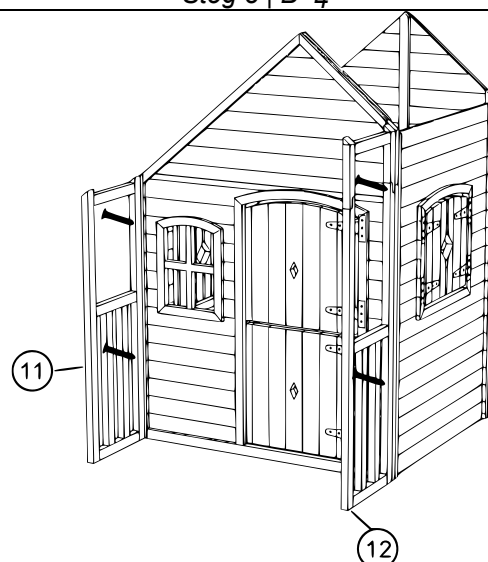

Steg 10 | A×4

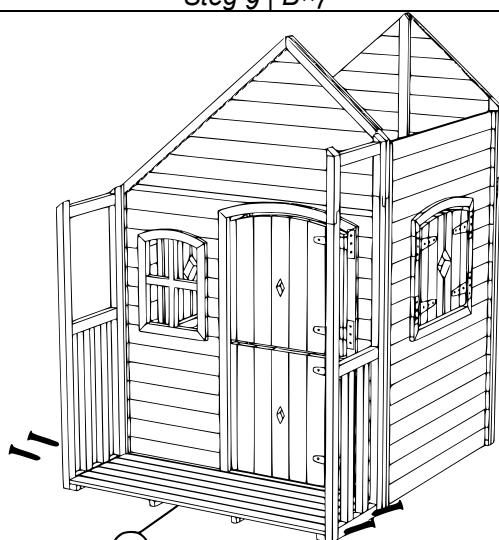

Steg 11 | B×4

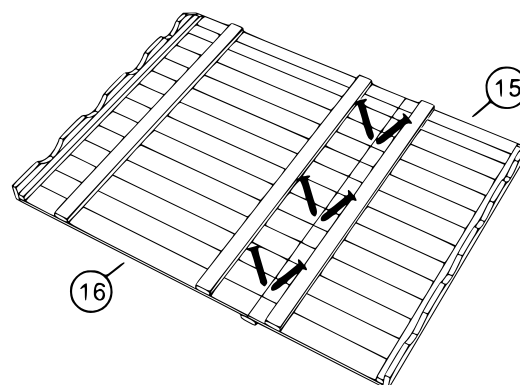

Steg 12 | E×6

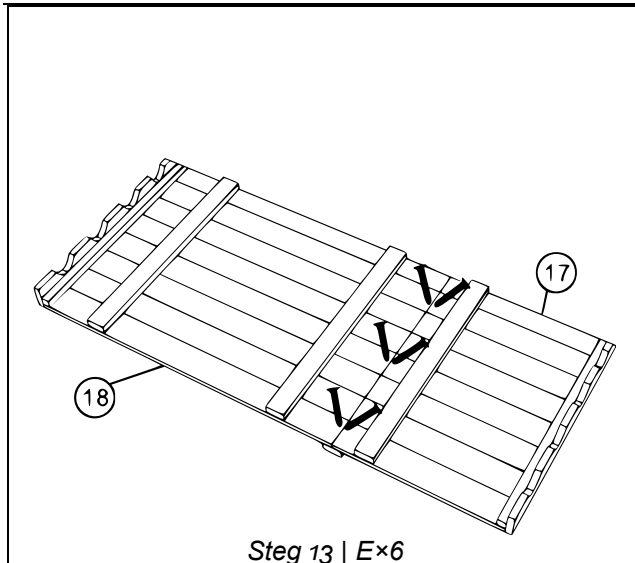

Steg 13 | E×6

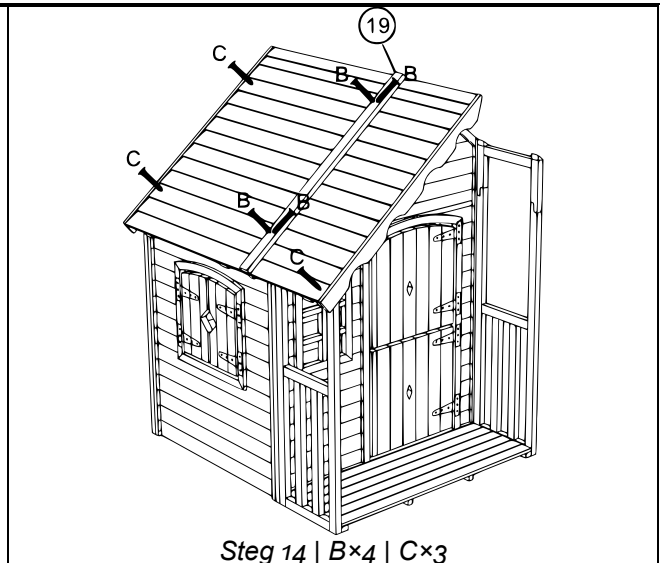

Steg 14 | B×4 | C×3

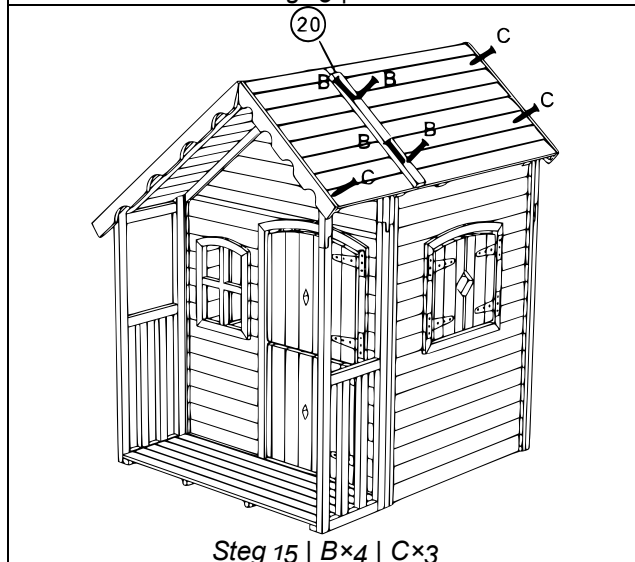

Steg 15 | B×4 | C×3

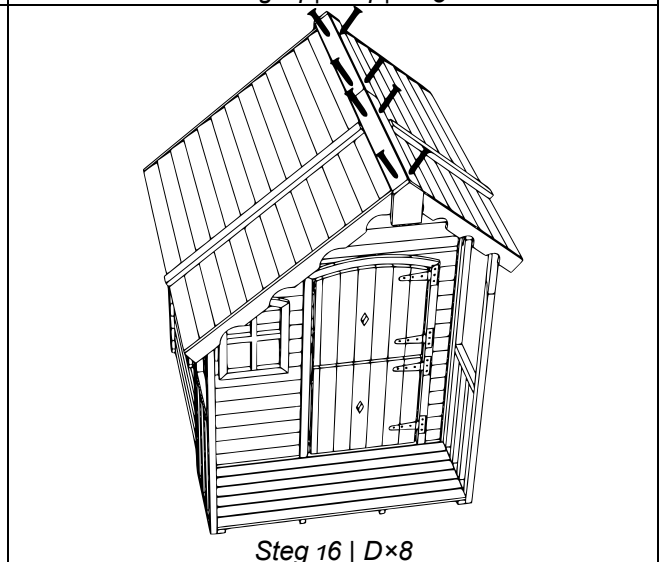

Steg 16 | D×8

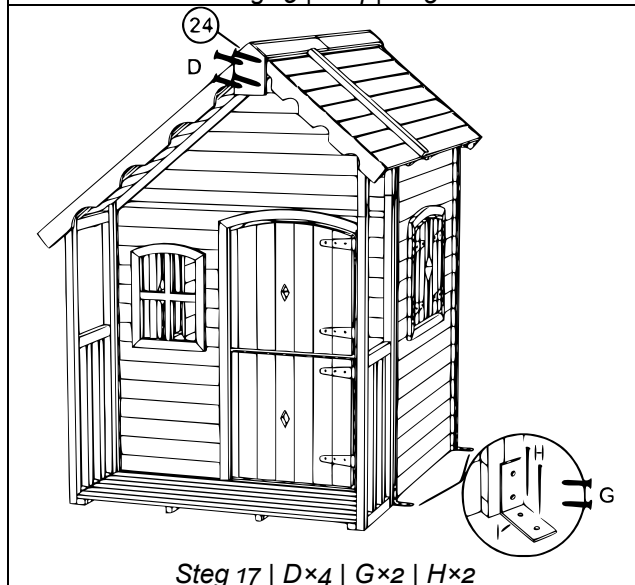

Steg 17 | D×4 | G×2 | H×2

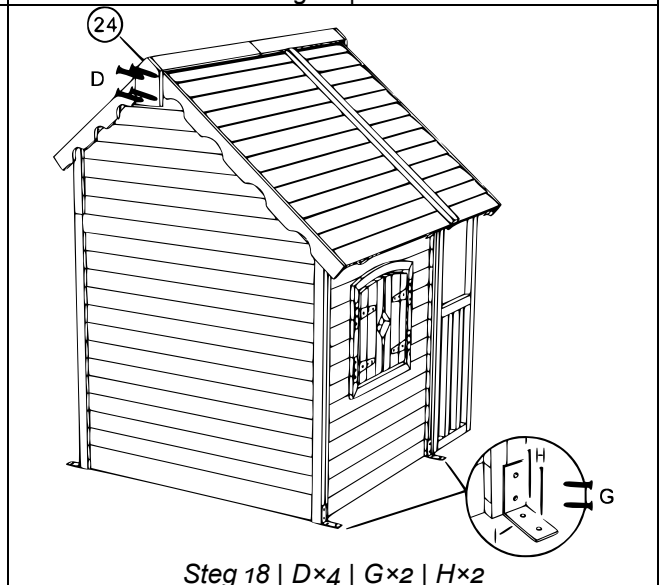

Steg 18 | D×4 | G×2 | H×2

Viktig anmärkning:

Varje sätt av delvis eller fullständigt mångfaldigande eller kommersiellt nyttjande av denna bruksanvisning behöver ett skriftligt godkännande från WilTec Wildanger Technik GmbH.