

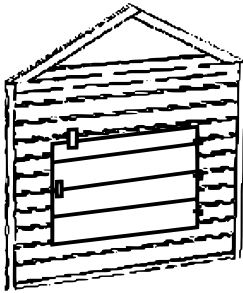

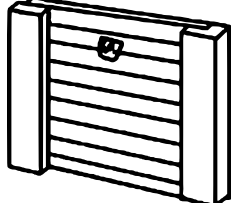

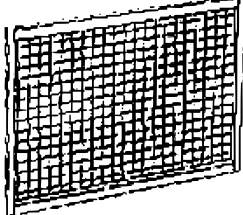

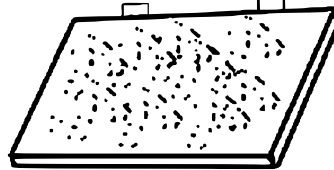

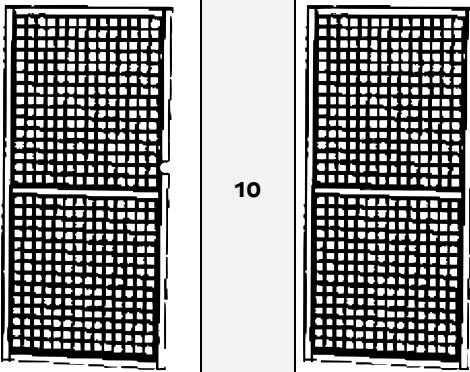

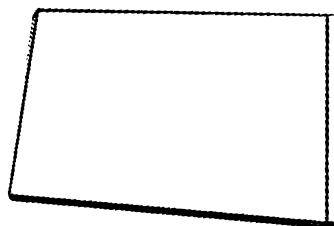
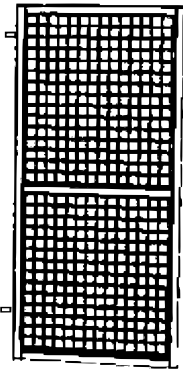

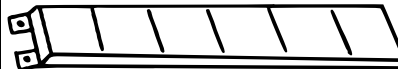



Nr.	Abbildung	Anz.	Nr.	Abbildung	Anz.
1		1	12		2
2		1	13		1
3		1	14		2
4		1	15		1
5		1	16		1
6		1	17		1

AUFBAUANLEITUNG 51960

7		1	18		1
8		1	19		
9		1	20		1
			21		2
11		2	22		2
			23		1
			24		2

			
A 3,5×50 40	B 3,5×35 18	C 3,5×25 20	D 3,0×16 10
			
E M6×60 8	G 2	H 1	J 1

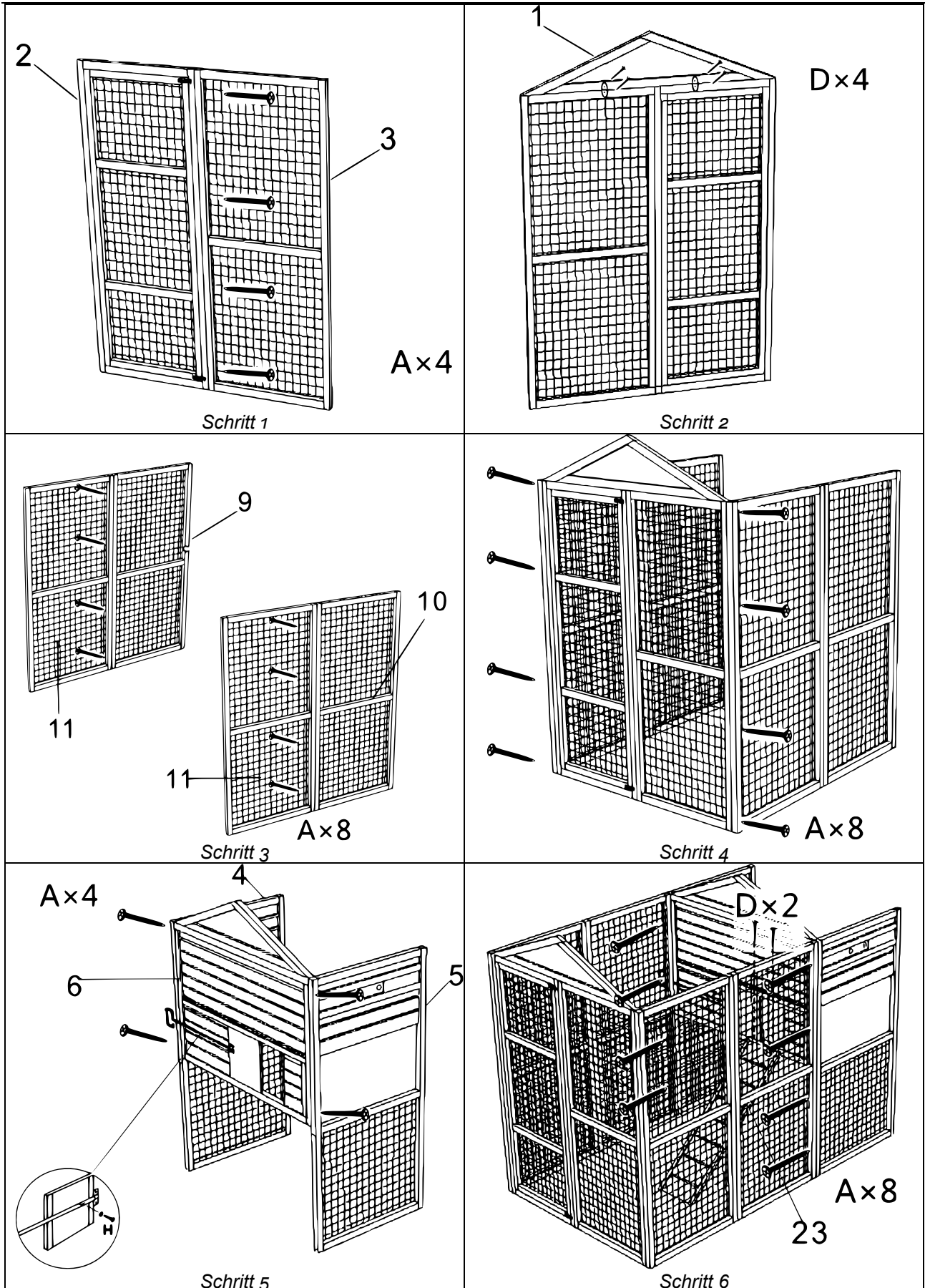

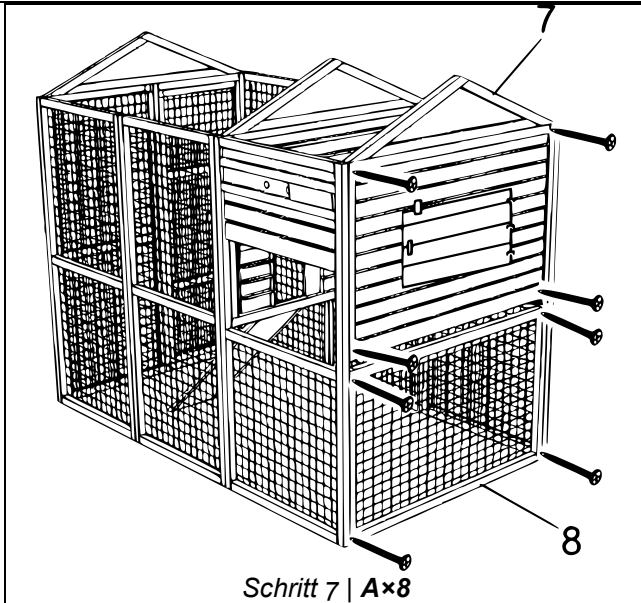

Schritt 7 | A×8

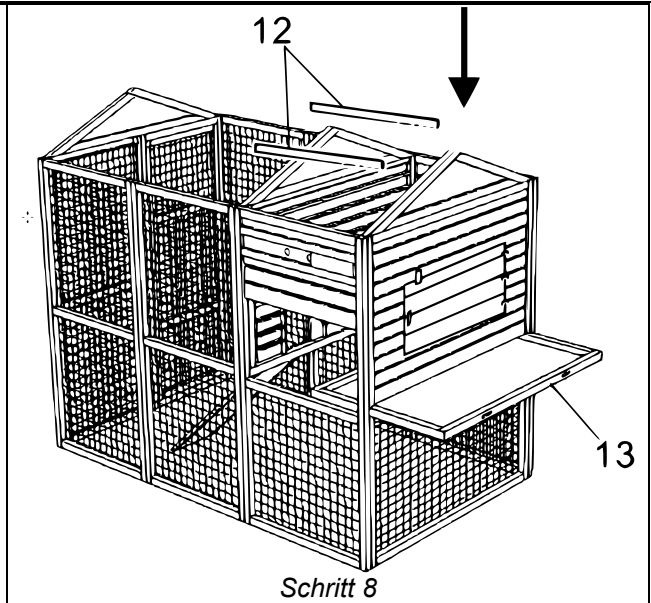

Schritt 8

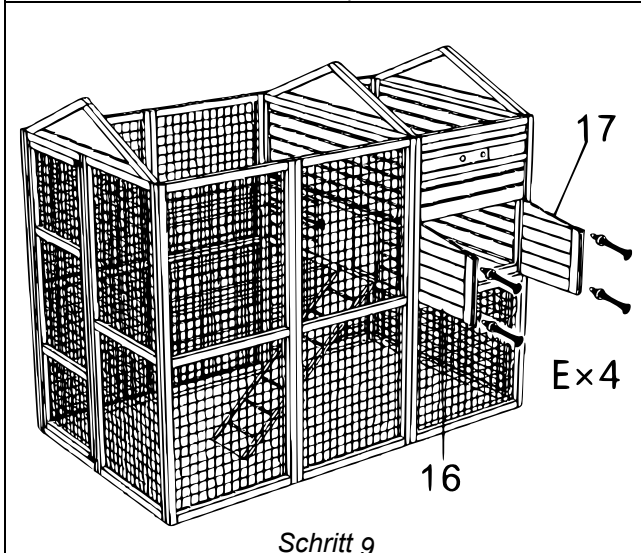

Schritt 9

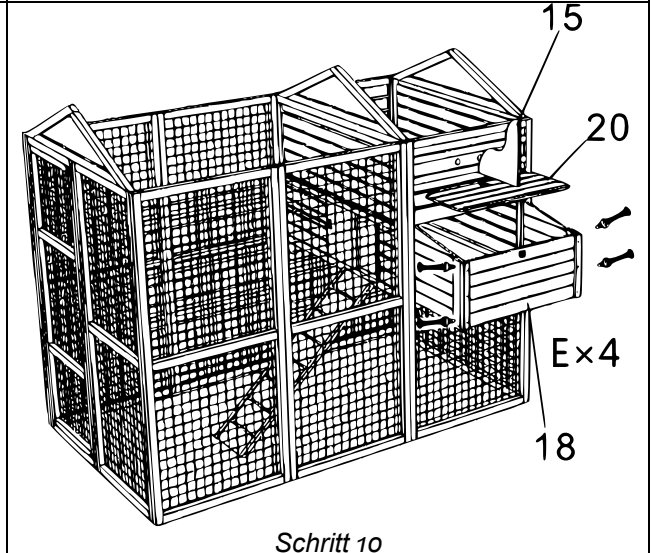

Schritt 10

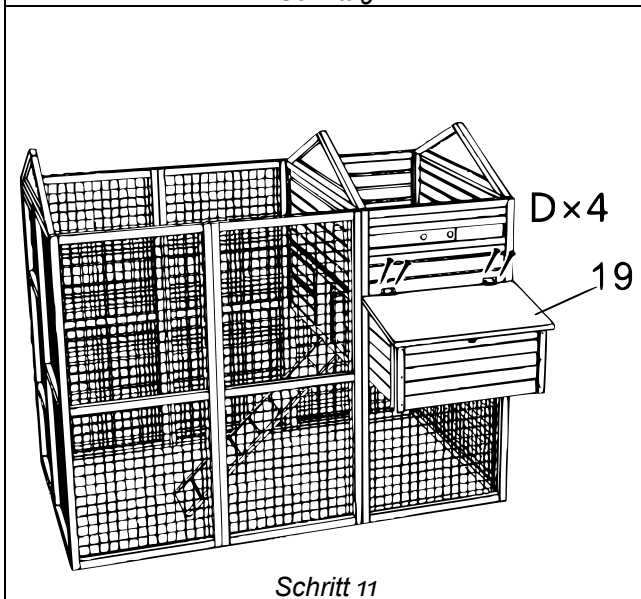

Schritt 11

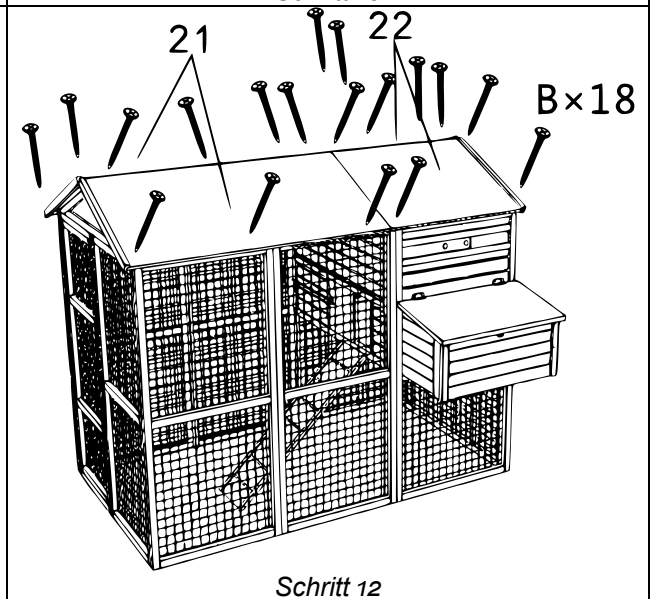

Schritt 12

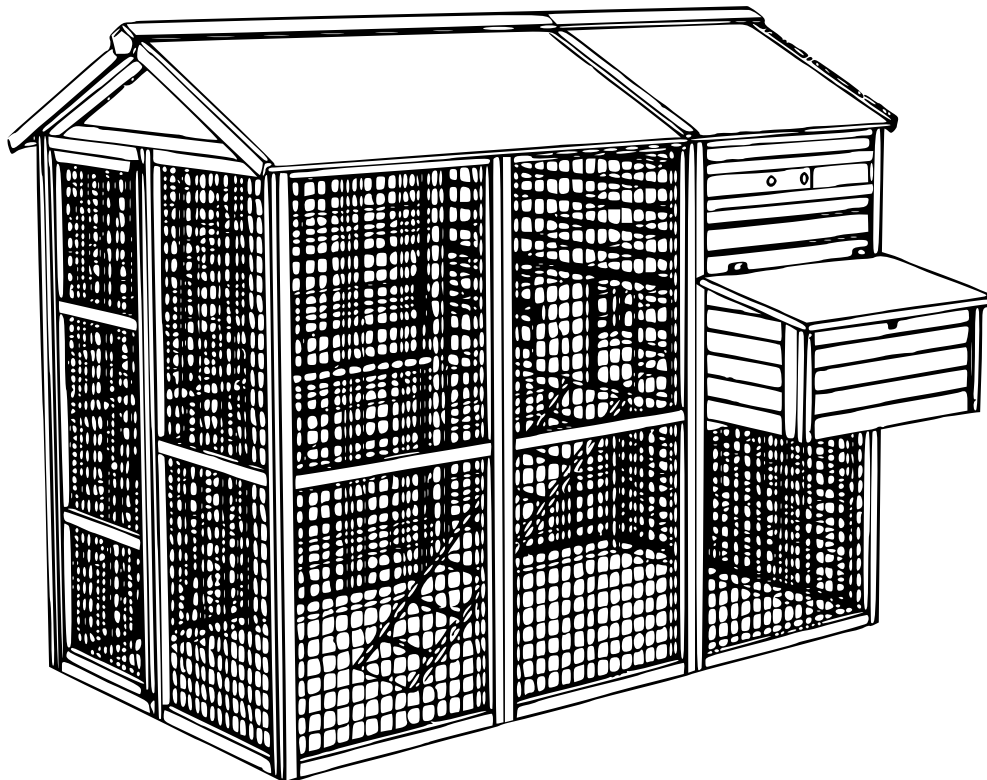
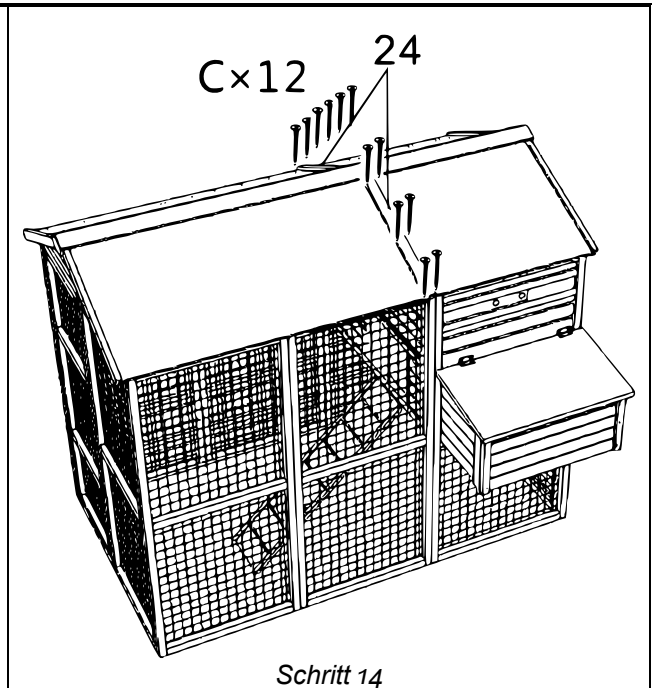
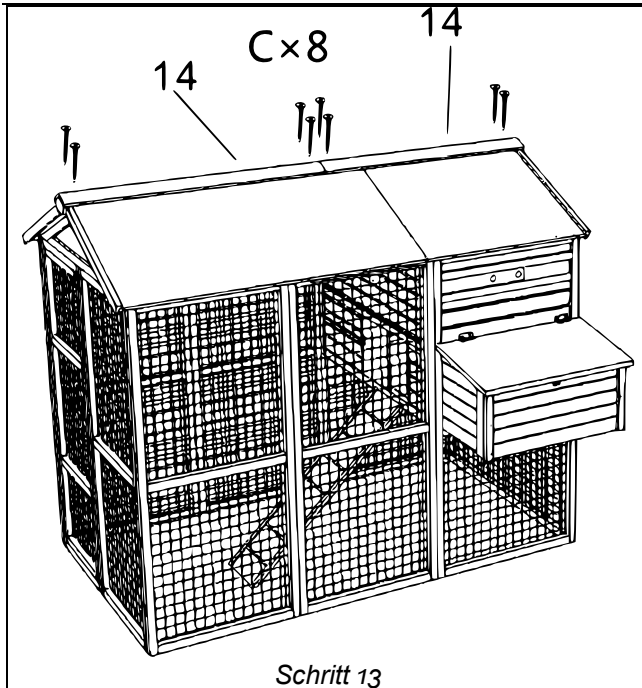

Wichtiger Hinweis:

Nachdruck, auch auszugsweise, und jegliche kommerzielle Nutzung, auch von Teilen der Anleitung, nur mit schriftlicher Genehmigung, der WilTec Wildanger Technik GmbH.