











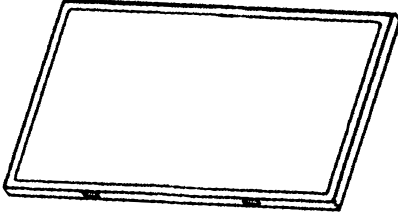
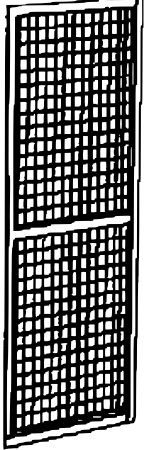

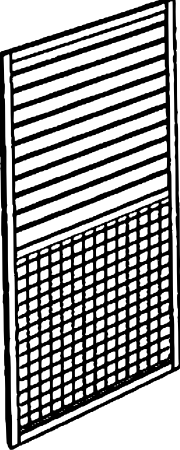
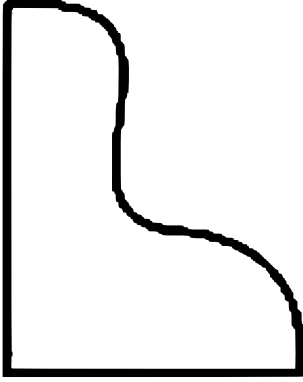
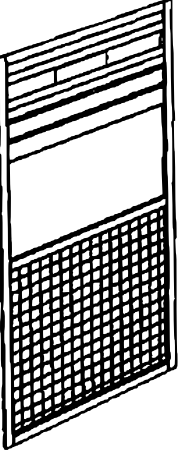
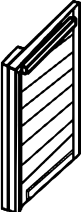
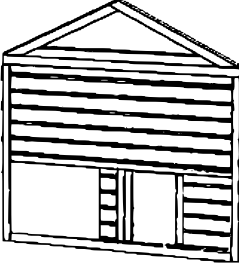
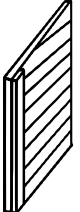
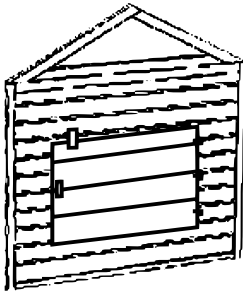
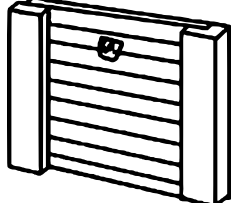
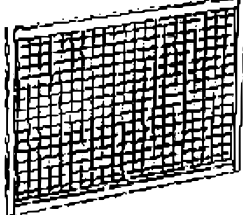
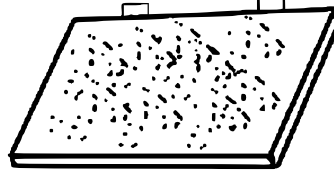
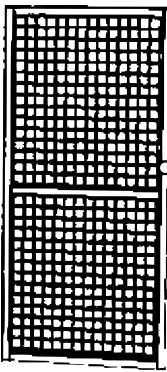

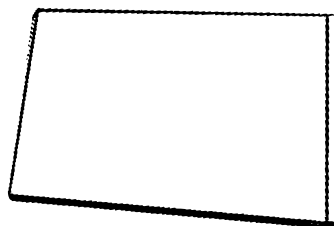
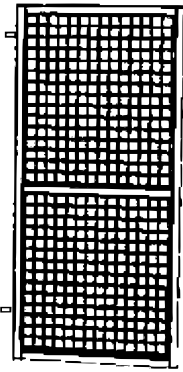

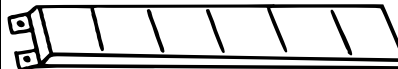



No	Figure	Qty.	No	Figure	Qty.
1		1	12		2
2		1	13		1
3		1	14		2
4		1	15		1
5		1	16		1
6		1	17		1



7		1	18		1	
8		1	19			
9		10	1	20		1
				21		2
11			2	22		2
				23		1
				24		2

			
A 3.5×50 40	B 3.5×35 18	C 3.5×25 20	D 3.0×16 10
			
E M6×60 8	G 2	H 1	J 1



<p>2</p> <p>3</p> <p>A x 4</p> <p>Step 1</p>	<p>1</p> <p>D x 4</p> <p>Step 2</p>
<p>9</p> <p>10</p> <p>11</p> <p>11</p> <p>A x 8</p> <p>Step 3</p>	<p>A x 8</p> <p>Step 4</p>
<p>A x 4</p> <p>4</p> <p>6</p> <p>5</p> <p>Step 5</p>	<p>D x 2</p> <p>A x 8</p> <p>23</p> <p>Step 6</p>

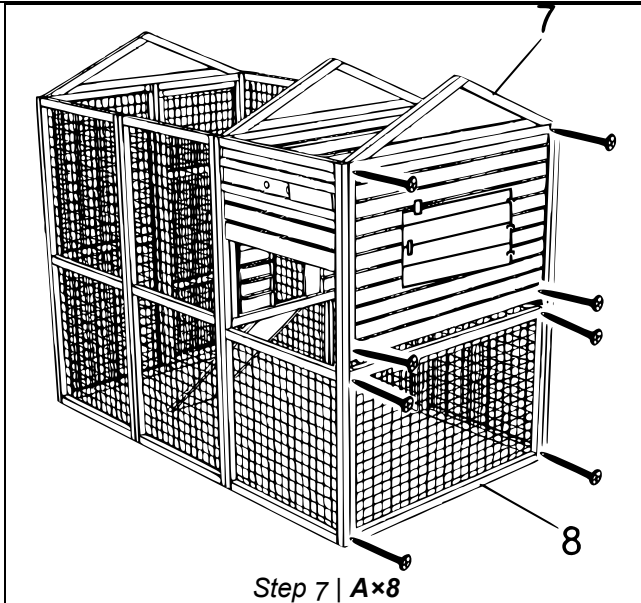

Step 7 | A×8

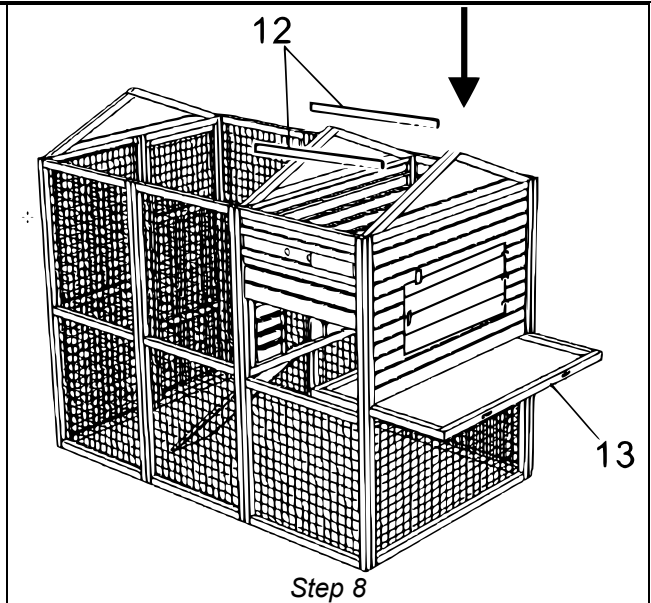

Step 8

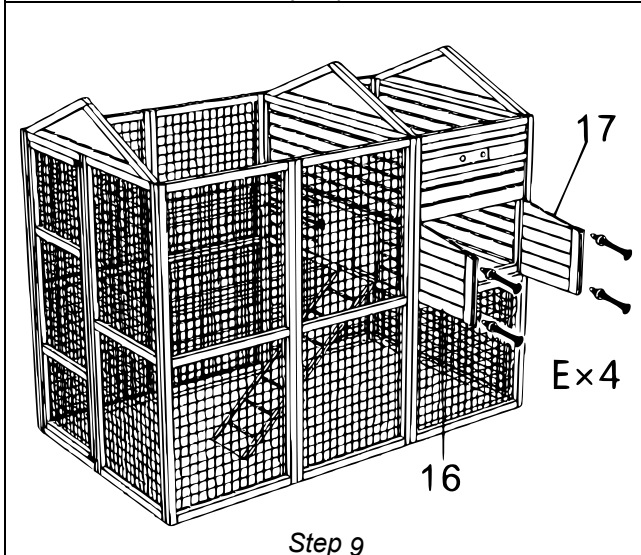

Step 9

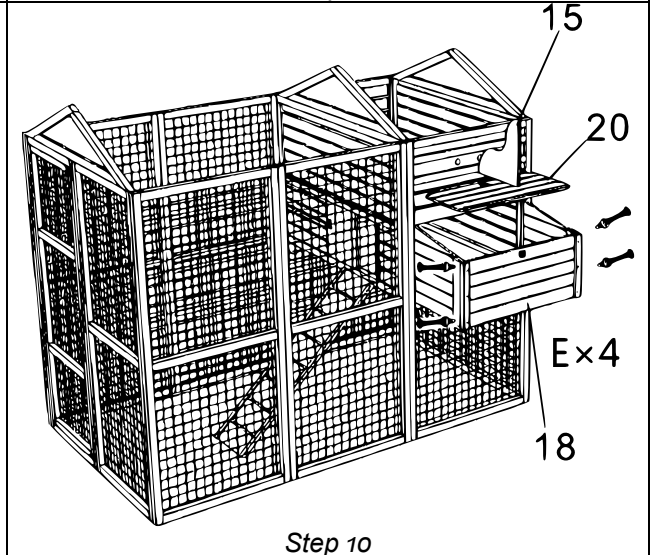

Step 10

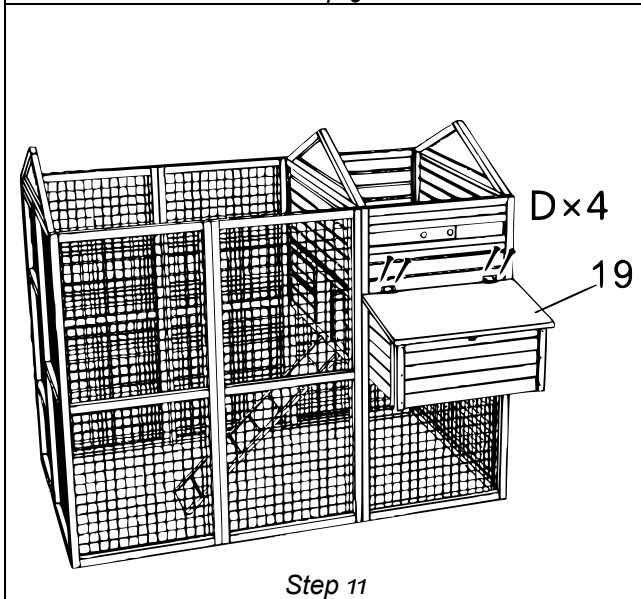

Step 11

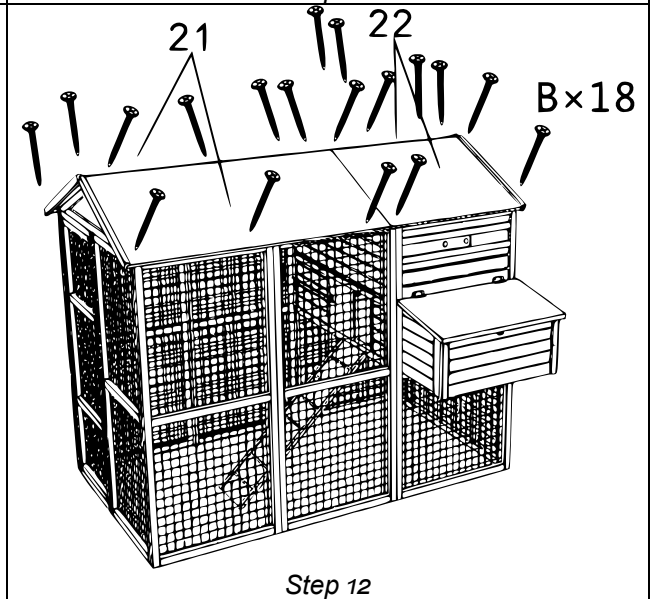

Step 12

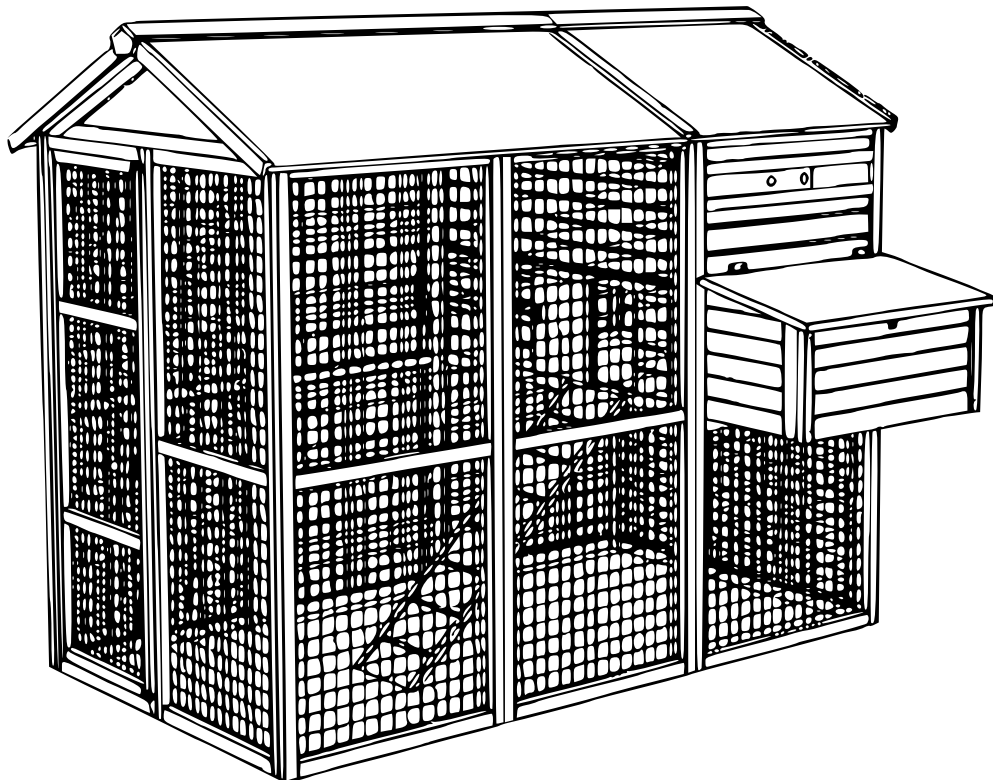
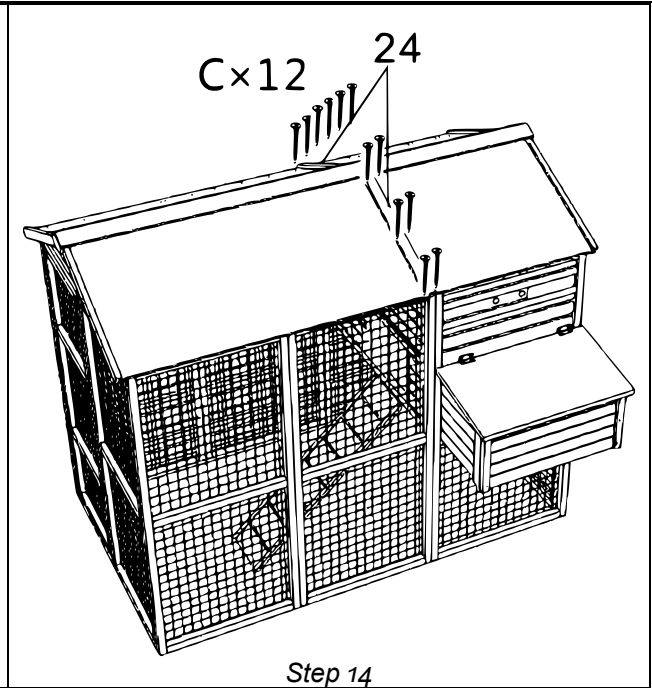
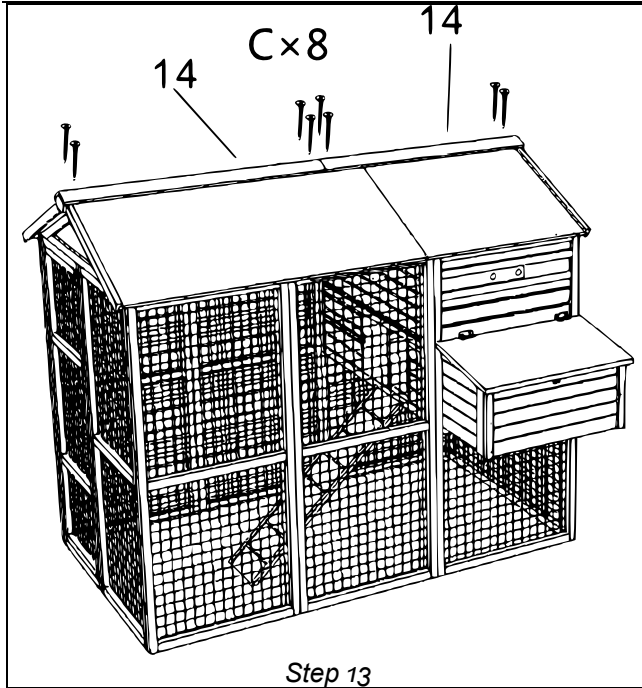

Important notice:

The reprint or reproduction, even of excerpts, and any commercial use, even in part, of this instruction manual require the written permission of WilTec Wildanger Technik GmbH.