

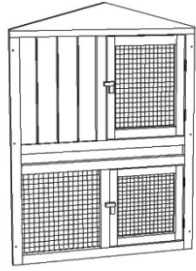







No	Figure	Qty.	No	Figure	Qty.
1		1	8		4
2		1	9		1
3		1	10		1
4		1	11		2
5		2	12		1
6		2	13		1

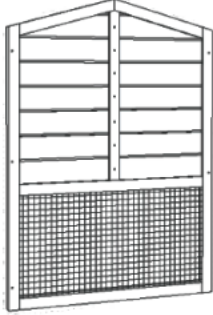
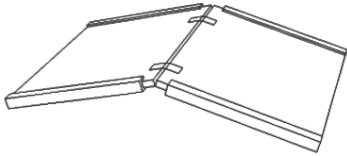

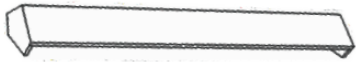
7		2	14		1
---	--	---	----	--	---

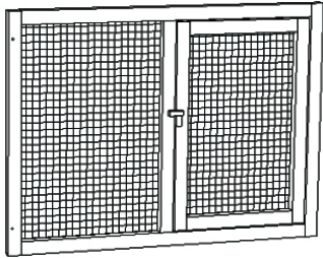
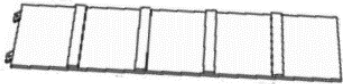
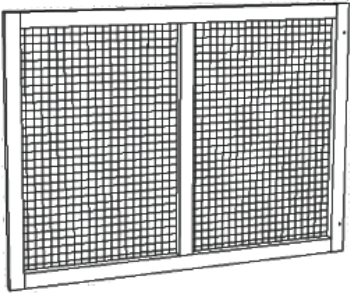
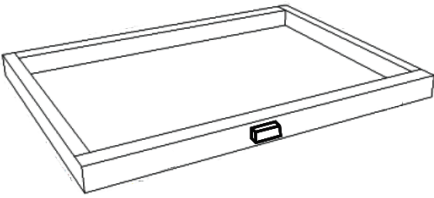
A	B	C	D	E	F
 3.5×50	 3.5×40	 3.5×35	 3.0×25	 3.0×16	 6.0×20
8	16	24	12	2	20

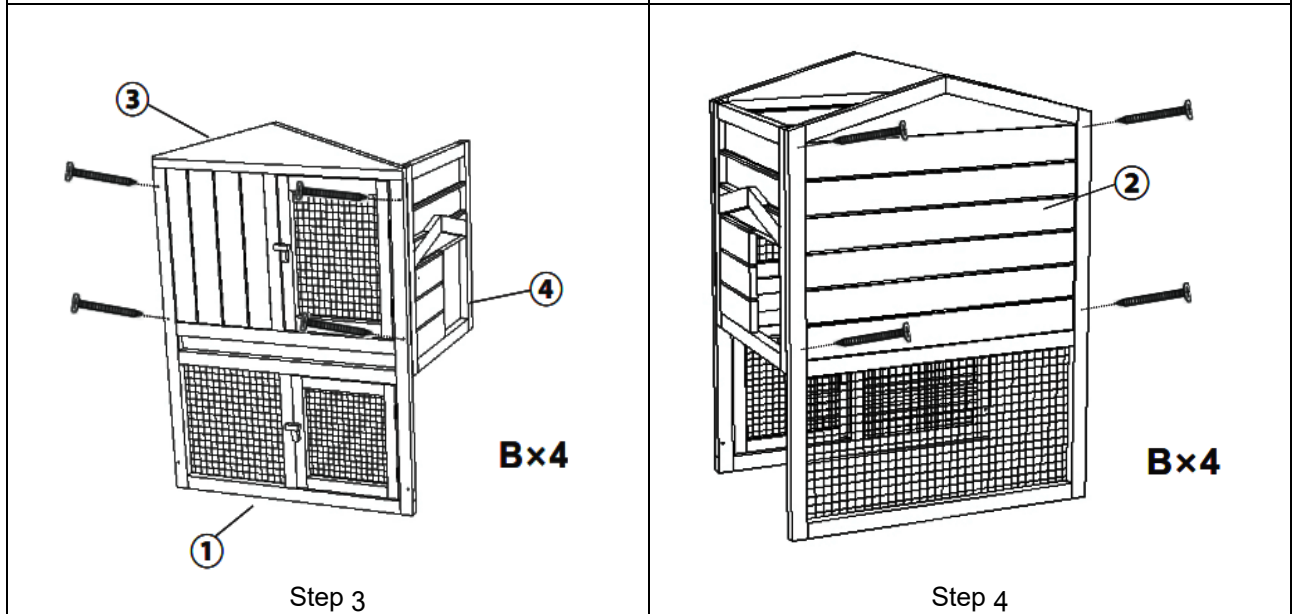
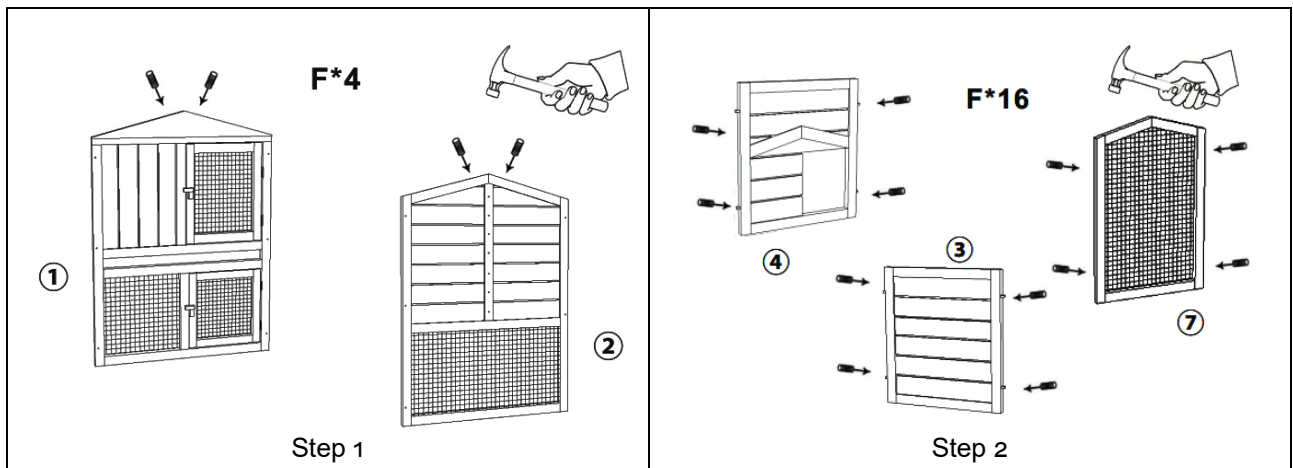



<p>E×2</p> <p>Step 5</p>	<p>A×4</p> <p>Step 6</p>
<p>B×4</p> <p>Step 7</p>	<p>A×4</p> <p>Step 8</p>
<p>B×4</p> <p>Step 9</p>	<p>C×16</p> <p>Step 10</p>

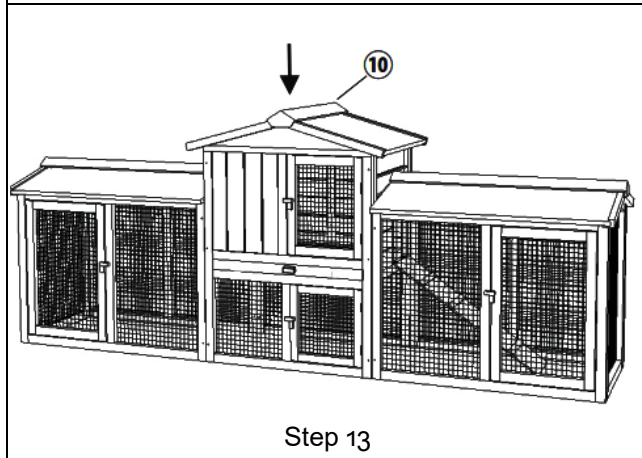
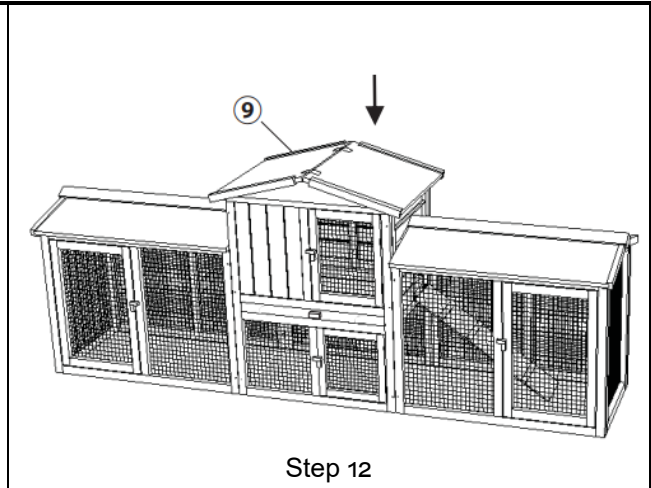
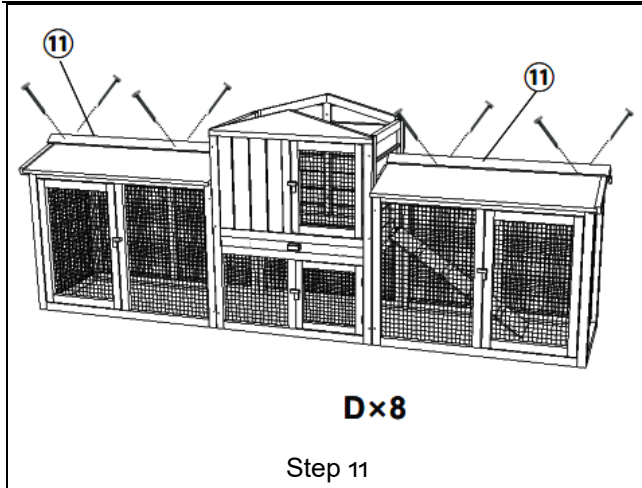

Important Note:

Reproduction and any commercial use (of parts) of this operating manual, requires a written permission of WilTec Wildanger Technik GmbH.