

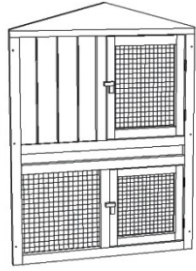





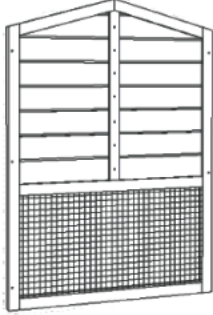
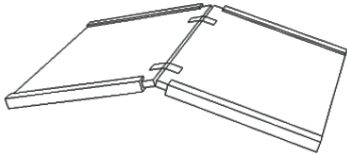

Nr.	Avbildning	Ant.	Nr.	Avbildning	Ant.
1		1	8		4
2		1	9		1
3		1	10		1
4		1	11		2
5		2	12		1
6		2	13		1

7		2	14		1
---	--	---	----	--	---

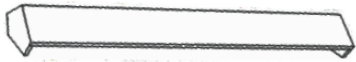
A	B	C	D	E	F
 3,5×50	 3,5×40	 3,5×35	 3,0×25	 3,0×16	 6,0×20
8	16	24	12	2	20

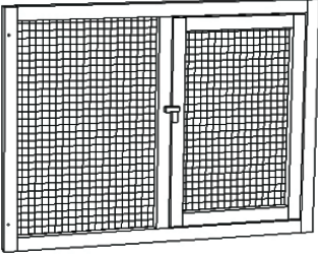
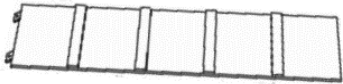
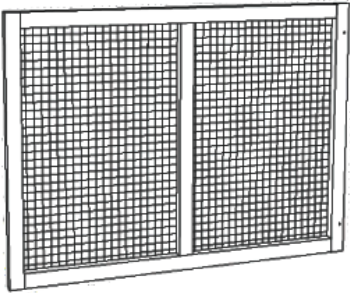
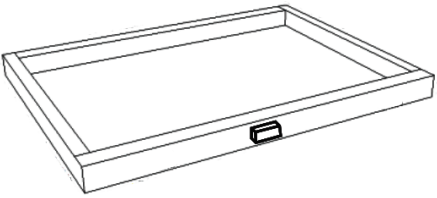
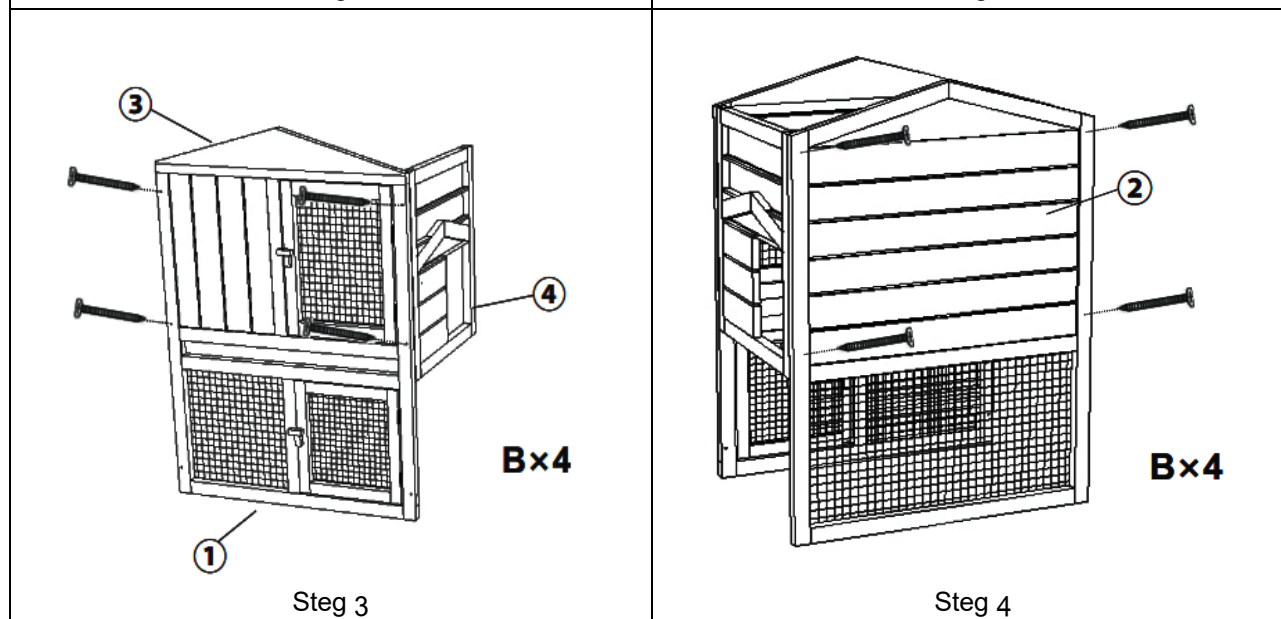
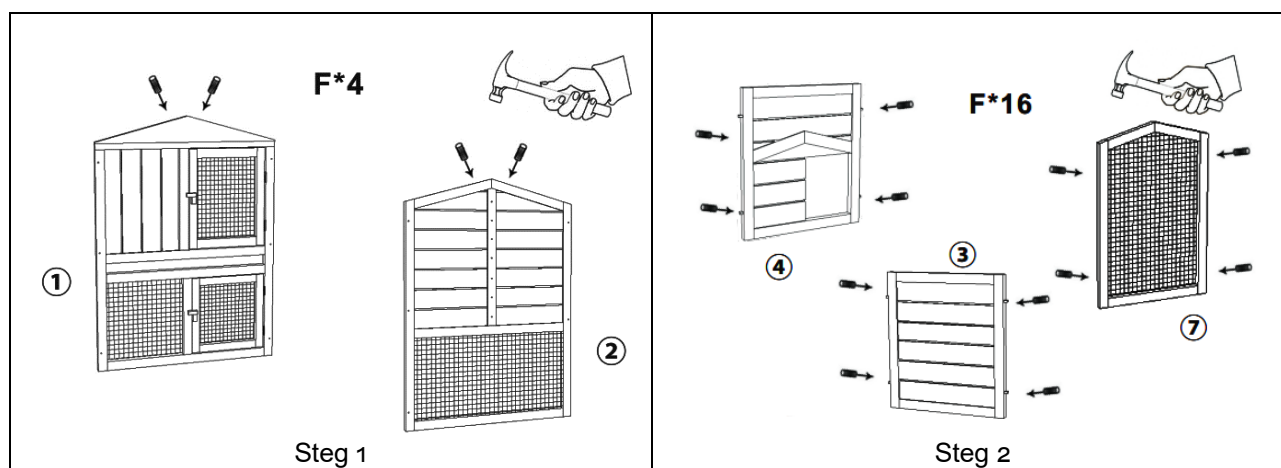

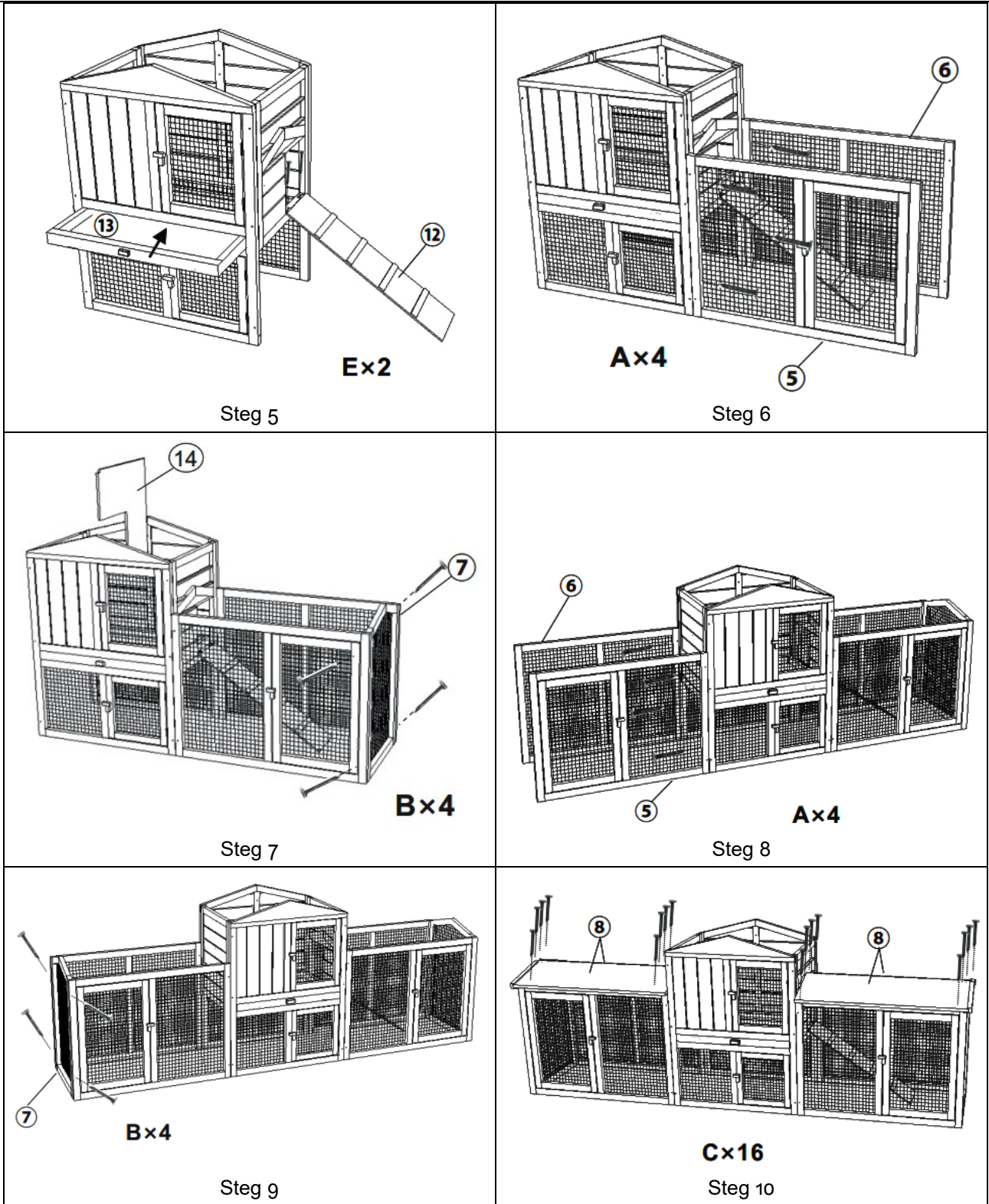

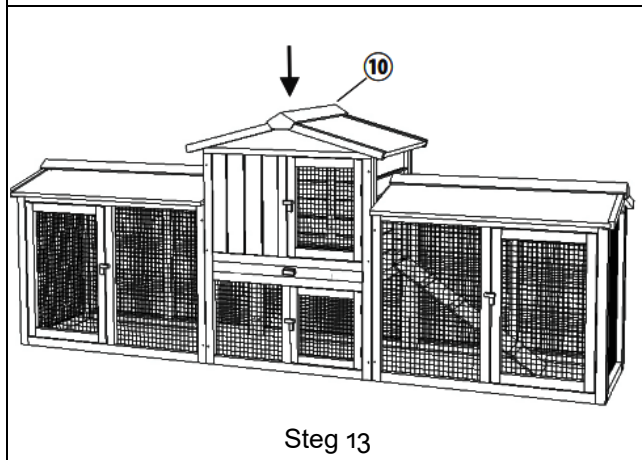
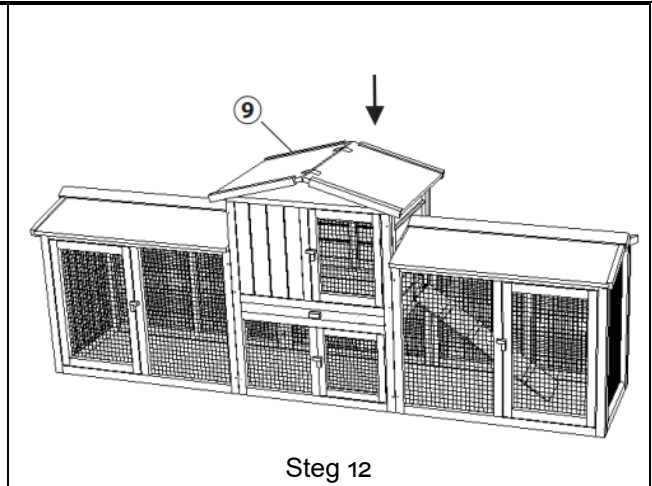
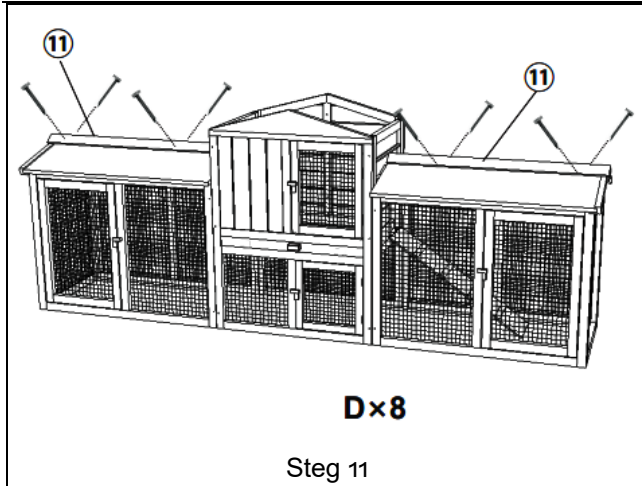

Viktig anmärkning:

Varje sätt av delvis eller fullständigt mångfaldigande eller kommersiellt nyttjande av denna bruksanvisning behöver ett skriftligt godkännande från WilTec Wildanger Technik GmbH.