

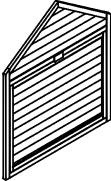

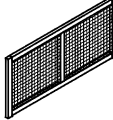







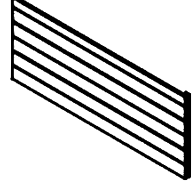
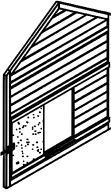
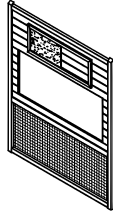
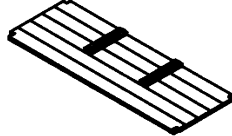
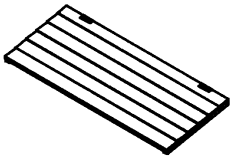
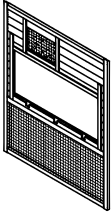
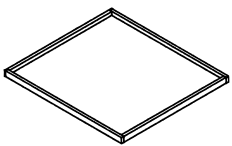

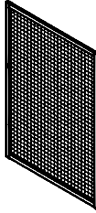

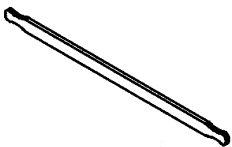
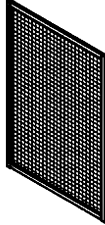
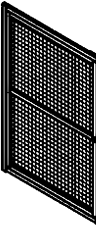
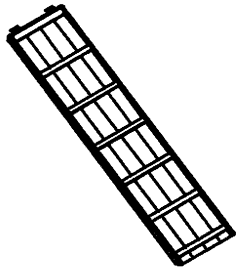
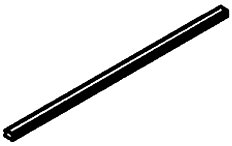
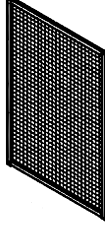
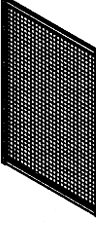

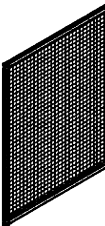
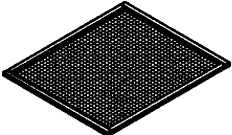





No	Fig./Name	No	Fig./Name	No	Fig./Name	No	Fig./Name
1	 Rear house panel	2	 Rear run panel	13	 Right nest box panel (2)	14	 Front nest box panel (2)
3	 Front house panel	4	 Left house panel	15	 Bottom nest box panel (2)	16	 Nest box roof (2)
5	 Right house panel	6	 Metal tray	17	 Divider (4)	18	 Left run panel
7	 House roof (2)	8	 Supporting rod (2)	19	 Right run panel (2)	20	 Left run panel (to be opened)
9	 Ramp	10	 Perch (3)	21	 Left run panel	22	 Right run panel
11	 Ridge	12	 Left nest box panel	23	 Front nest box panel	24	 Upper run panel (3)



A	B	C	D
 Bolt M6×2	 Bolt M6×1¼	 Screw M4×2	 Screw M4×1¾
8	8	12	18
E	F	G	H
 Screw M4×¾	 Screw M3×5/8	 Bolt M4×½	
4	22	1	1
I	J	K	
 Screw M4×2	 Screw M4×1⅔	 Connecting piece	
6	6	4	

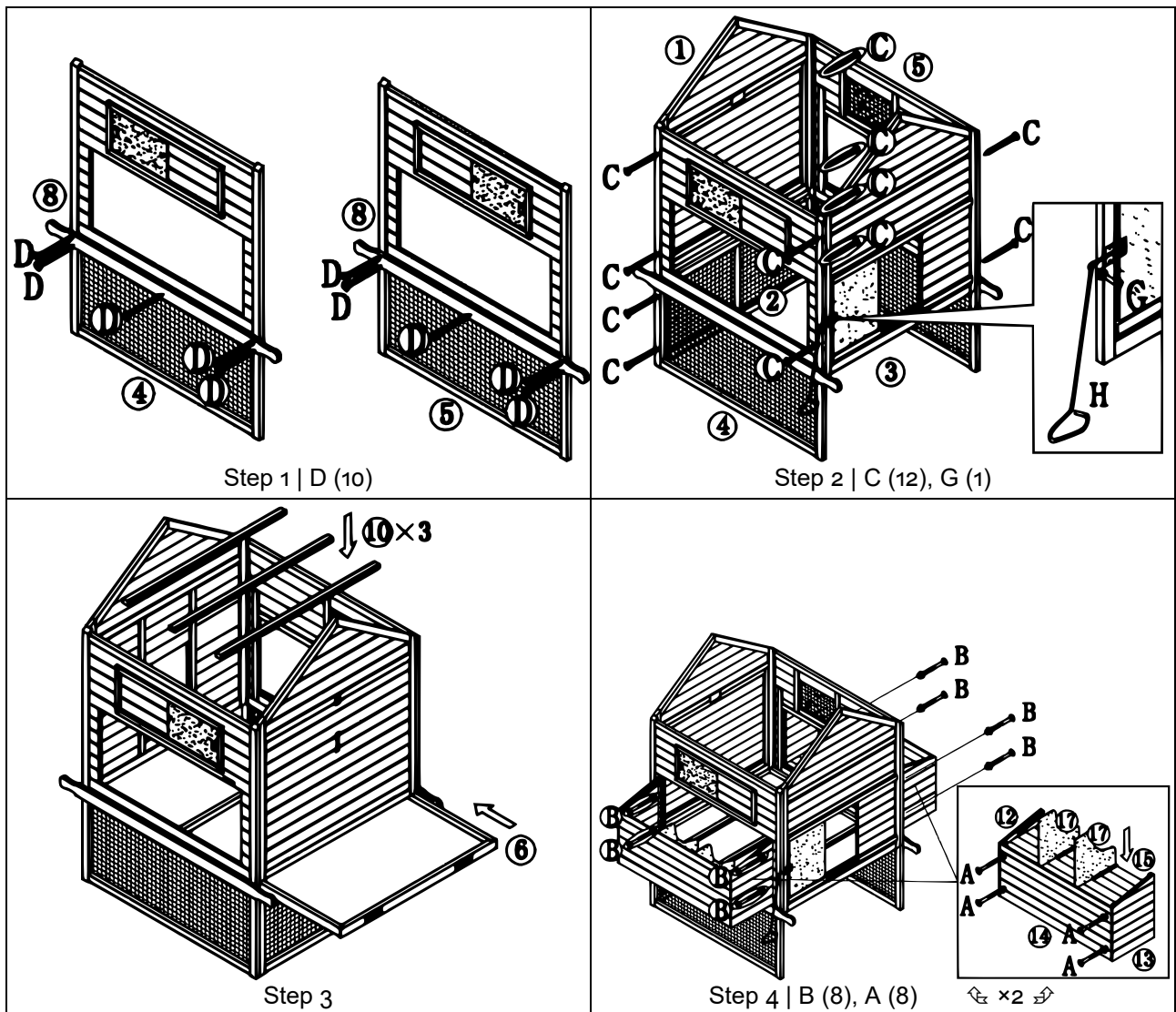

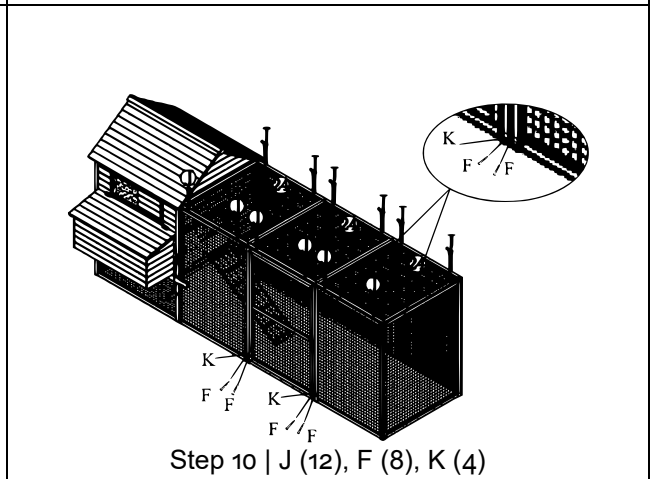
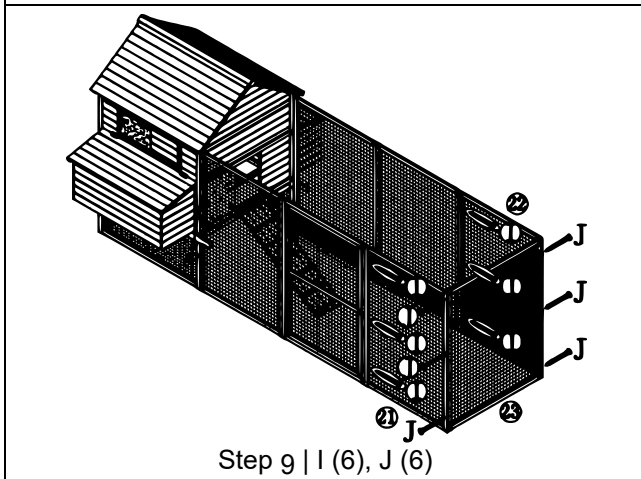
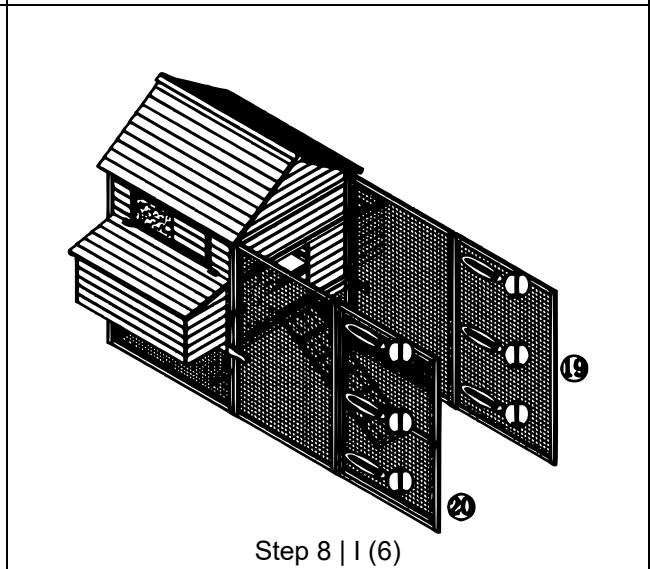
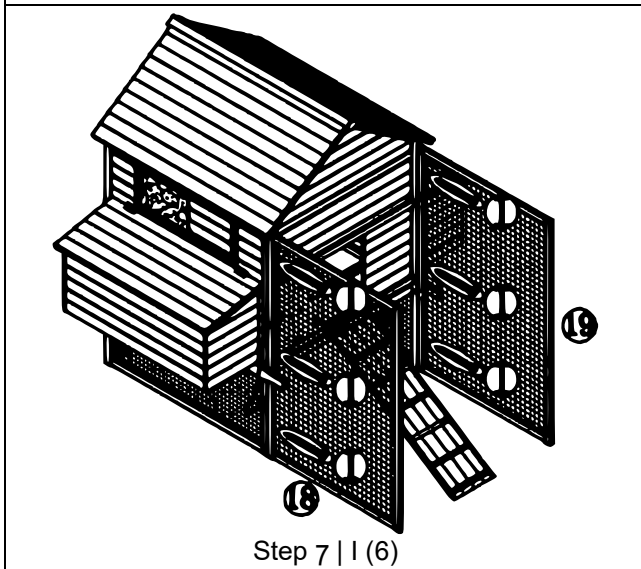
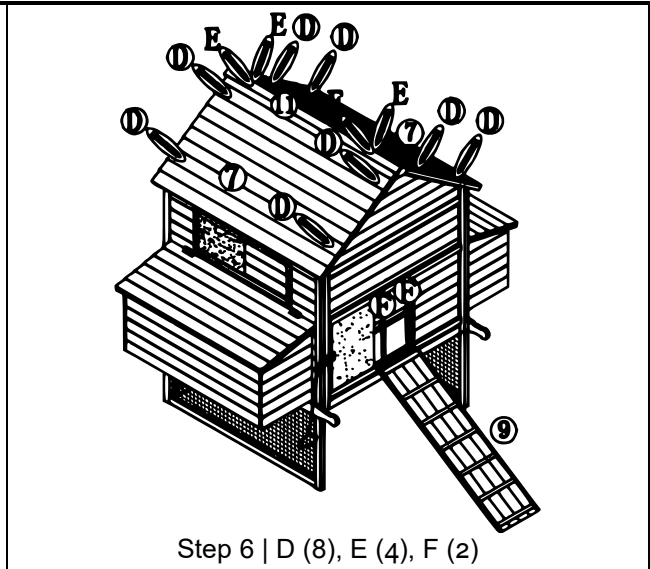
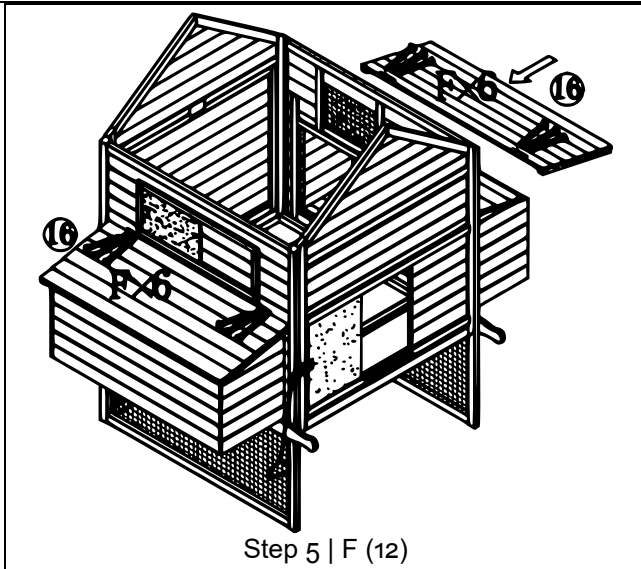

Assembly instructions

⚠ Attention: Before assembling, make sure that you have received 3 packages! Do not use power tools for assembly!



Step 1

Attach the two nesting box supporting rods **(8)** to the left house panel **(4)** and right house panel **(5)** respectively, using 5 screws **(D)** each, total 10 screws.

Step 2

Connect front house panel **(3)**, back house panel **(1)**, back run **(2)**, and the two parts that you have finished in step 1 together, using 12 screws **(C)**. Then attach the metal pull arm **(H)** to front house panel **(3)** using 1 bolt **(G)**.

Step 3

Insert the metal tray **(6)** into the house, then put down 3 perches **(10)** above the metal tray **(6)**.

Step 4

Assemble the nesting box front panel **(14)** and nesting box side panels **(12, 13)** together using 4 bolts **(A)**. Put down the nesting box bottom panel **(15)**, then insert two dividers **(17)** into the nesting box to create 3 nesting areas. The assembly steps for the left and right nesting box are the same. After finishing two nesting boxes, assemble them to main house, using total 8 pcs bolt **(B)**.

Step 5

Assemble the two nesting box roofs **(16)** using 6 screws **(F)** respectively, total 12 screws.

Step 6

Assemble the two house roofs **(7)** using total 8 screws **(D)**. Then attach the ridge **(11)** to the roofs using 4 screws **(E)**. Assemble the ramp **(9)** to the front house panel **(3)** using 2 screws **(F)**.

Step 7

Now attach the left run panel **(18)** and right run panel **(19)** to the main house using 6 screws **(I)**.

Step 8

Attach the left run panel **(20)** to panel **(18)** and attach another right run panel **(19)** to panel **(19)** that you have assembled, using 6 screws **(I)**. Take note that the left run panel **(20)** is the one that is operable and needs to be in the middle of left side.

Step 9

Assemble the left run panel **(21)** and right run panel **(22)** using 6 screws **(I)**; assemble the front run panel **(23)** with panels **(21)** and **(22)** using 6 screws **(J)**.

Step 10

Assemble the 3 upper run panels **(24)** using 12 screws **(J)**. Finally, fix 4 connectors **(K)** to strengthen the run panels, 2 connectors for the left and right side each, using total 8 screws **(F)**. Then the whole assembly is finished.

We wish your hens a pleasant stay!

Important Note:

Reproduction and any commercial use (of parts) of this operating manual, requires a written permission of WilTec Wildanger Technik GmbH.