

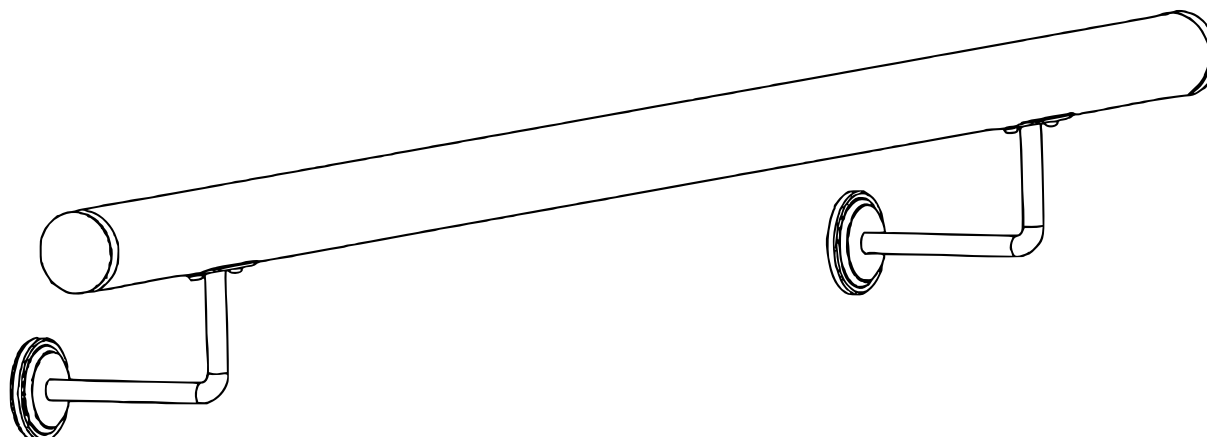

60068–60083, 60771–60818 – Handlijststel

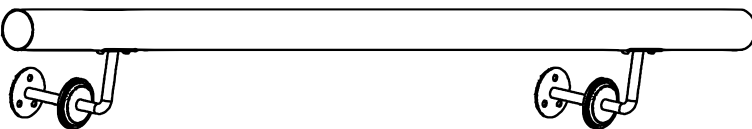

Letter	Betekening	Aant.	Afbeelding
A	Handlijst	1	
B	Afdekkap	2	
C	Betonplug	6	

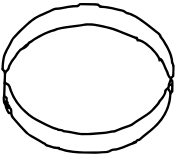
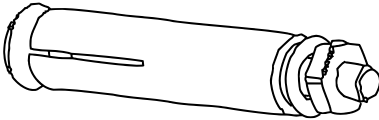
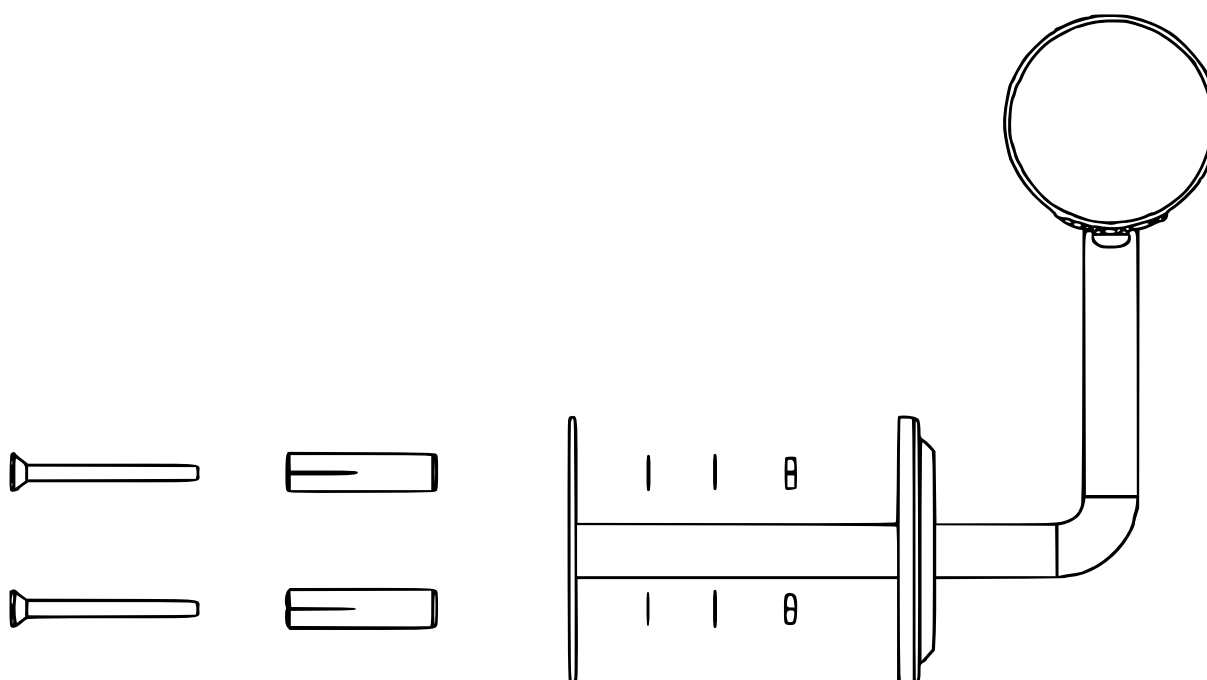

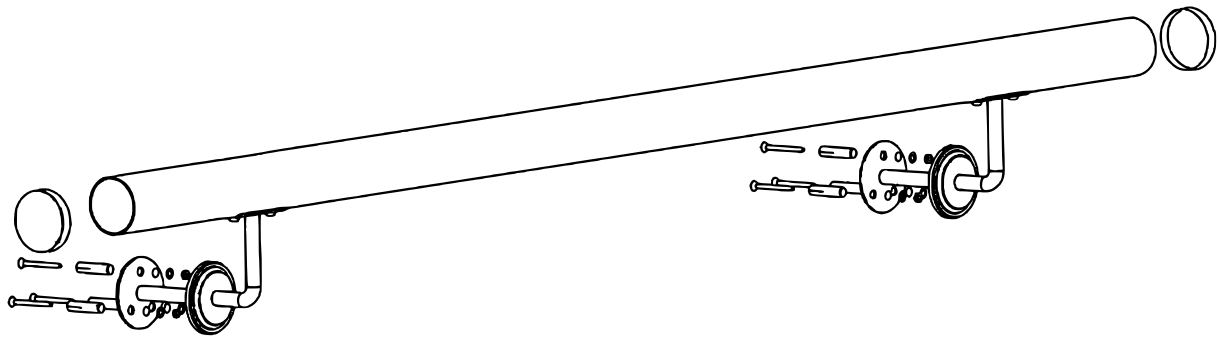
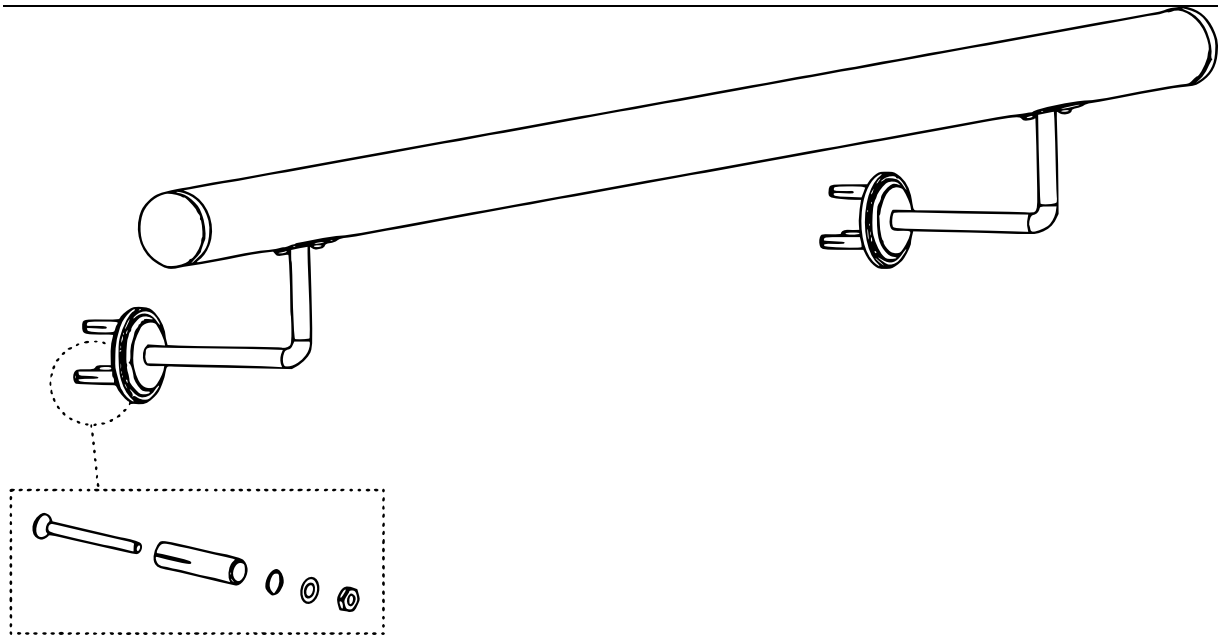

Belangrijk:

Het op welke manier dan ook kopiëren van deze handleiding en/of gebruik ervan voor commerciële doeleinden, is uitsluitend toegestaan met vooraf verkregen schriftelijke toestemming van *WilTec Wildanger Technik GmbH*.