













60120–60123 – Balcony railing

Letter	Name	Figure	Quantity depending on dimensions (cm)				
			100×90	128×90	156×90	184×90	225×90
A	Hand rail		1	1	1	1	1
B	Bottom bar		1	1	1	1	1
C	Screwing bar		2	2	2	4	4
D	Pipe		5	7	10	10	12
E	Wrench		1	1	1	1	1
F	Pedestal		4	4	4	4	4
G	Pedestal cover		4	4	4	4	4
H	Expansion screw		12	12	12	12	12
I	Screw		6	6	6	8	8
J	Pen		1	1	1	1	1
K	Assembly instructions		1	1	1	1	1

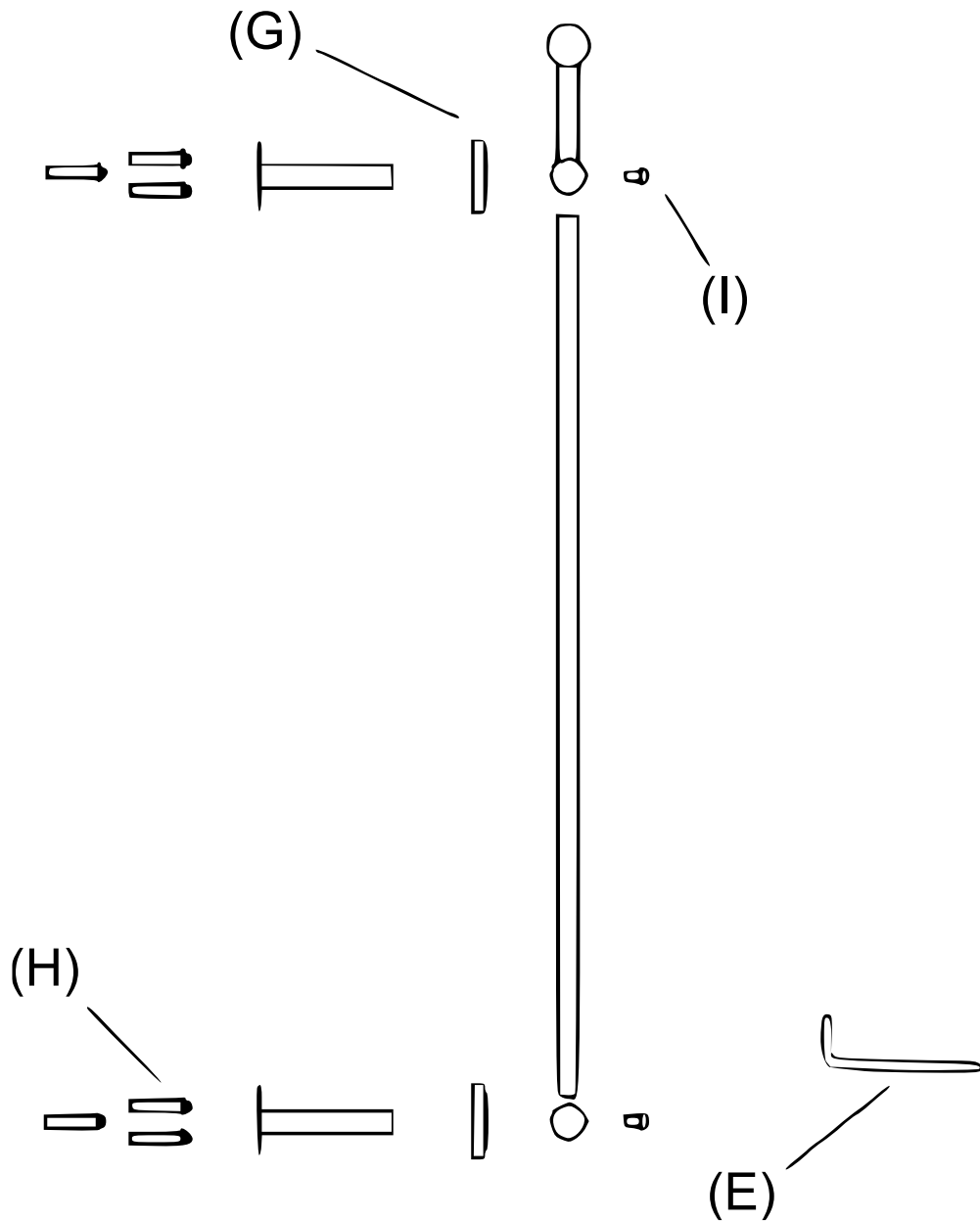

Letter	Name	Letter	Name
E	Wrench (use for screwing)	H	Expansion screw
G	Pedestal cover	I	Screw

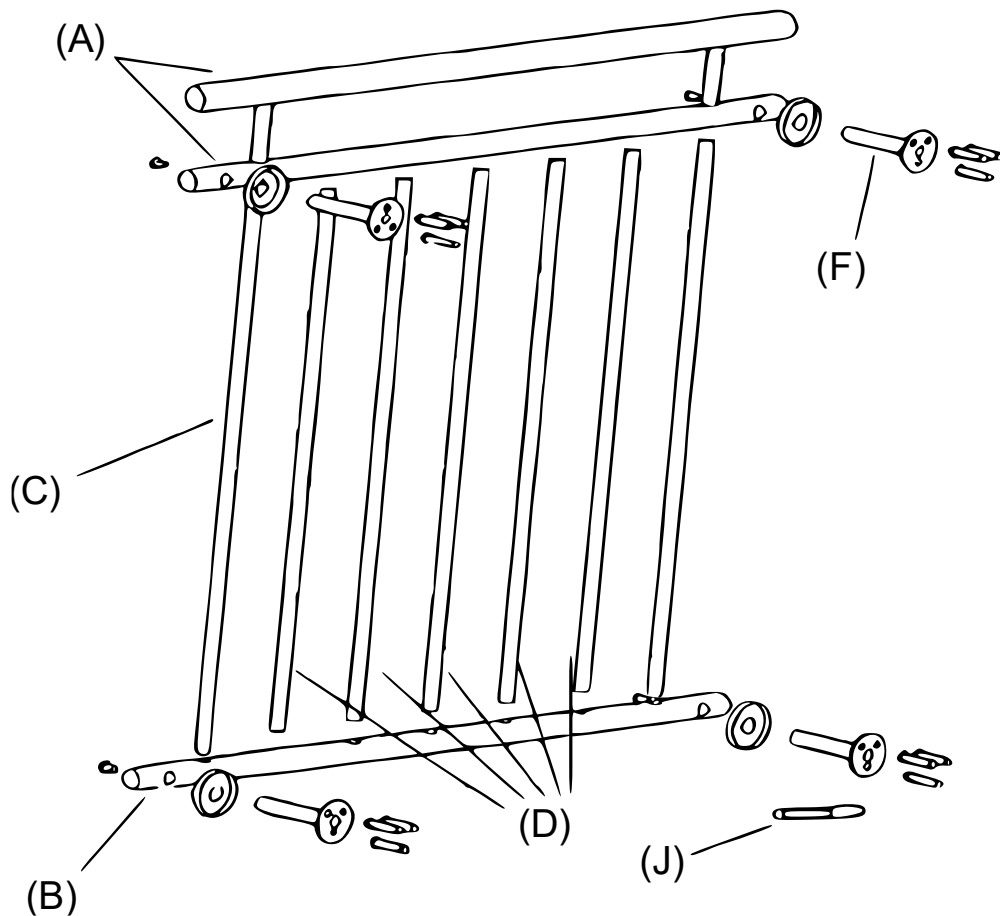

Letter	Name	Letter	Name
A	Hand rail	D	Pipe
B	Bottom bar	F	Foot
C	Screwing bar	J	Pen (use for locating the holes to the wall)

Dimensions

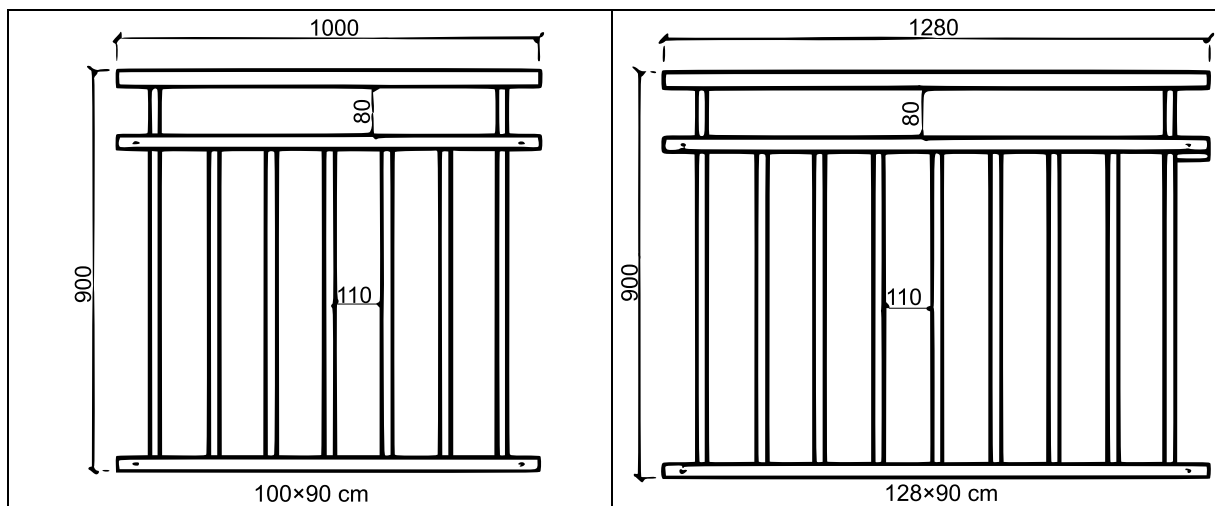

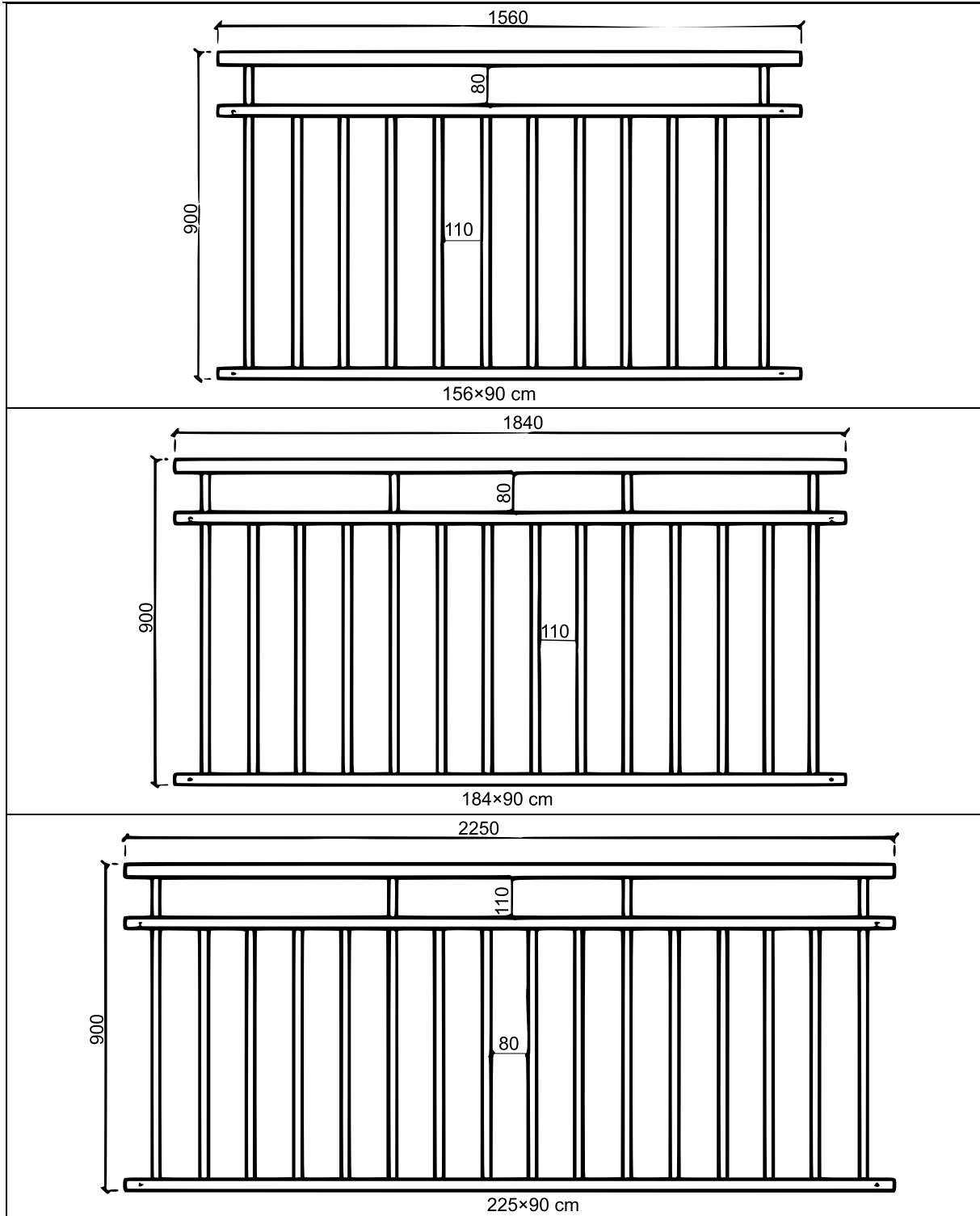

Important Note:

Reproduction and any commercial use (of parts) of this operating manual, requires a written permission of WilTec Wildanger Technik GmbH.