











## 60120–60123 – Barandilla de balcón

Letra	Denominación	Figura	Unidades en función de las dimensiones (cm)				
			100×90	128×90	156×90	184×90	225×90
A	Pasamanos		1	1	1	1	1
B	Barra inferior		1	1	1	1	1
C	Barra atornillable		2	2	2	4	4
D	Barra		5	7	10	10	12
E	Llave		1	1	1	1	1
F	Base		4	4	4	4	4
G	Anillo de recubierta de la base		4	4	4	4	4
H	Tornillo tensional		12	12	12	12	12
I	Tornillo		6	6	6	8	8
J	Bolígrafo		1	1	1	1	1
K	Manual de ensamble		1	1	1	1	1



Letra	Denominación	Letra	Denominación
<b>E</b>	Llave (para atornillar)	<b>H</b>	Tornillo tensional
<b>G</b>	Anillo de recubierta de la base	<b>I</b>	Tornillo

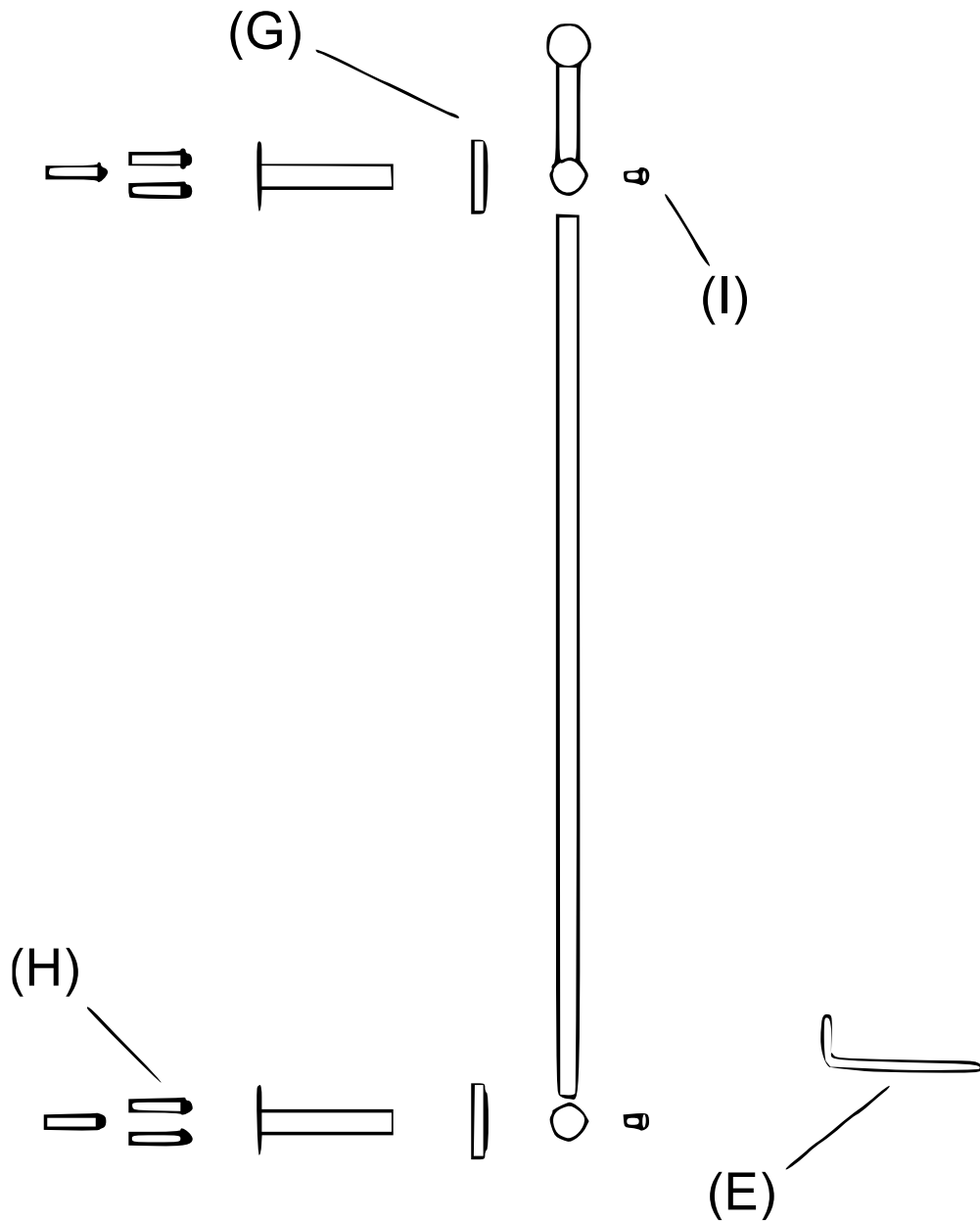
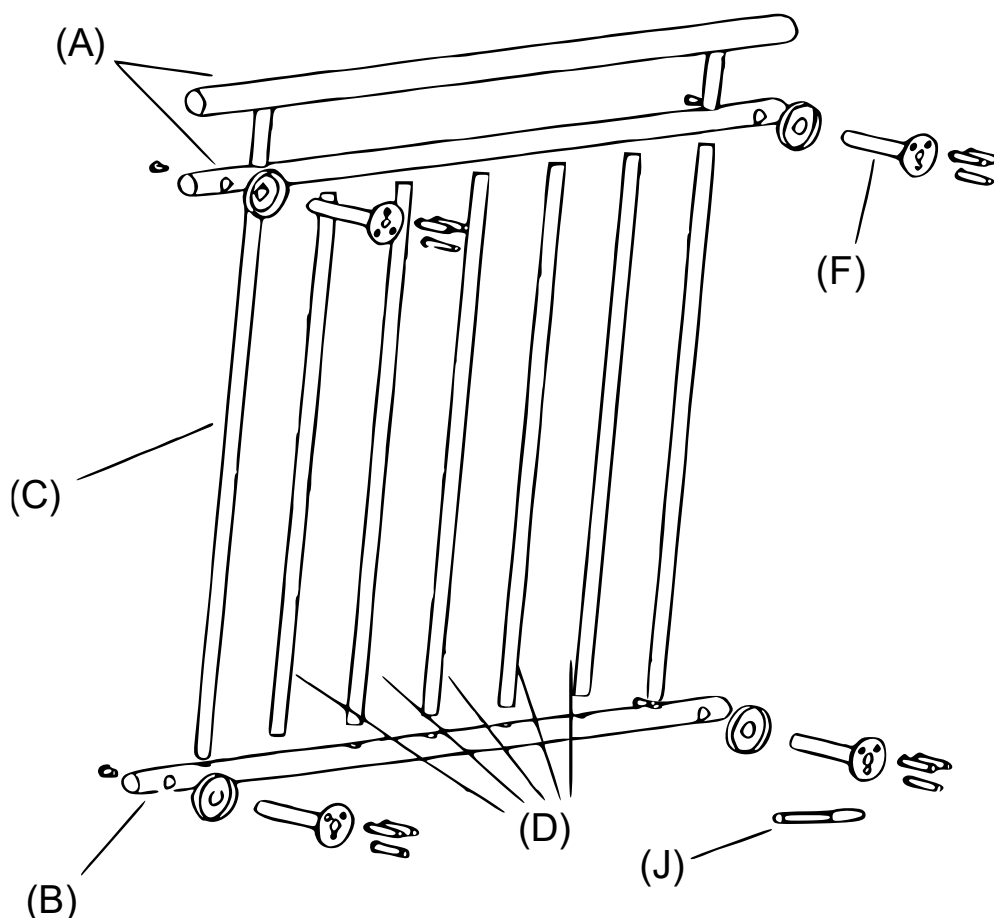

Letra	Denominación	Letra	Denominación
A	Pasamanos	D	Barra
B	Barra inferior	F	Base
C	Barra atornillable	J	Bolígrafo (para marcar los agujeros en la pared)

## Dimensiones

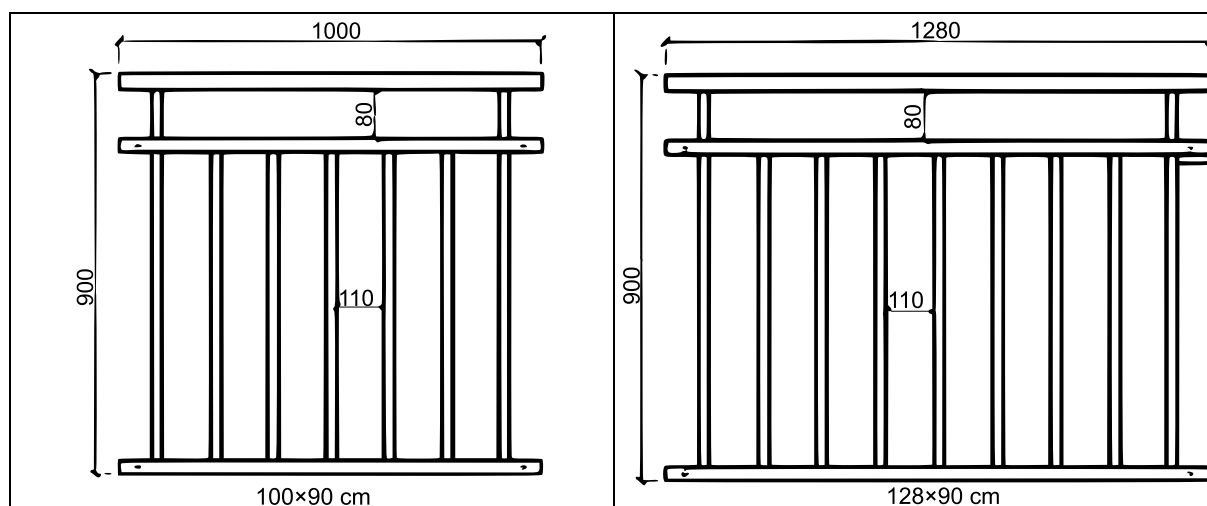

# ENSAMBLAJE

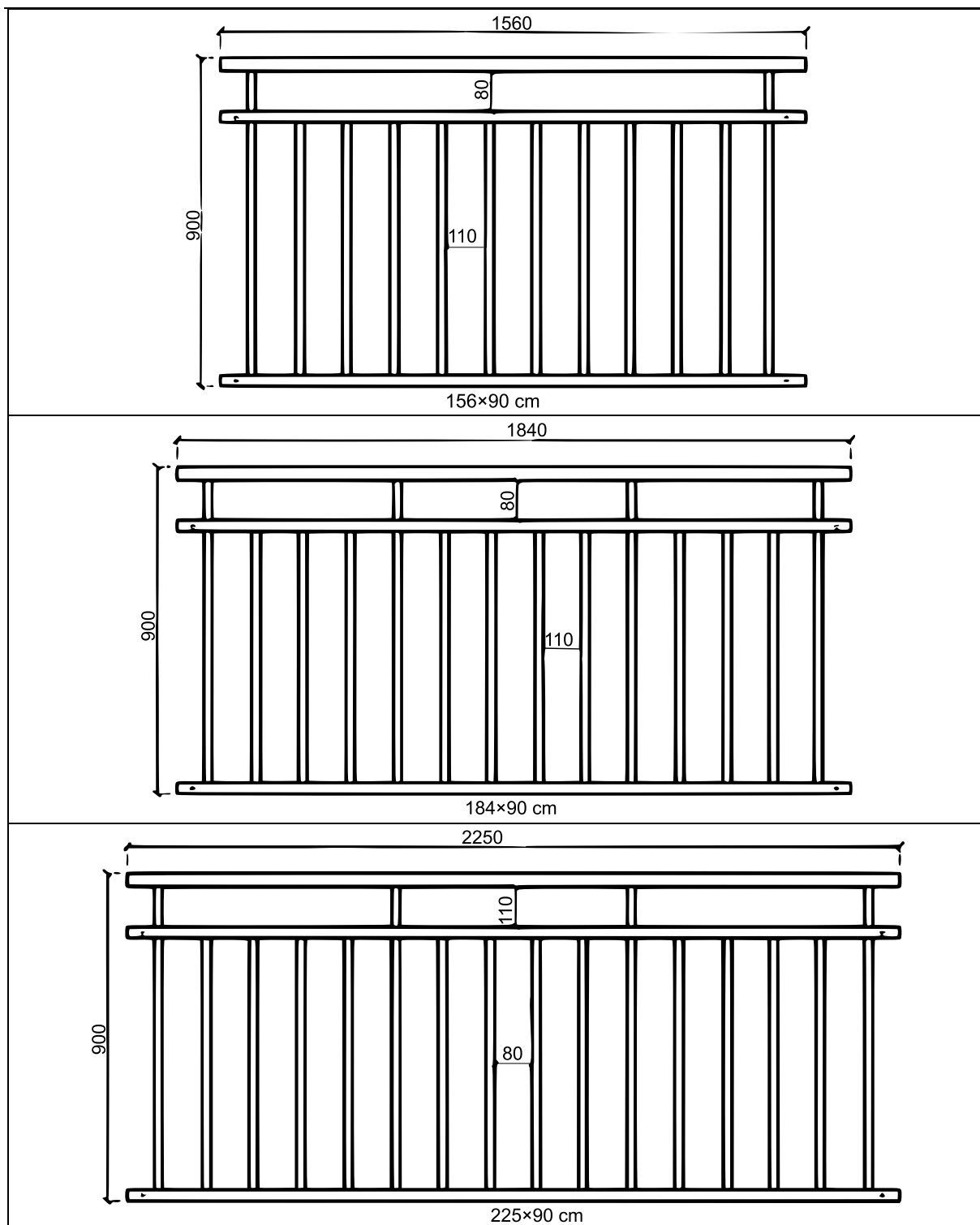

## AVISO IMPORTANTE:

La reproducción total o parcial, así como cualquier uso comercial que se le pudiera dar a este manual, al todo o alguna de sus partes, solo mediante autorización escrita por parte de la empresa WilTec Wildanger Technik GmbH.