











60120–60123 – Balustrade de balcon

Lettre	Dénomina- tion	Figure	Quantité en fonction des dimensions (cm)				
			100×90	128×90	156×90	184×90	225×90
A	Main cou- rante		1	1	1	1	1
B	Barre infé- rieure		1	1	1	1	1
C	Tube file- table		2	2	2	4	4
D	Tube		5	7	10	10	12
E	Clé		1	1	1	1	1
F	Pied		4	4	4	4	4
G	Anneau cou- vrant		4	4	4	4	4
H	Vis de trac- tion		12	12	12	12	12
I	Vis		6	6	6	8	8
J	Stylo		1	1	1	1	1
K	Instructions de montage		1	1	1	1	1



Lettre	Dénomination	Lettre	Dénomination
E	Clé (pour visser)	H	Vis de traction
G	Anneau couvrant	I	Vis

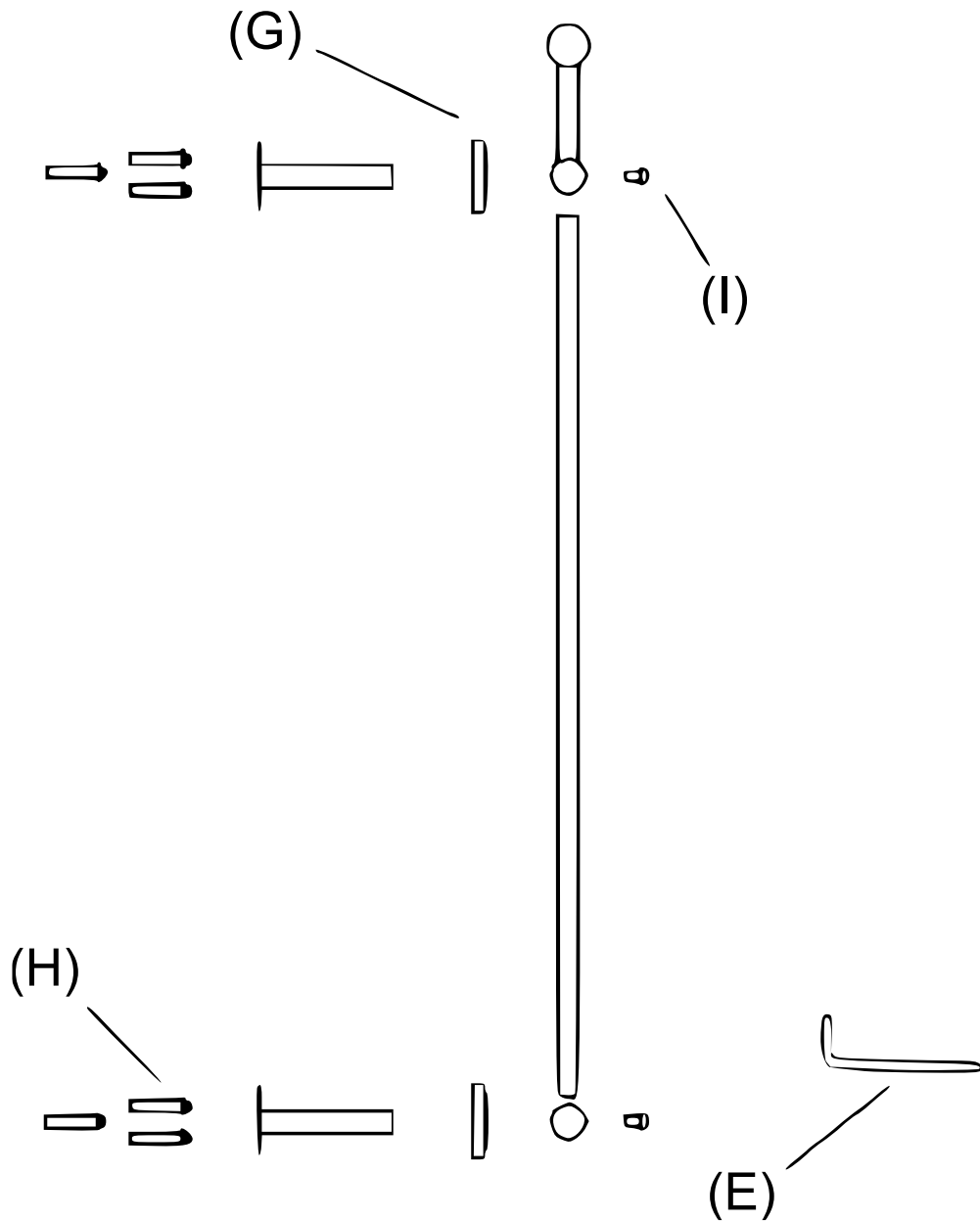
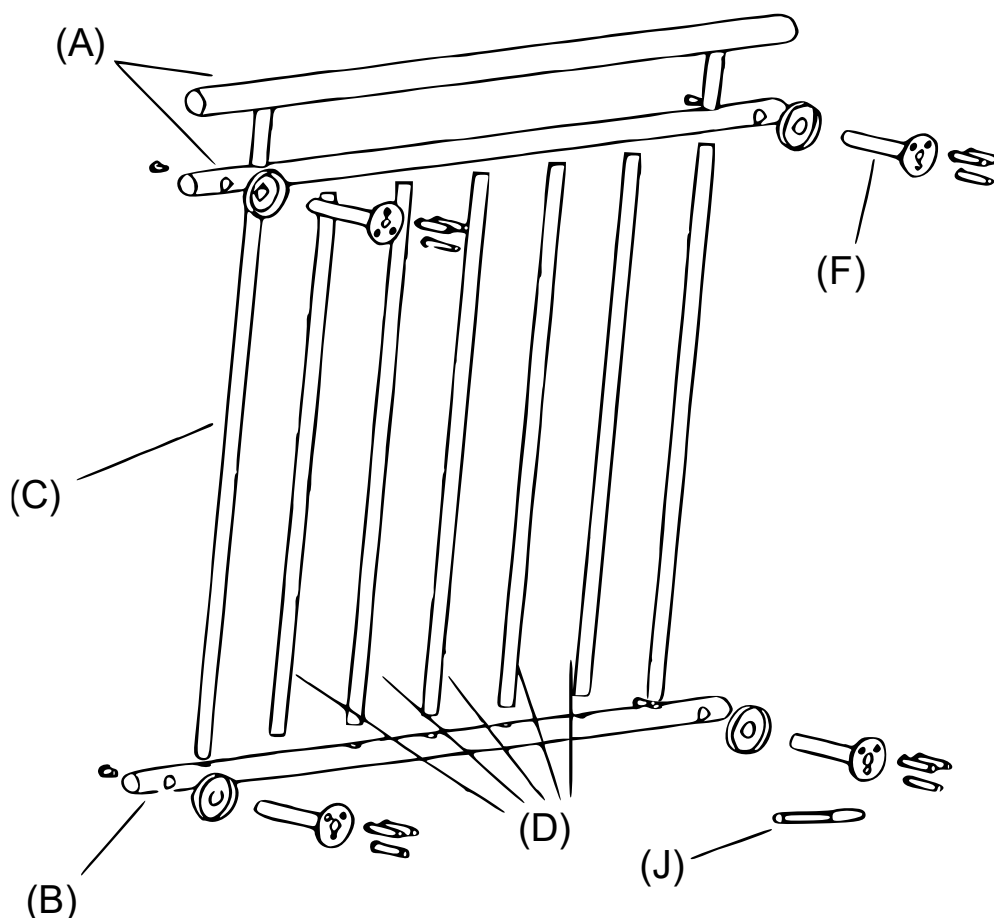

Lettre	Dénomination	Lettre	Dénomination
A	Main courante	D	Tube
B	Barre de base	F	Pied
C	Tube filetable	J	Crayon (pour marquer les trous dans le mur)

Dimensions

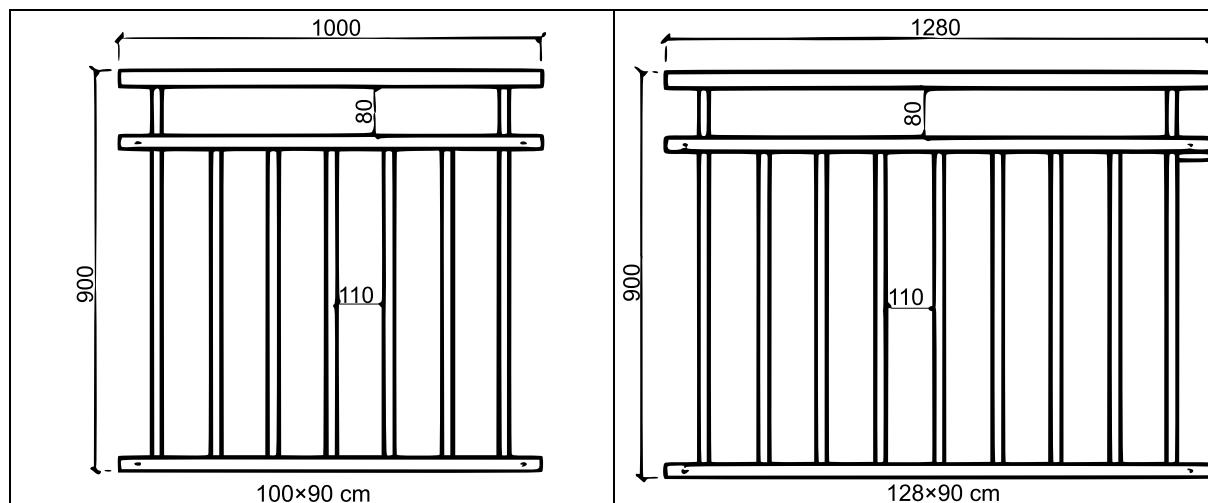

ASSEMBLAGE

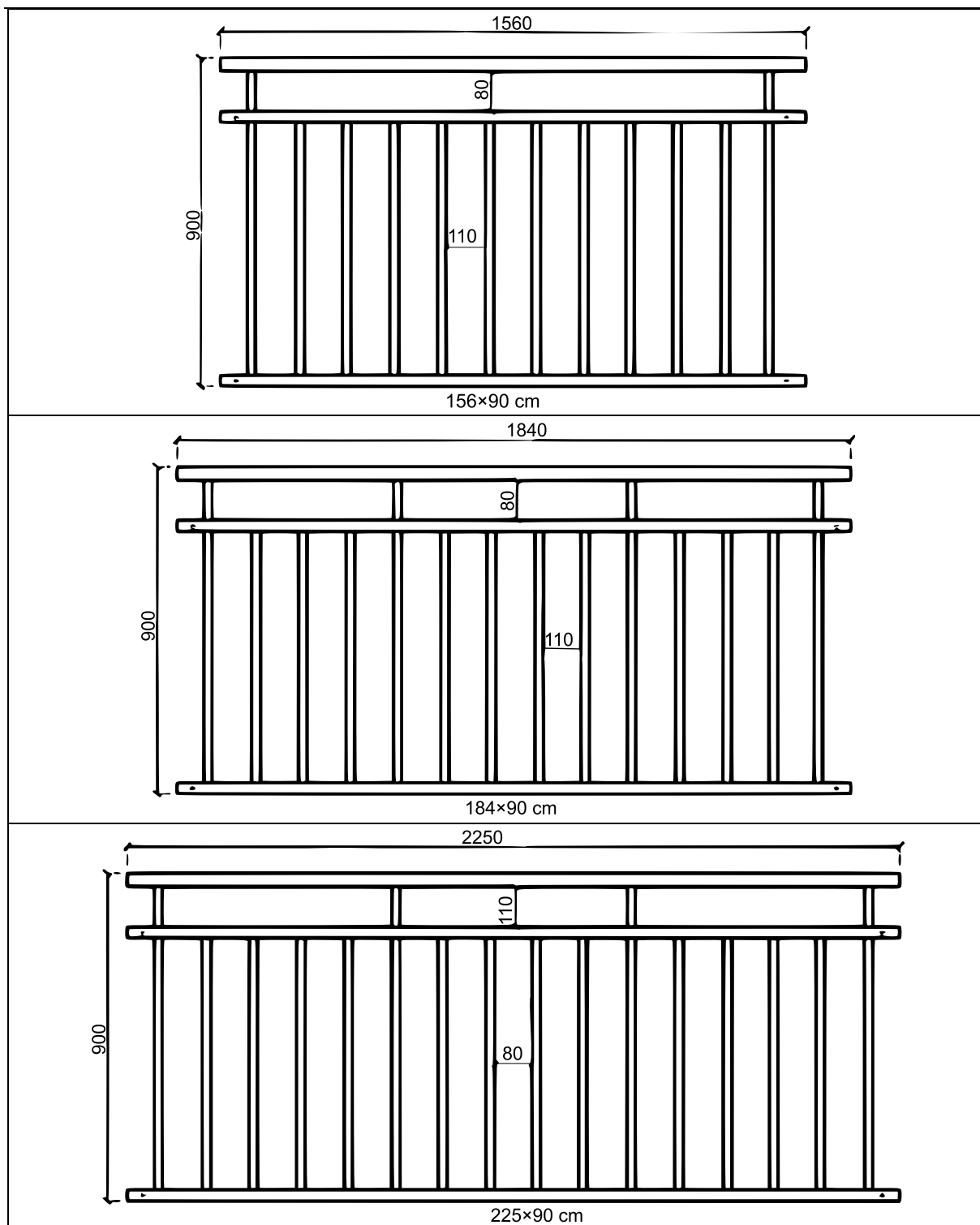

Avis important :

Toute reproduction et toute utilisation à des fins commerciales, même partielle de ce mode d'emploi, ne sont autorisées qu'avec l'accord préalable de la société WilTec Wildanger Technik GmbH.