













60120–60123 – Balkonleuning

Letter	Betekening	Afbeelding	Aantal afhankelijk van afmetingen (cm)				
			100×90	128×90	156×90	184×90	225×90
A	Leuning		1	1	1	1	1
B	Onderste buis		1	1	1	1	1
C	Schroefbuis		2	2	2	4	4
D	Buis		5	7	10	10	12
E	Sleutel		1	1	1	1	1
F	Basis		4	4	4	4	4
G	Basis-afdek-ring		4	4	4	4	4
H	Expansieschroef		12	12	12	12	12
I	Schroef		6	6	6	8	8
J	Pen		1	1	1	1	1
K	Monterings-handleiding		1	1	1	1	1

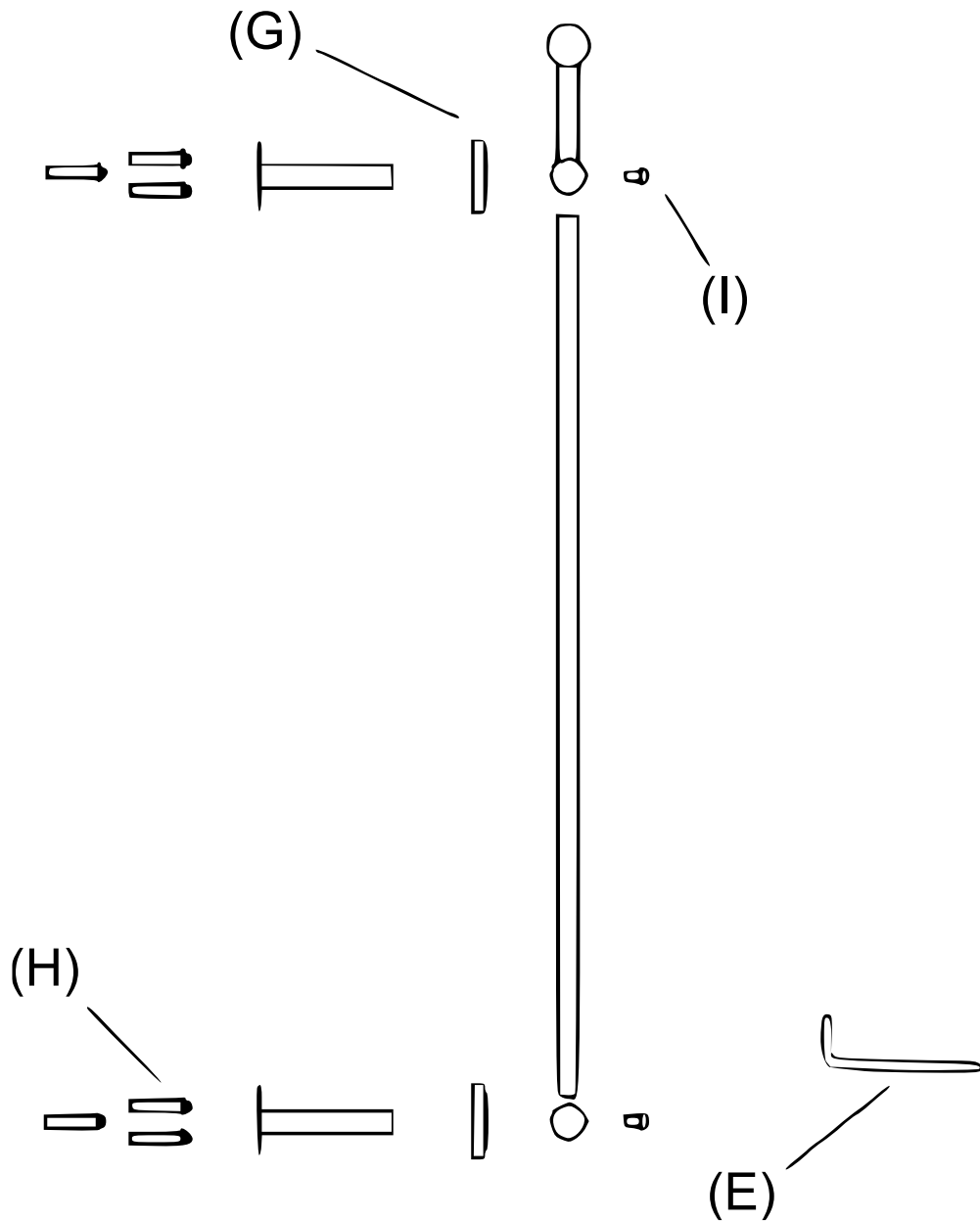

Letter	Betekening	Letter	Betekening
E	Sleutel (hiermee vastschroeven)	H	Expansieschroef
G	Basis-afdekring	I	Schroef

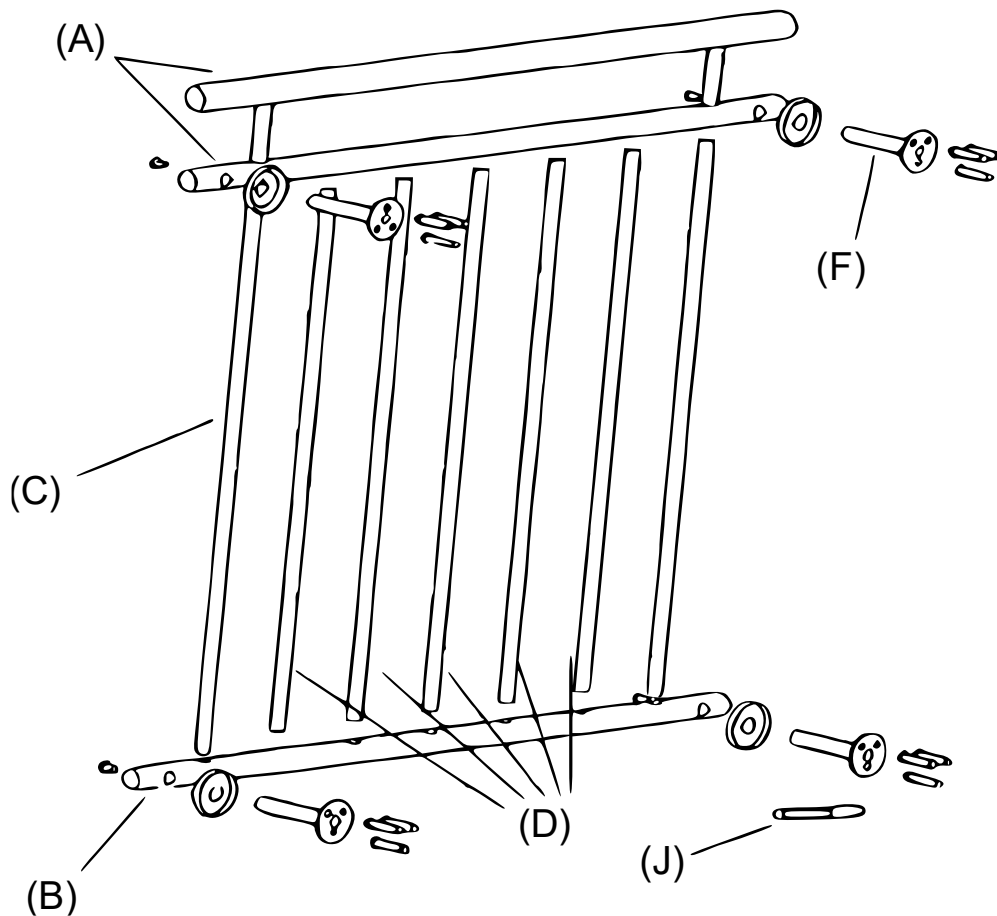

Letter	Betekening	Letter	Betekening
A	Leuning	D	Buis
B	Onderste buis	F	Basis
C	Schroefbuis	J	Pen (hiermee de gaten op de muur markeren)

Afmetingen

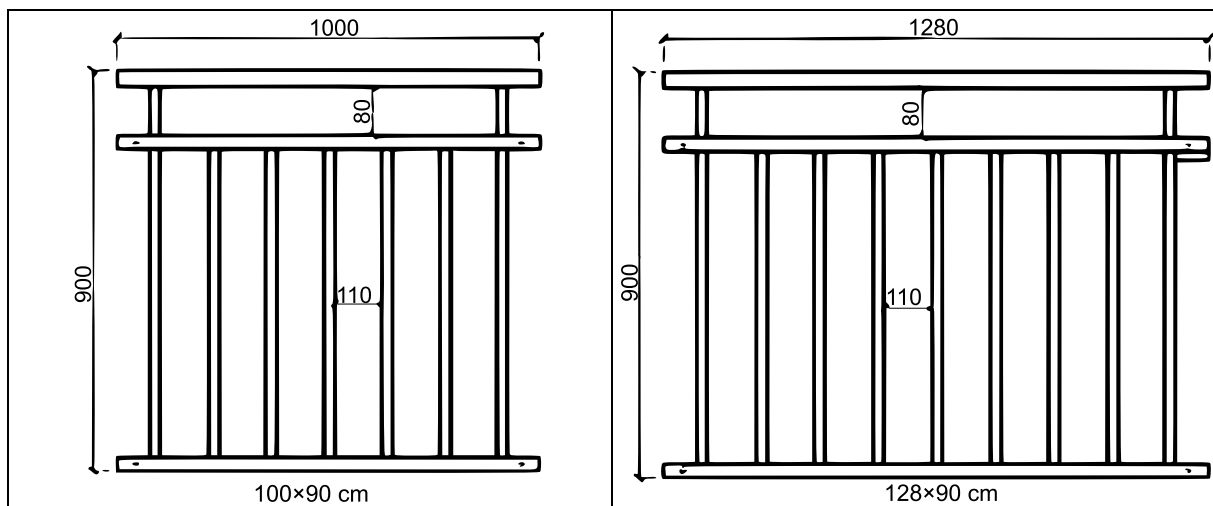

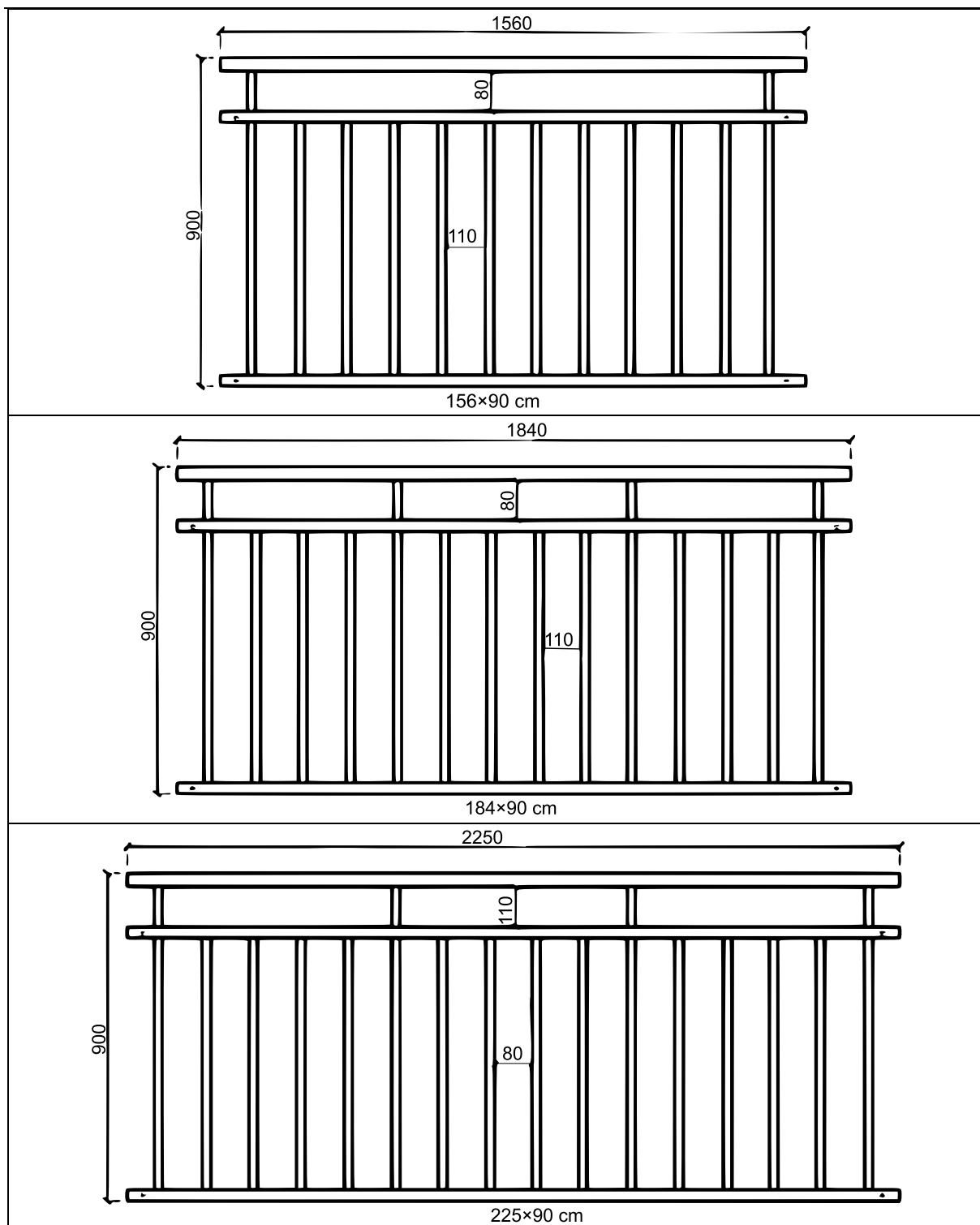

Belangrijk:

Het op welke manier dan ook kopiëren van deze handleiding en/of gebruik ervan voor commerciële doeleinden, is uitsluitend toegestaan met vooraf verkregen schriftelijke toestemming van *WilTec Wildanger Technik GmbH*.