

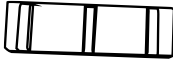















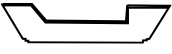

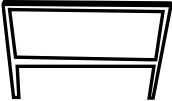
60192 – Rodent Cage

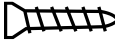
Letter	Name	Fig.	Qty.	Letter	Name	Fig.	Qty.
A	Rear wall part		1	M	Seesaw		2
B	Rear side part		2	N	Seesaw base		2
C	Front side part		2	O	Water cup		1
D	Side floor part		2	P	Lid bar		1
E	Lower shelf		1	Q	Door buckle		1
F	Upper shelf		1	A ₁	Screw (M4×25 mm)		34
G	Front wall part		1	A ₂	Screw (M3×20 mm)		2
H	Front wall part		1	A ₃	Screw (M3×10 mm)		36
I	Middle floor part		1	A ₄	Hinge		5
J	Lid		1	A ₅	Wooden axle		1
K	Ramp		3	A ₆	Knob		1
L	House side part		2				

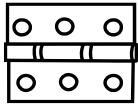
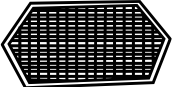

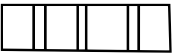

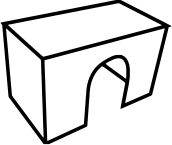
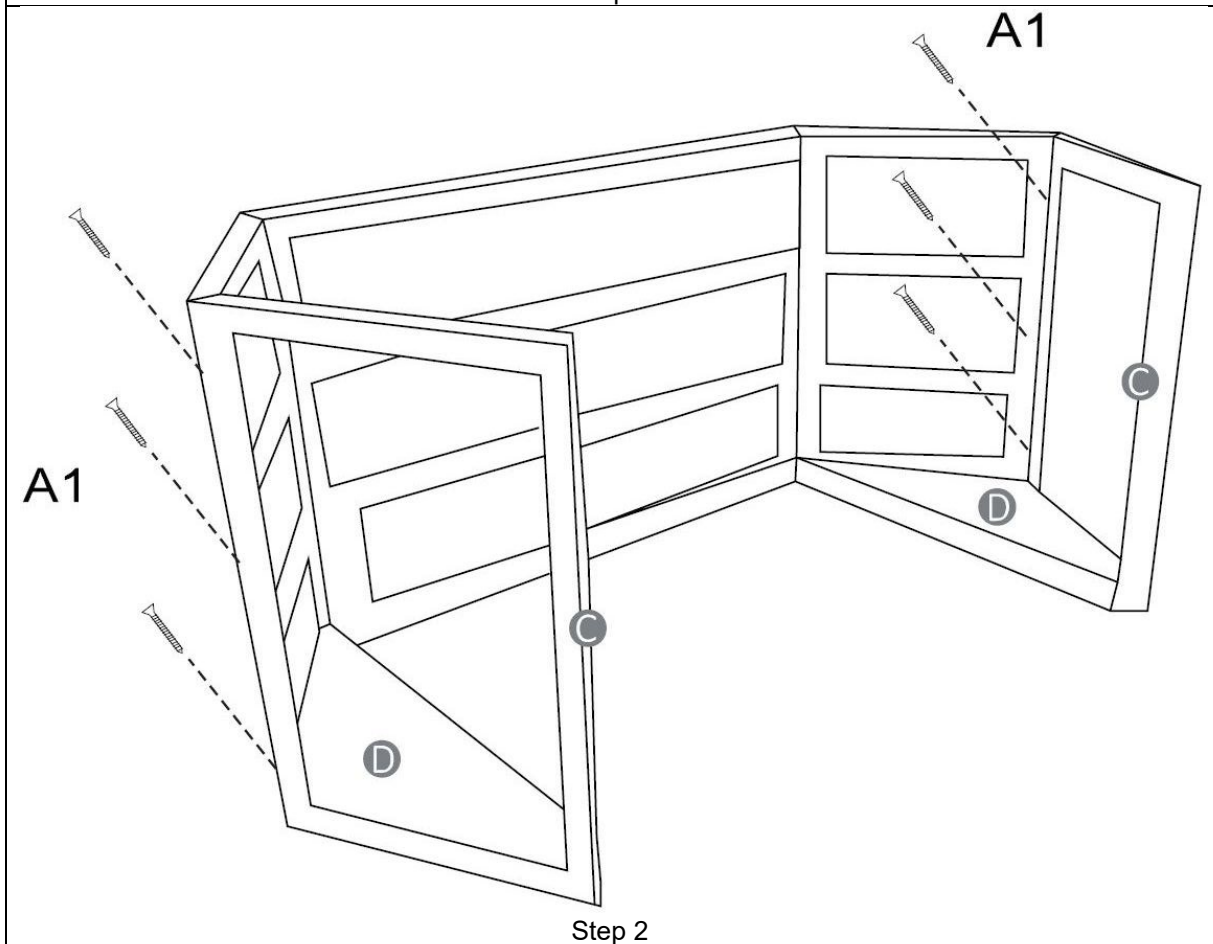
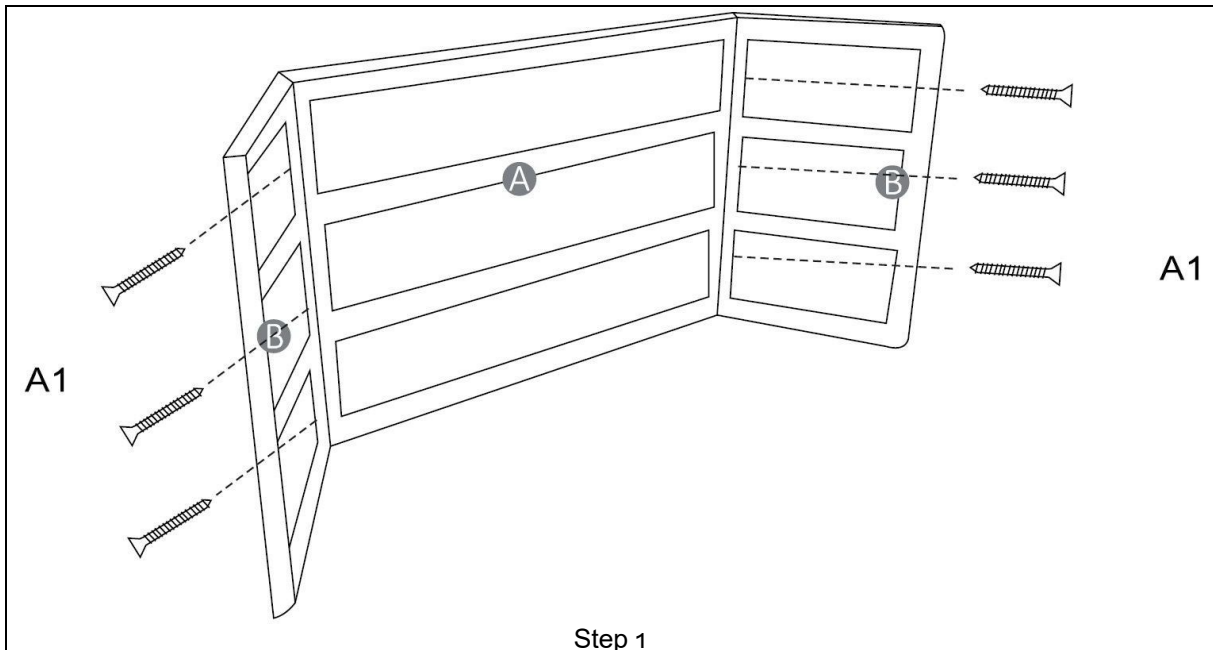
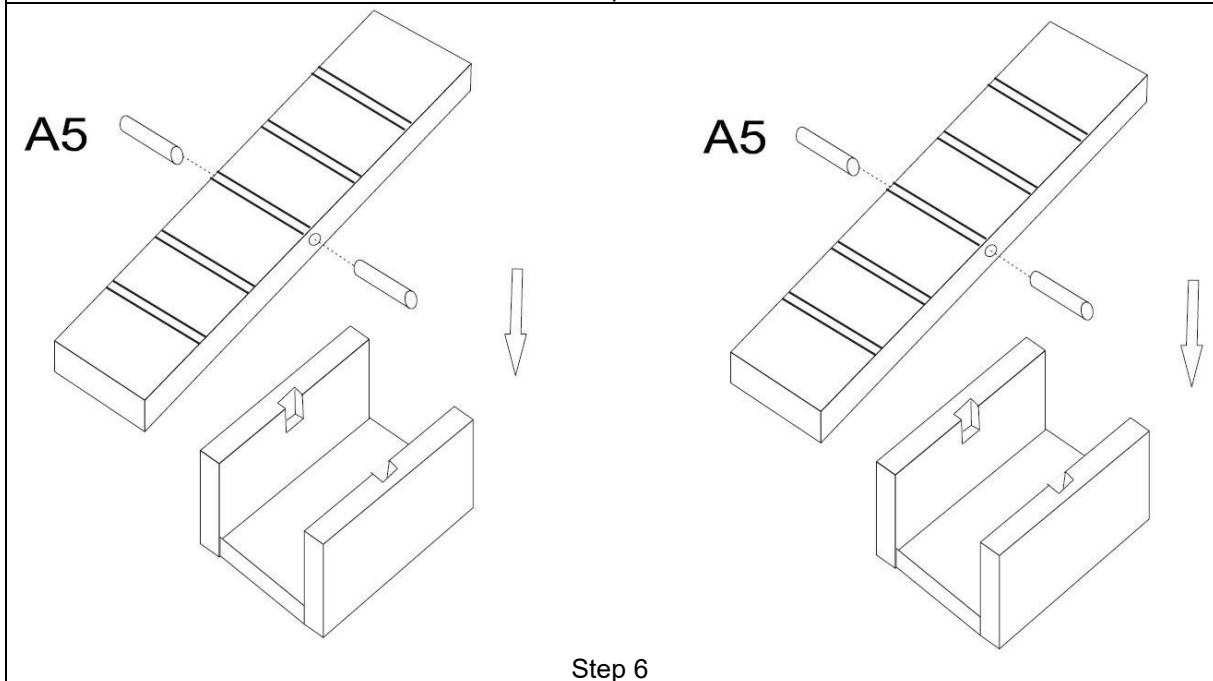
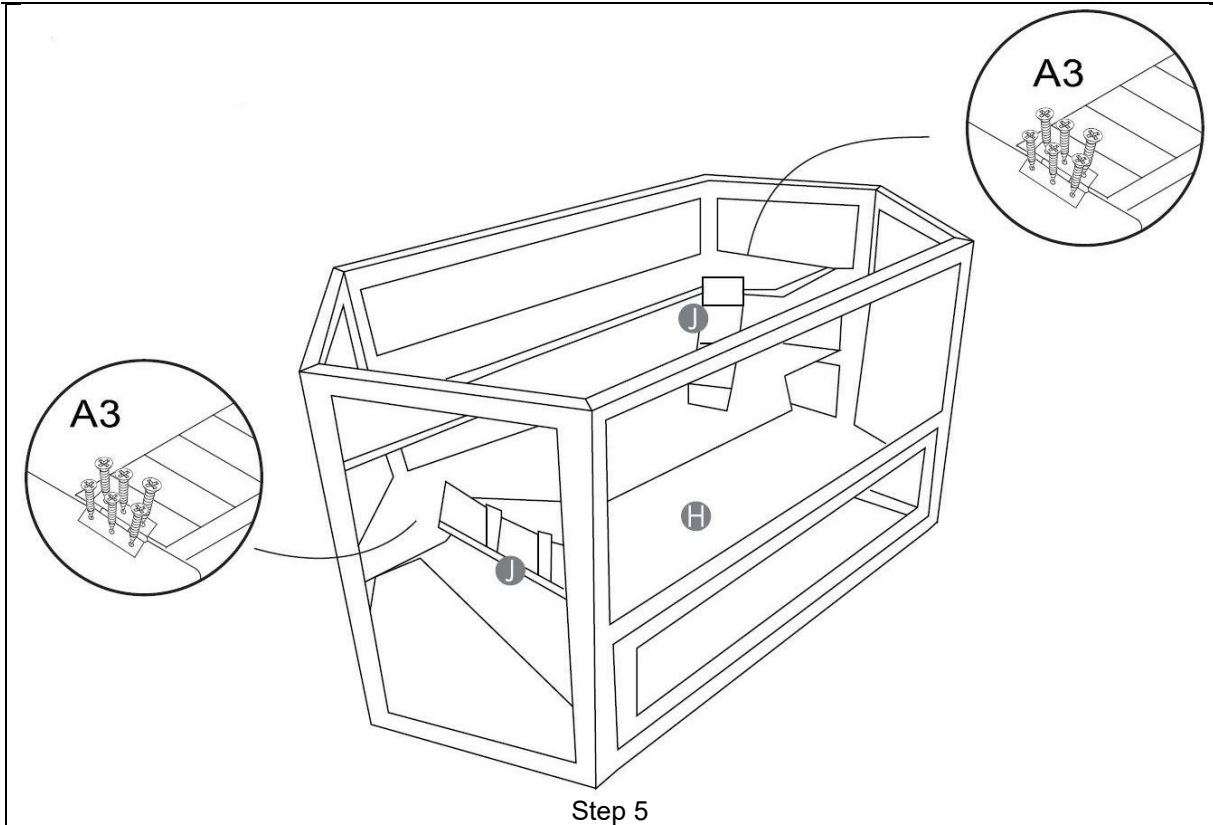
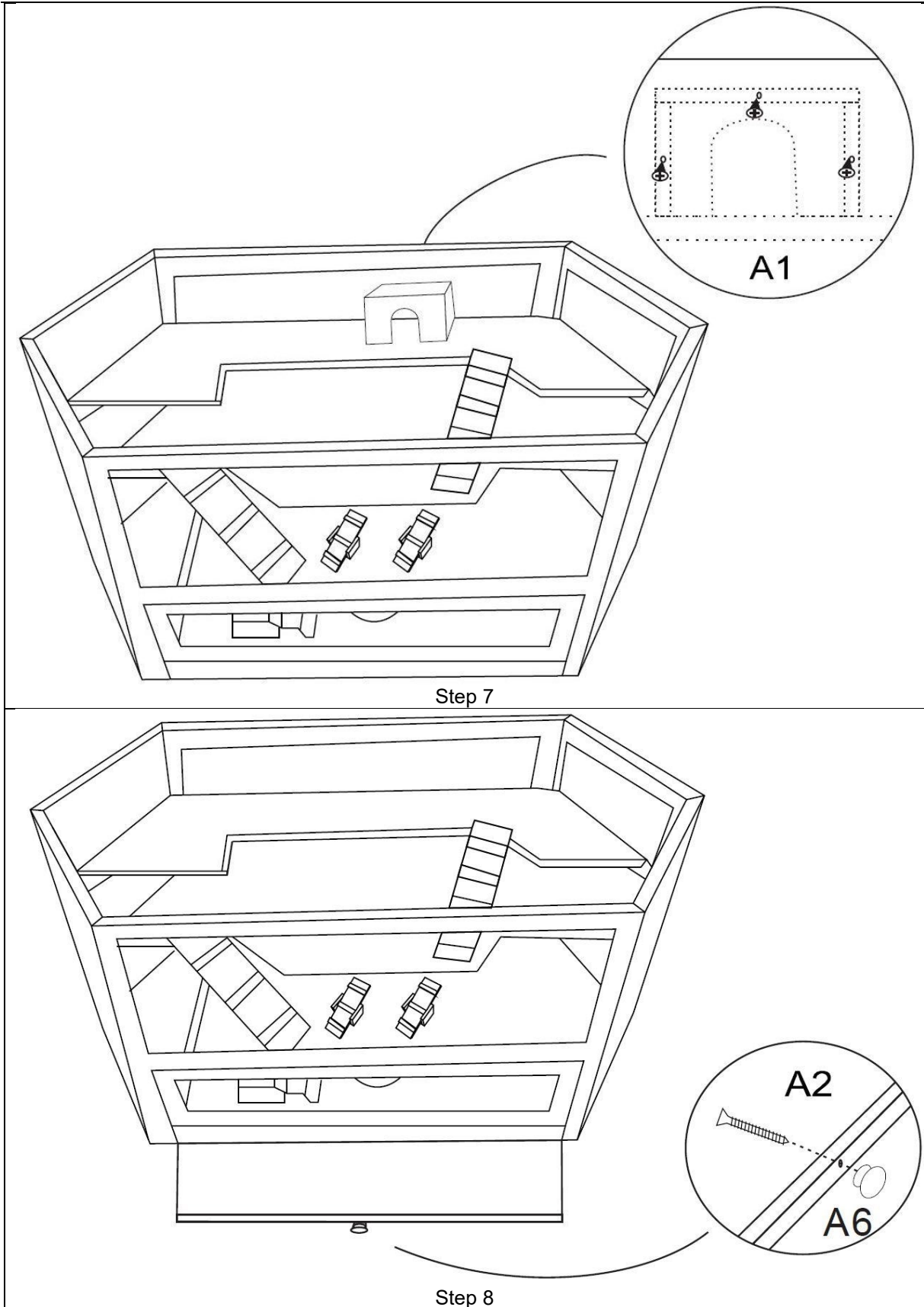

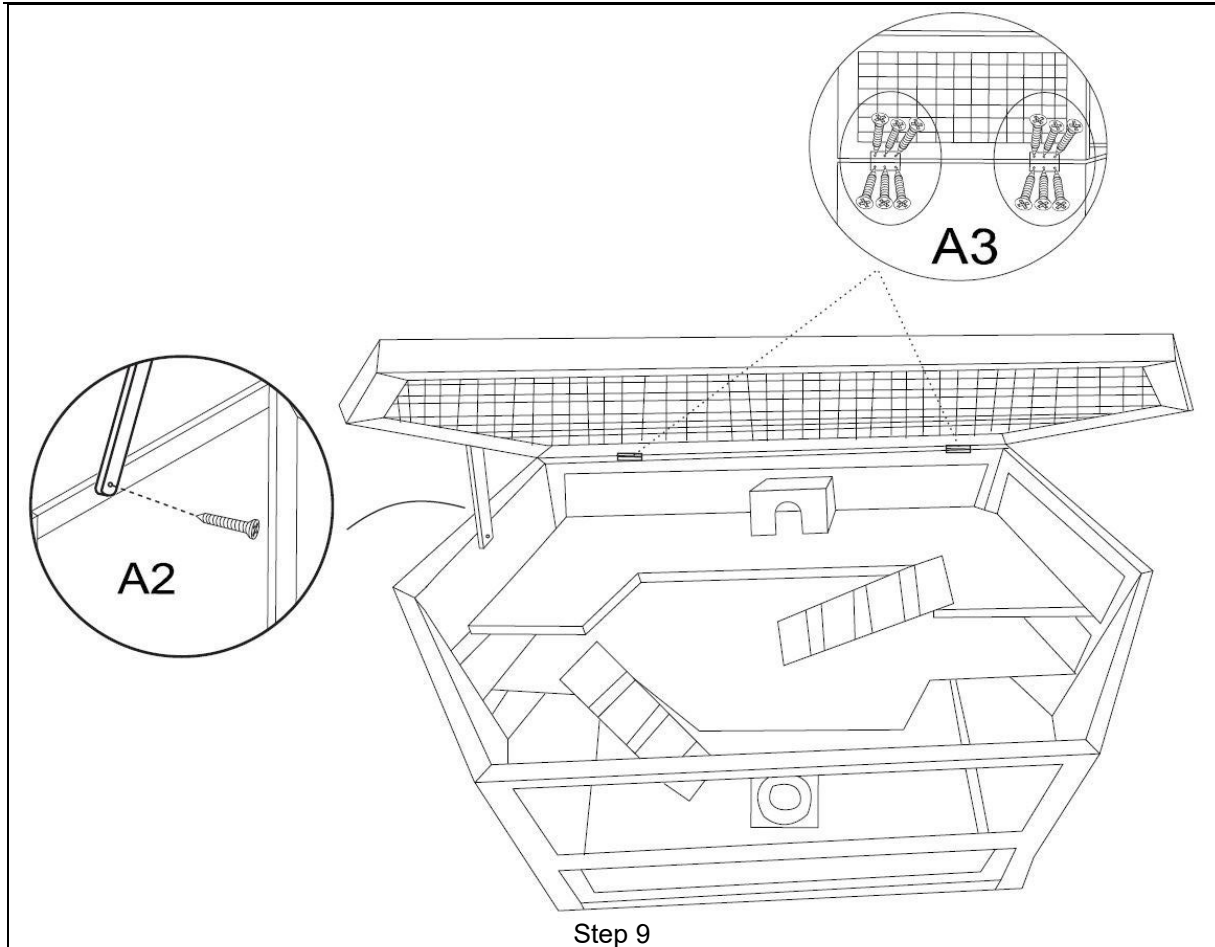

Important note:

The reprint or reproduction, even of excerpts, and any commercial use, even in part of this instruction manual requires the written permission of the WilTec Wildanger Technik GmbH.