

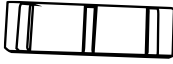













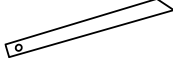

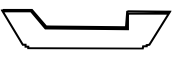
# Manual de montaje

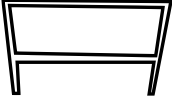
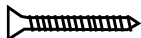
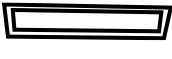
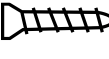
## 60192 – Jaula para hámster

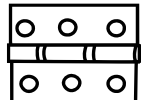
Letra	Nombre	Fig.	Uds.	Letra	Nombre	Fig.	Uds.
A	Panel pared trasero		1	M	Balancín		2
B	Panel lateral trasero		2	N	Base del balancín		2
C	Panel lateral frontal		2	O	Cuenco de agua		1
D	Sección lateral de la base		2	P	Puntal de la tapa		1
E	Balda inferior		1	Q	Tope para puerta		1
F	Balda superior		1	A <sub>1</sub>	Tornillo (M4×25 mm)		34
G	Panel pared frontal		1	A <sub>2</sub>	Tornillo (M3×20 mm)		2
H	Panel pared frontal		1	A <sub>3</sub>	Tornillo (M3×10 mm)		36
I	Sección central de la base		1	A <sub>4</sub>	Bisagra		5
J	Tapa		1	A <sub>5</sub>	Eje de madera		1
K	Rampa		3	A <sub>6</sub>	Pomo		1
L	Panel lateral de la casa		2				

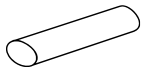

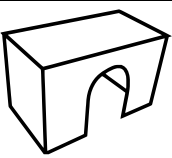
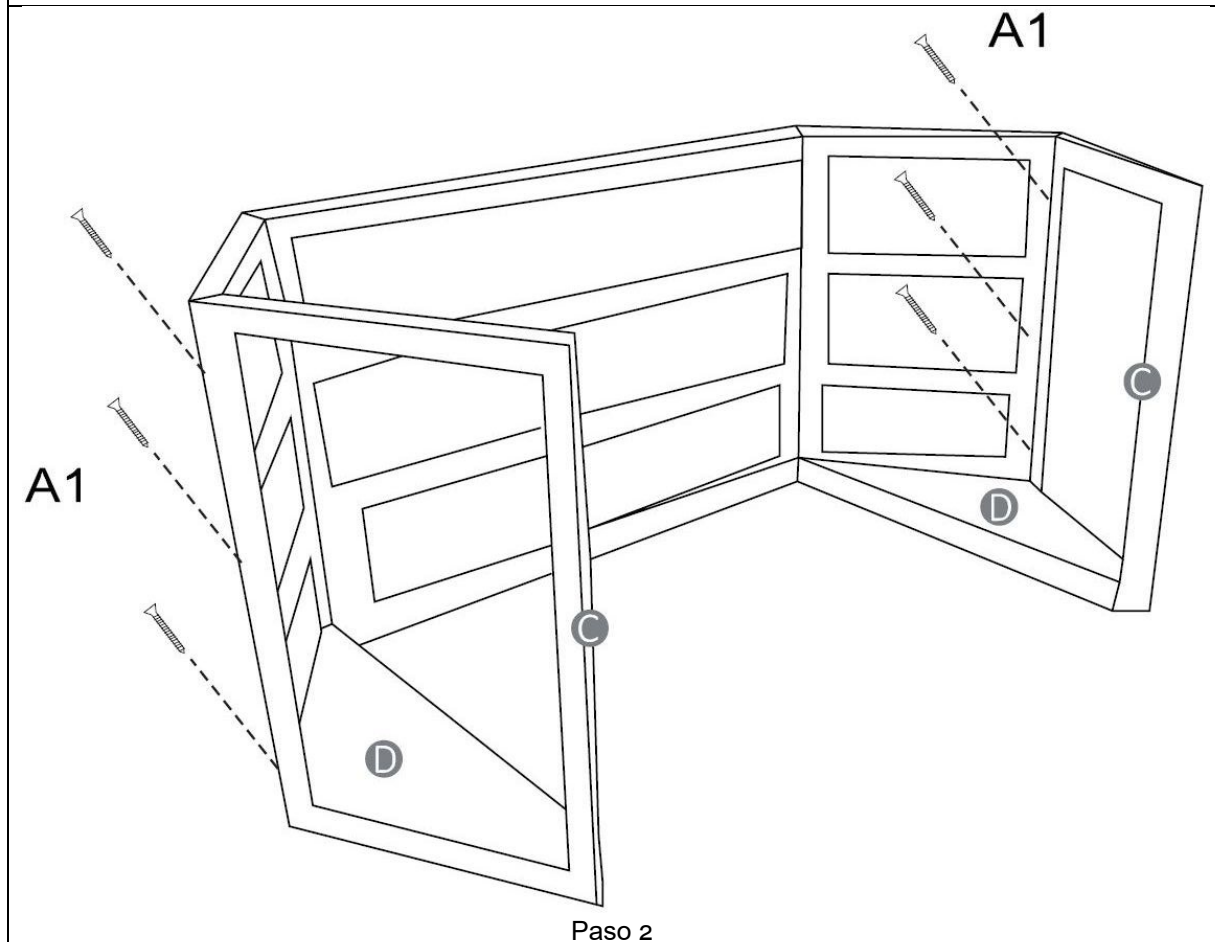
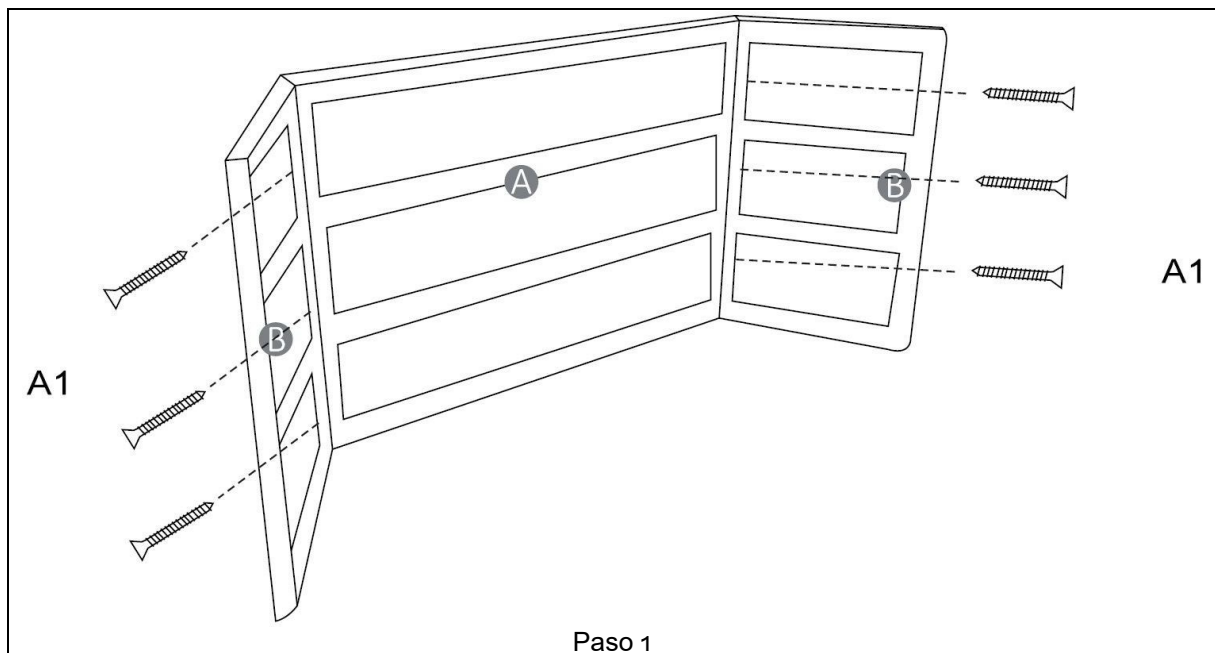

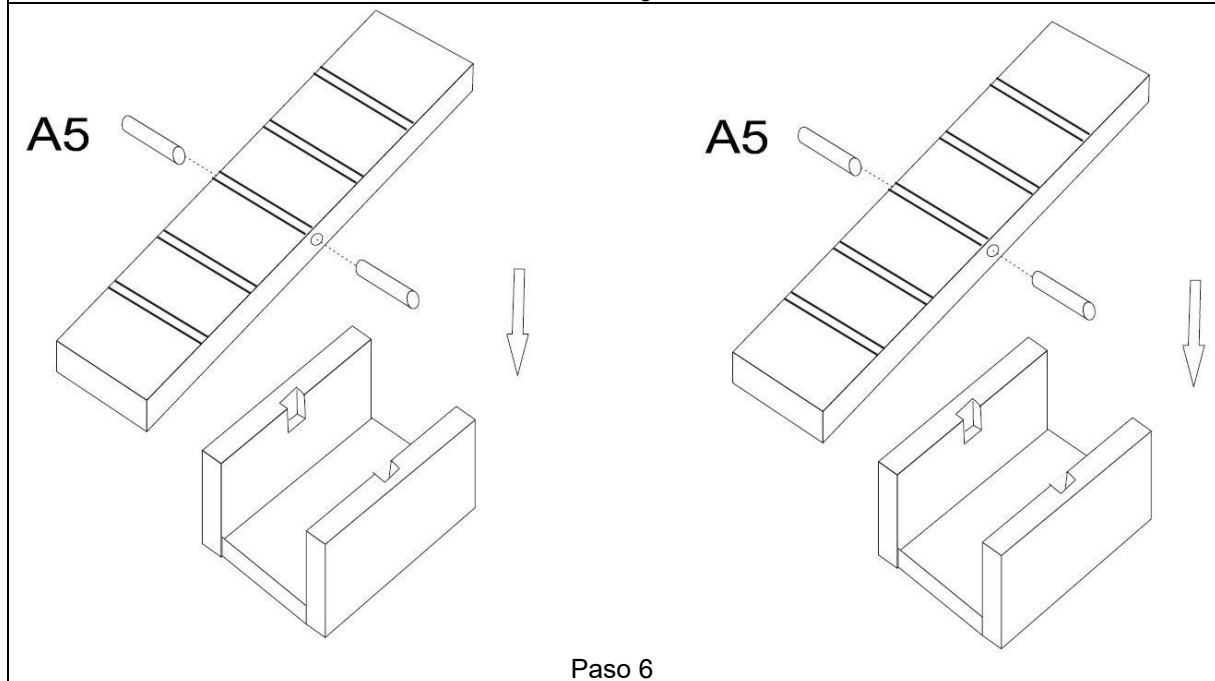
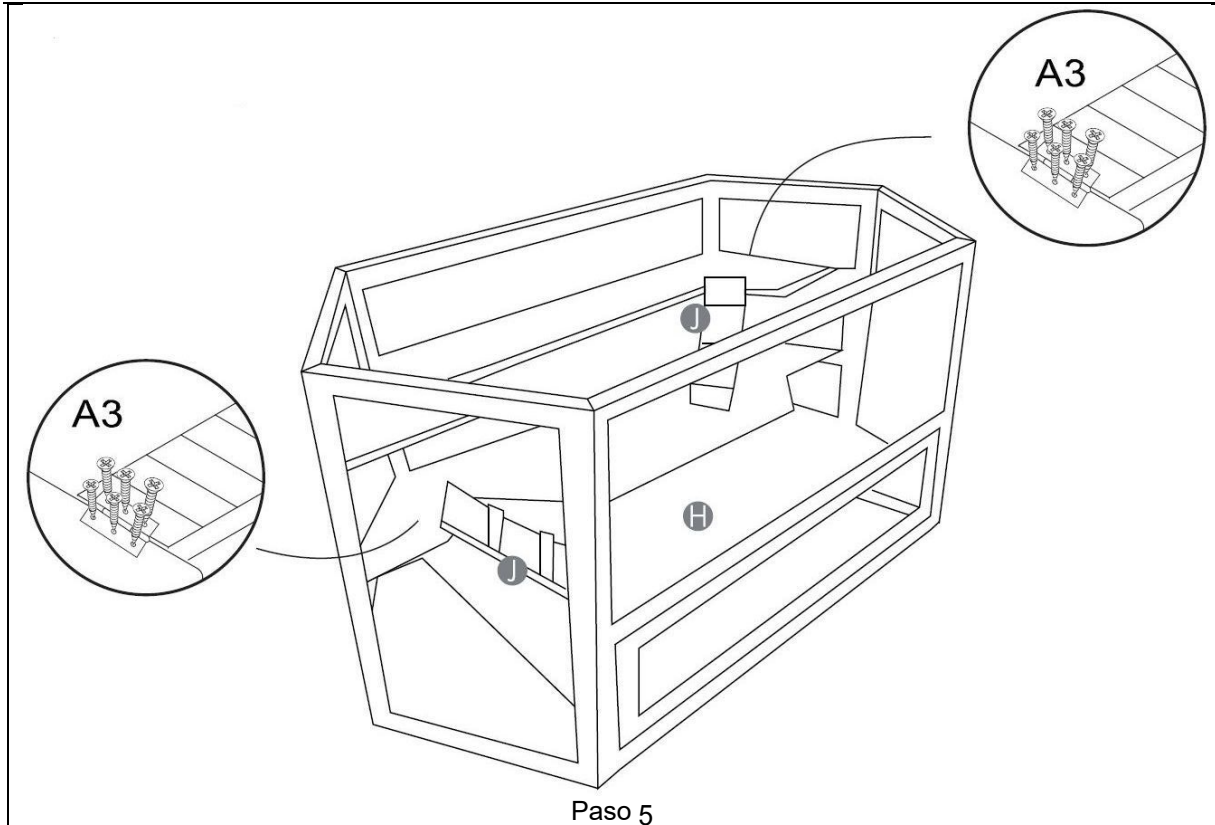

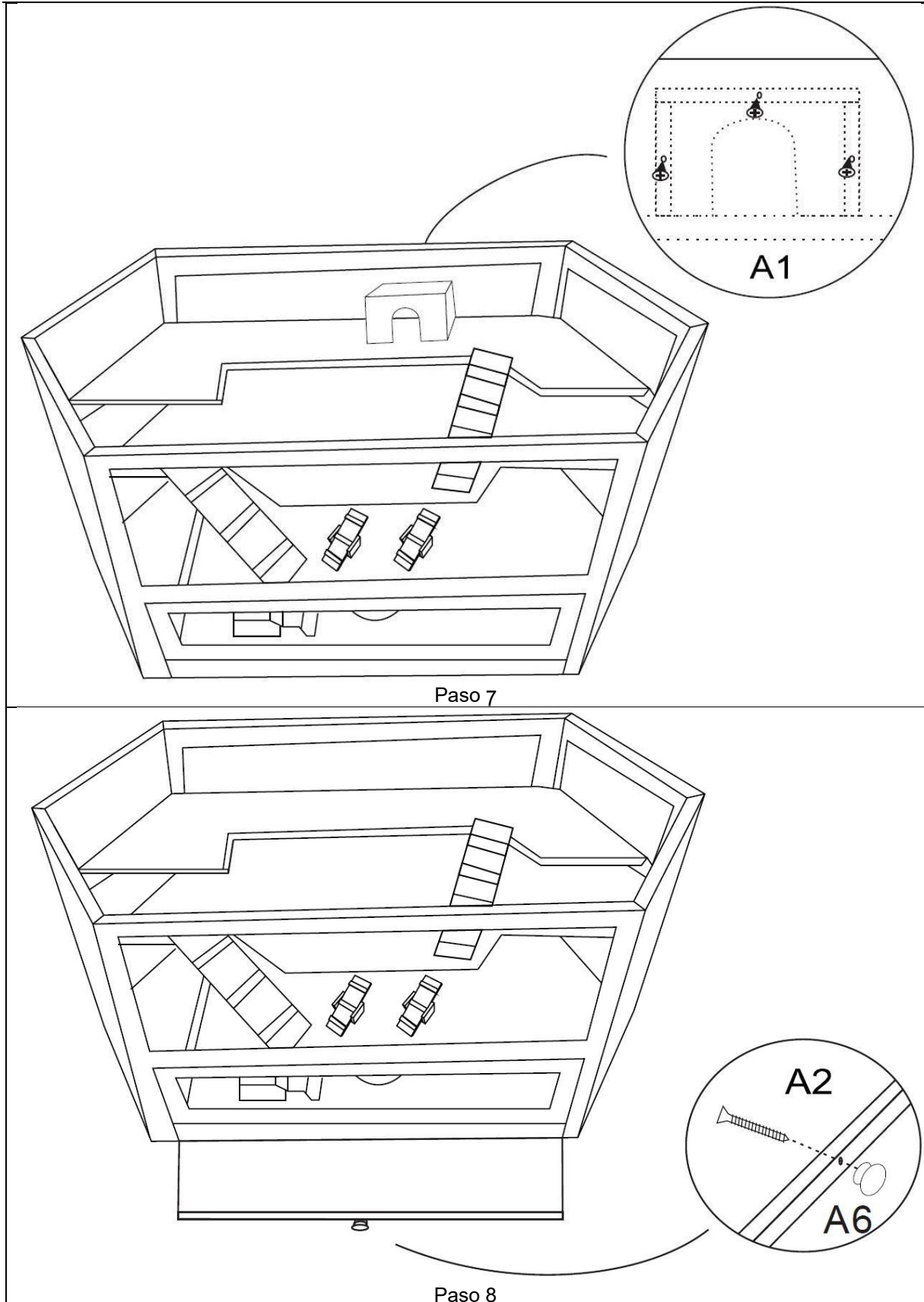

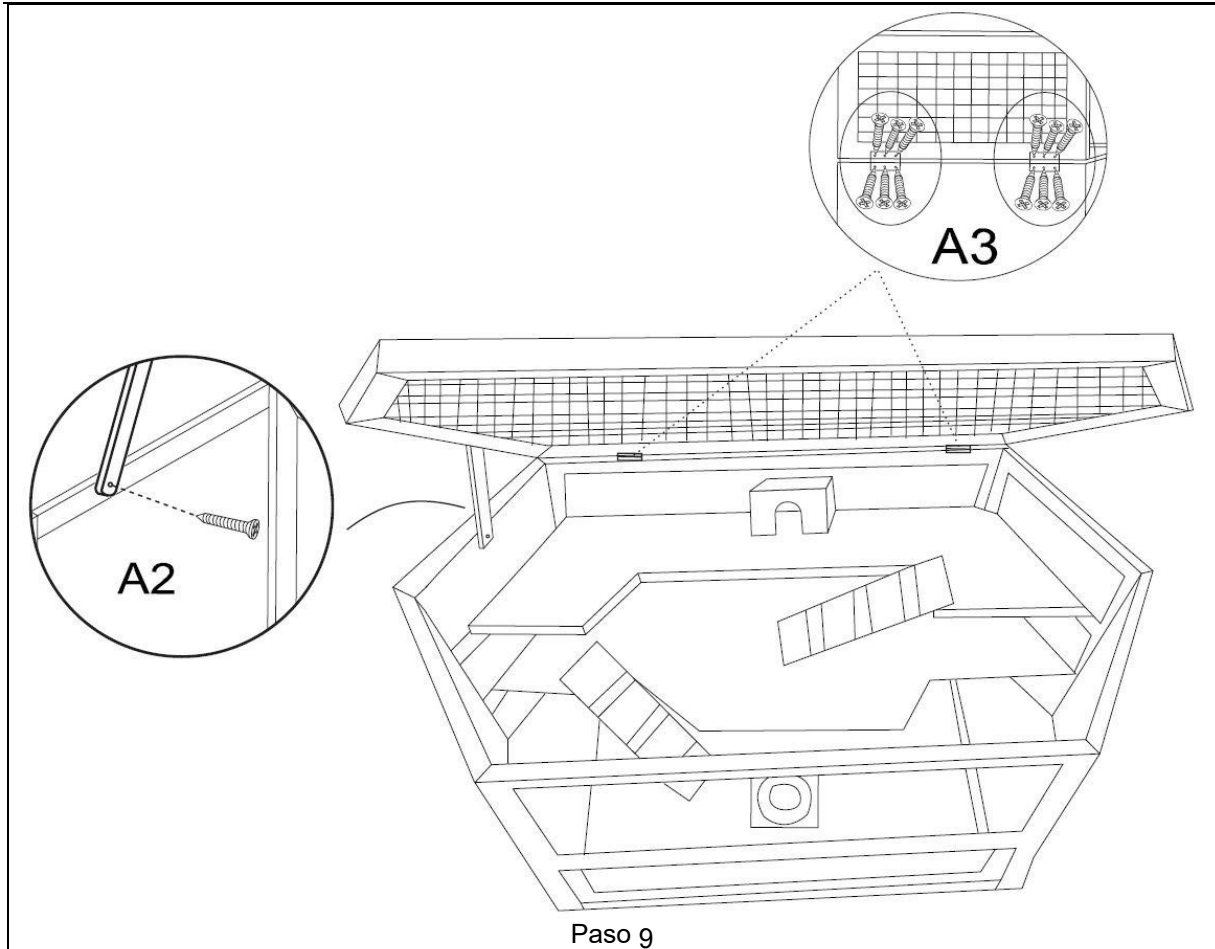

Aviso importante:

Reimpresión, incluyendo extractos y cualquier uso comercial, incluyendo partes del manual, sólo con el permiso escrito de WilTec Wildanger Technik GmbH.