

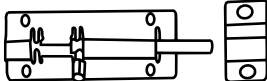









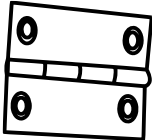

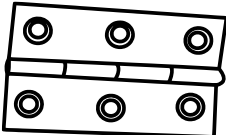
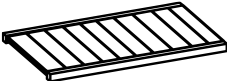

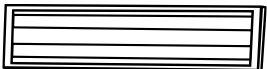

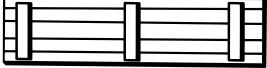
Buchst.	Abbildung	Anz.	Buchst.	Abbildung	Anz.
A		1	K		1
B		1	L		2
C		1	M		2
D			N	 M6×40	14
E			O	 M4×30	37
F			P	 M3×16	26
G			Q		1
H		1	R		1
I		1	S		1
J					

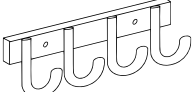
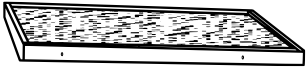

Schritt 1 | N (4)

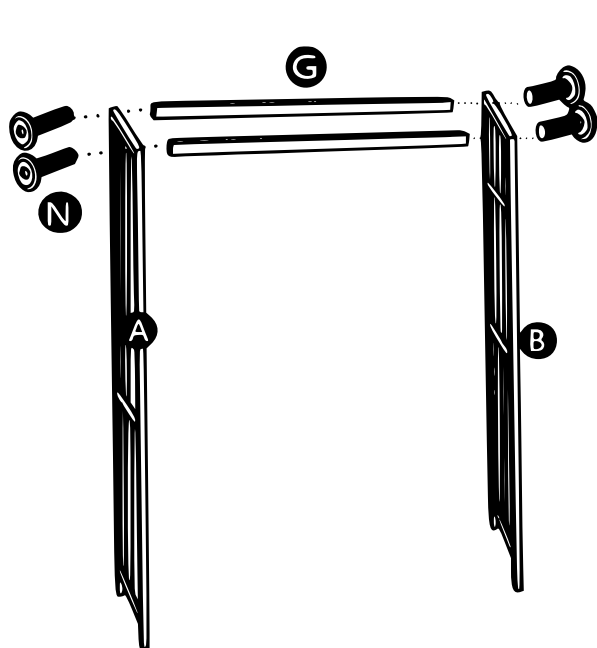
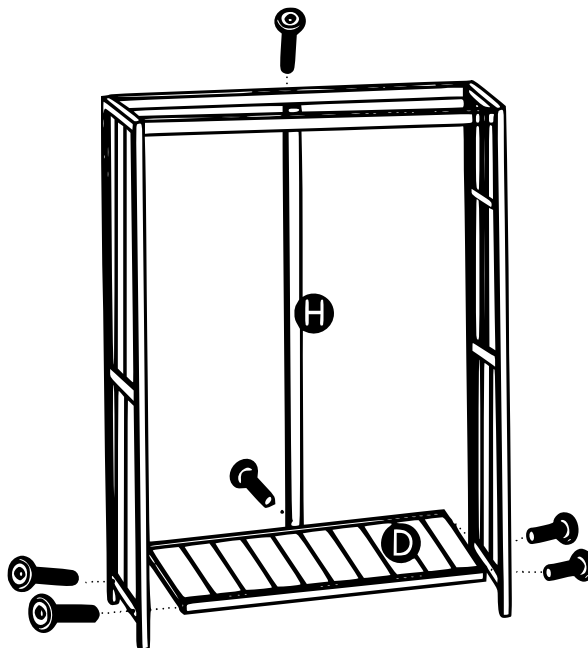

Schritt 2 | N (6)

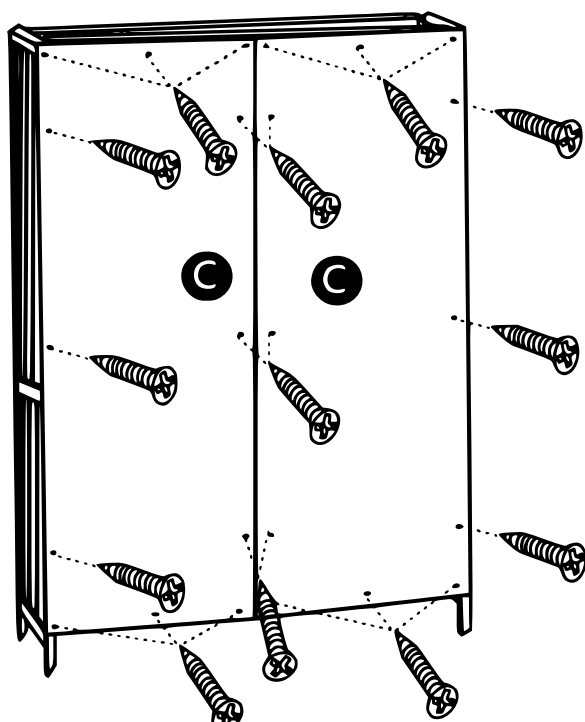

Schritt 3 | O (24)

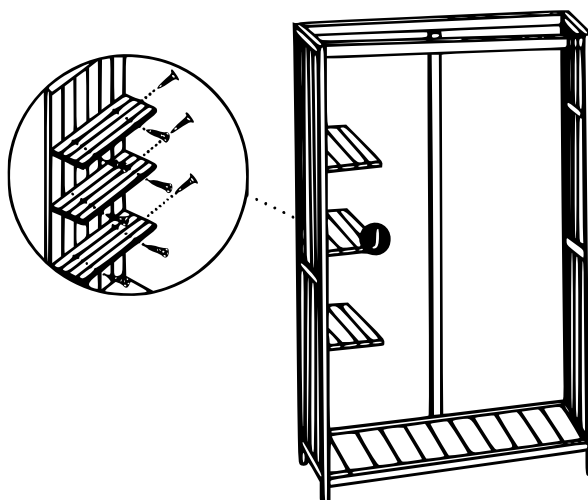

Schritt 4 | O (9)

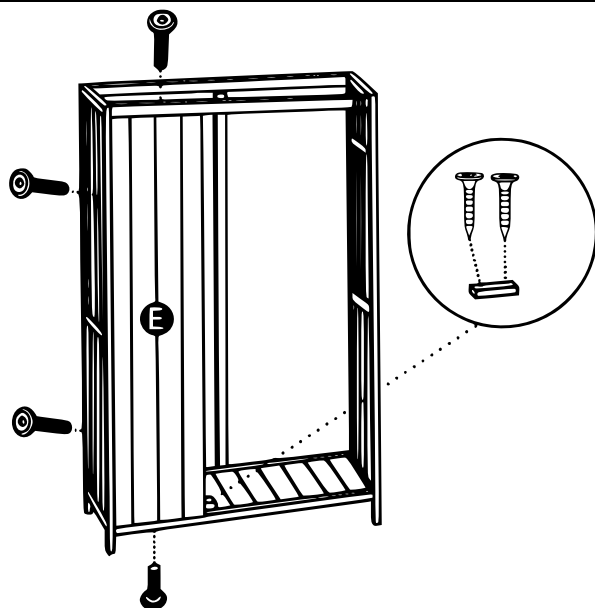

Schritt 5 | N (4) | O (6)

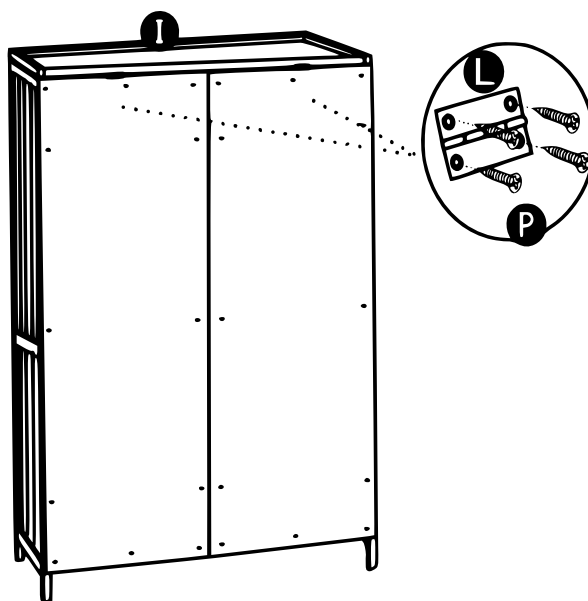

Schritt 6 | P (8)

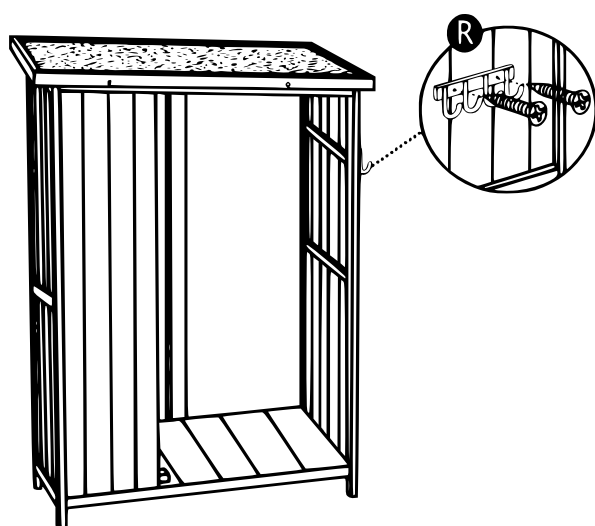

Schritt 7 | O (2)

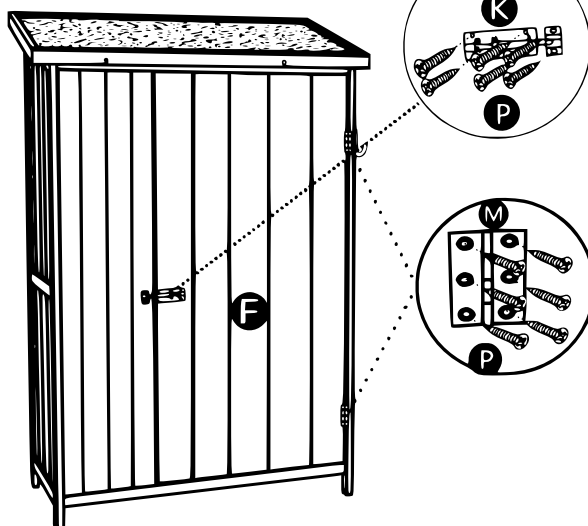

Schritt 8 | P (18)

Wichtiger Hinweis:

Nachdruck, auch auszugsweise, und jegliche kommerzielle Nutzung, auch von Teilen der Anleitung, nur mit schriftlicher Genehmigung, der WilTec Wildanger Technik GmbH.