

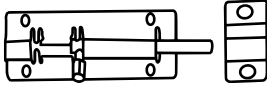









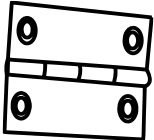

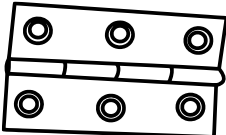
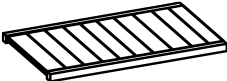

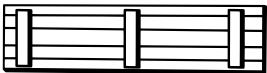

Lettera	Figura	Qtà	Lettera	Figura	Qtà
A		1	K		1
B		1	L		2
C		1	M		2
D			N	 M6×40	14
E			O	 M4×30	37
F			P	 M3×16	26
G			Q		1
H		1	R		1
I		1	S		1
J					

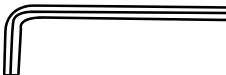

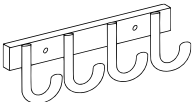
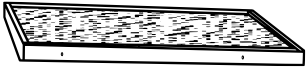

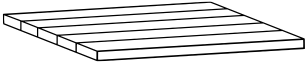
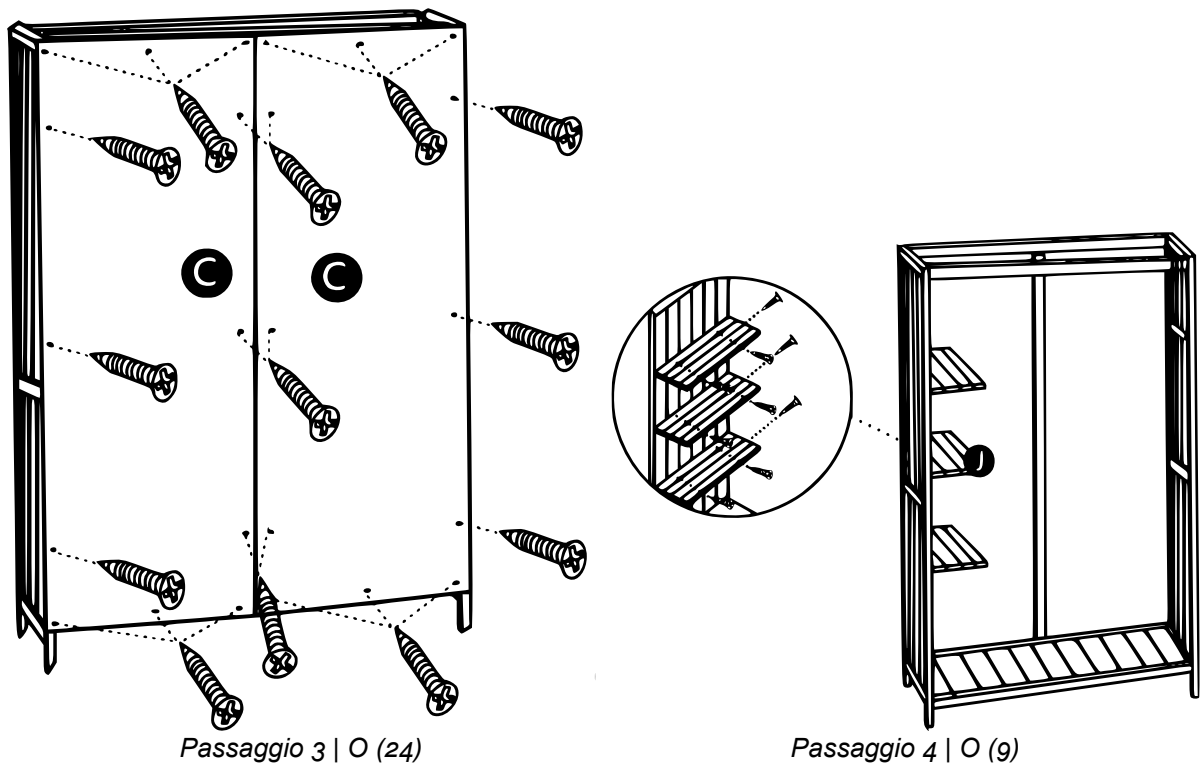
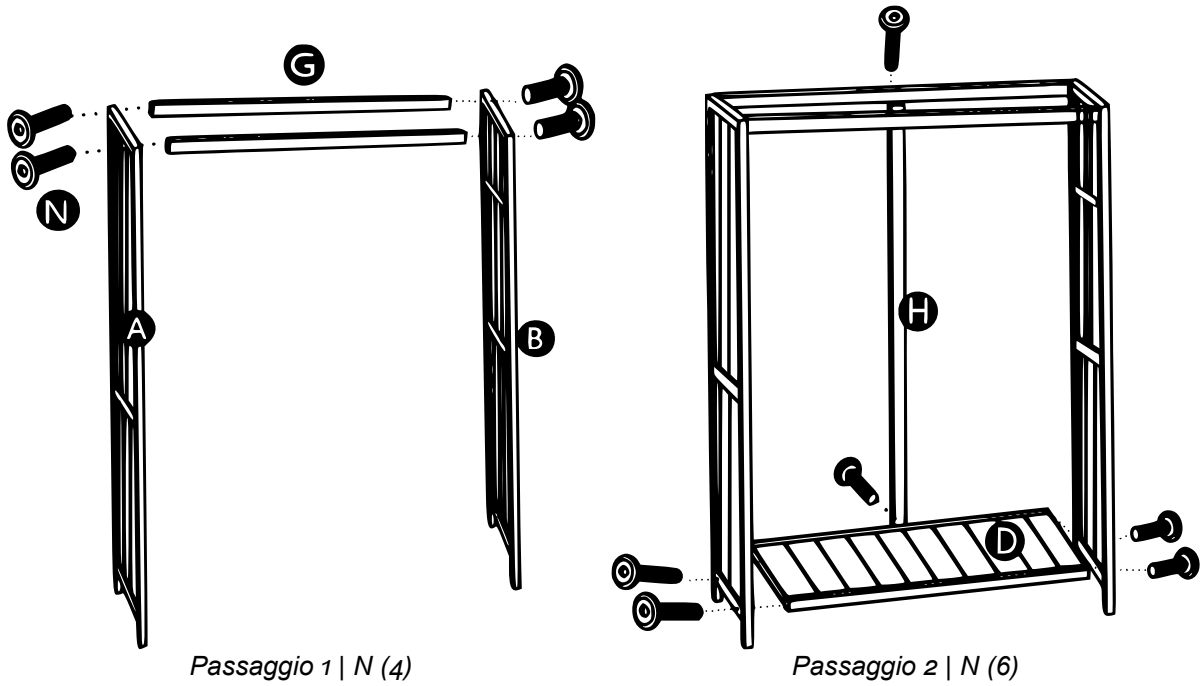
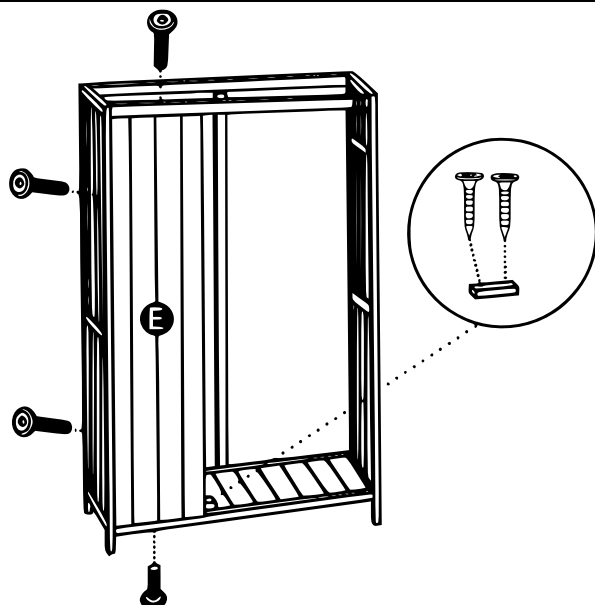
Passaggio 5 | N (4) | O (6)

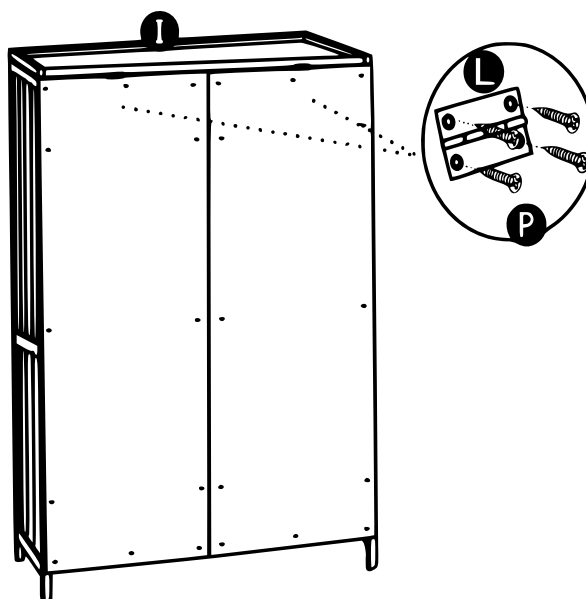

Passaggio 6 | P (8)

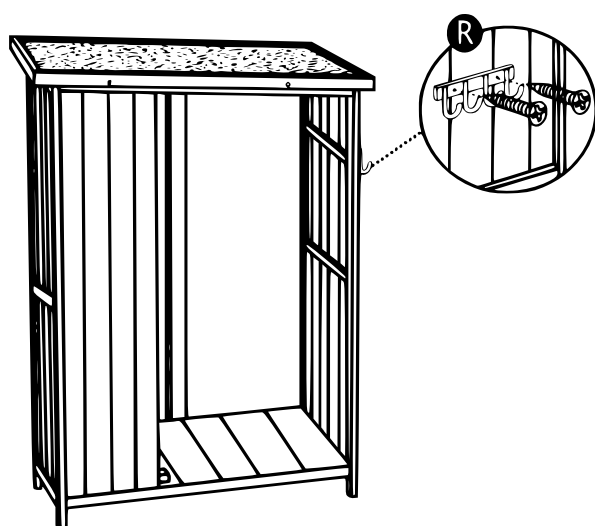

Passaggio 7 | O (2)

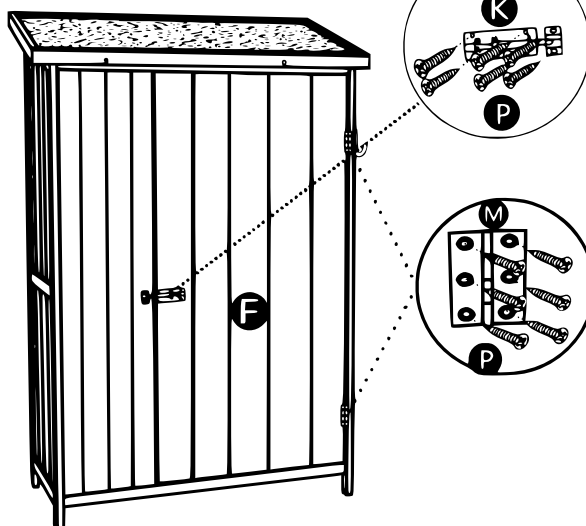

Passaggio 8 | P (18)

Avvertenza importante:

La riproduzione e l'uso ai fini commerciali di una parte o di tutto il manuale sono consentiti solo previa autorizzazione scritta di WilTec Wildanger Technik GmbH.