











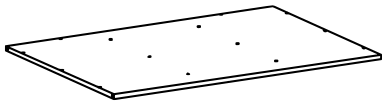
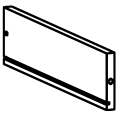

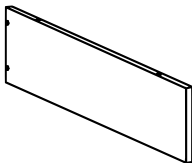
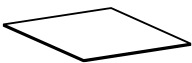
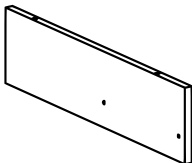
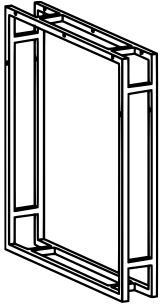
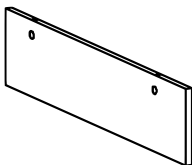
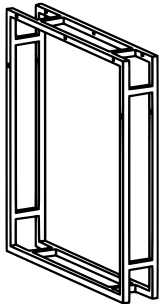
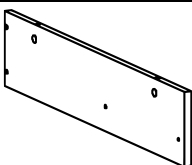

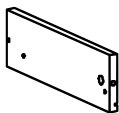

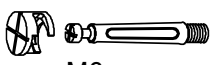
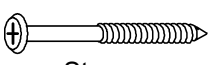
Nr.	Afbeelding	Aant.	Nr.	Afbeelding	Aant.
1		1	9		2
2		1	10		2
3		1	11		2
4		1	12		2
5		1	13		1
6		1	14		1
7		1	15		2
8		2			1

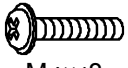
A	B	C	D1	D2
 St7×40	 M6×35	 St5×50	 St4×10	
22	14	10	4	4

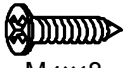
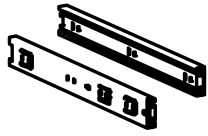

E1	E2	F	G	H
 M4x18		 M4x18		
4	2	16	4	10

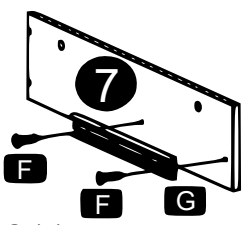
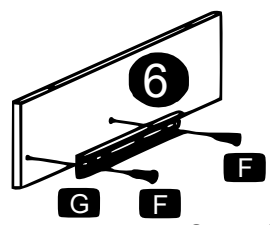
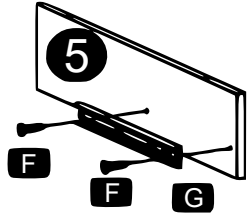
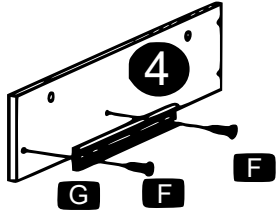

Stap 1 | F (8), G (4)

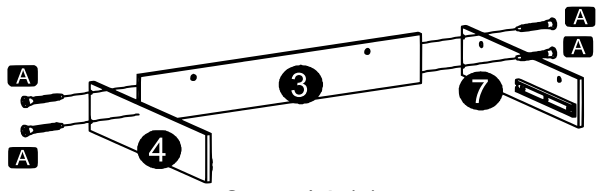

Stap 2 | A (4)

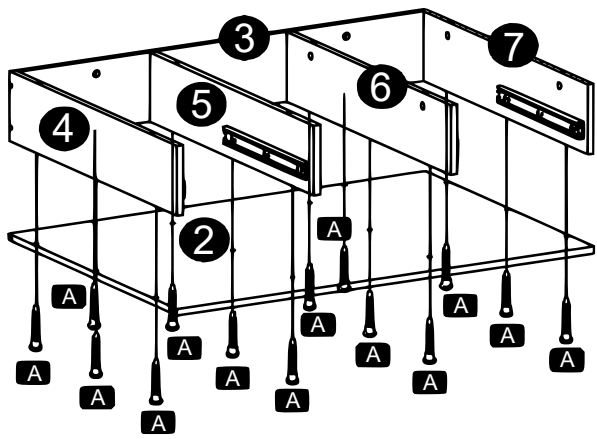

Stap 3 | A (14)

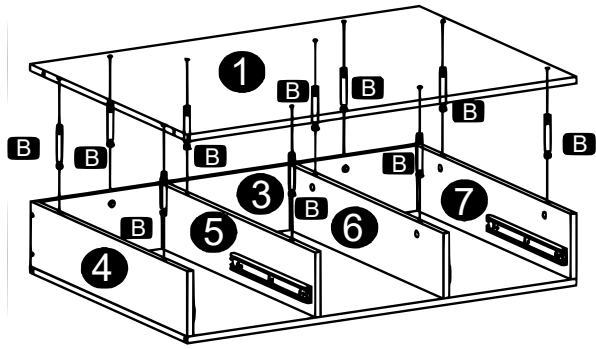

Stap 4 | B (10)

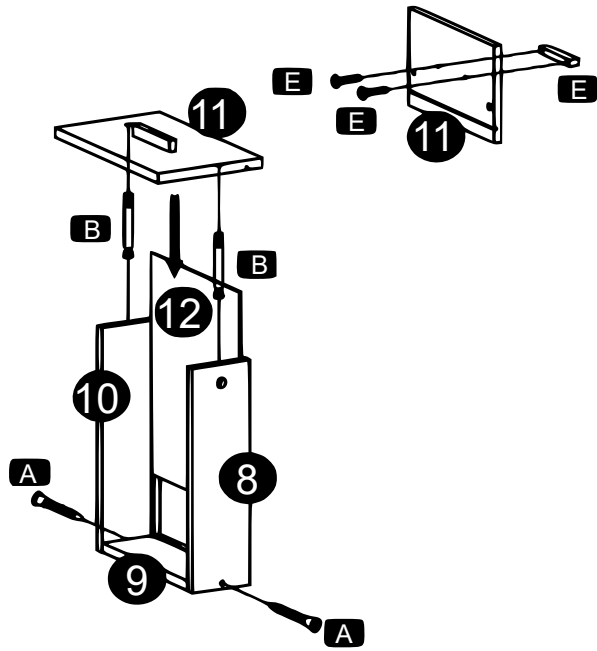

Stap 5 | B (2), E1 (1), E2 (2), A (2)

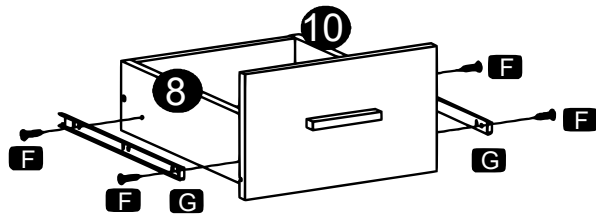

Stap 6 | G (2), F (4)

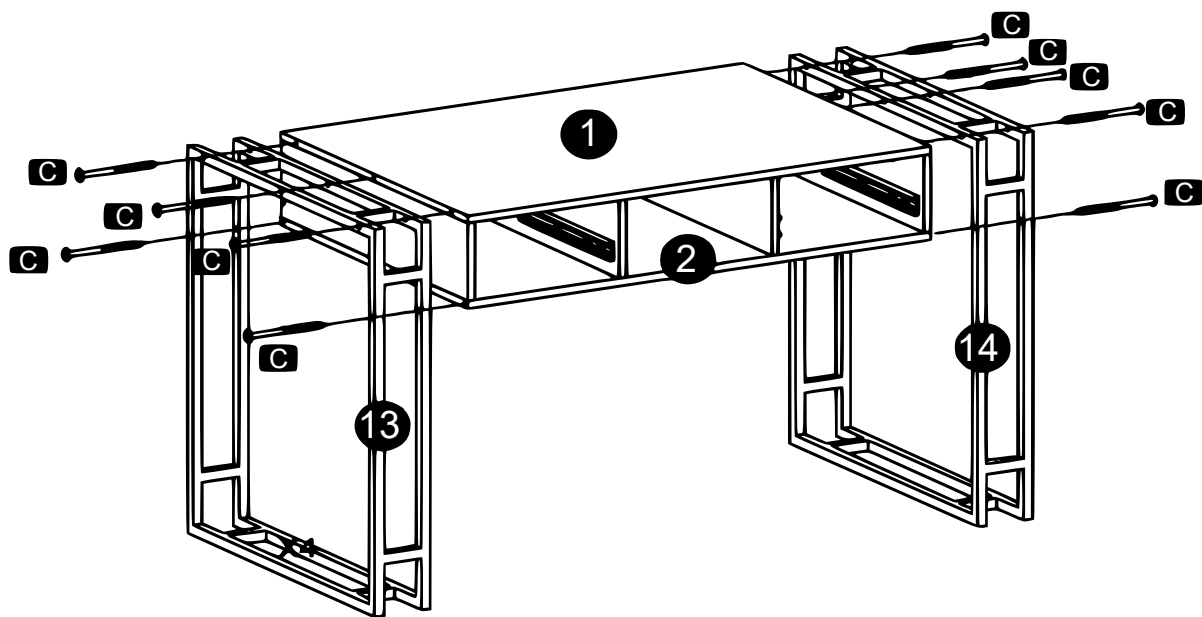

Stap 7 | G (10)

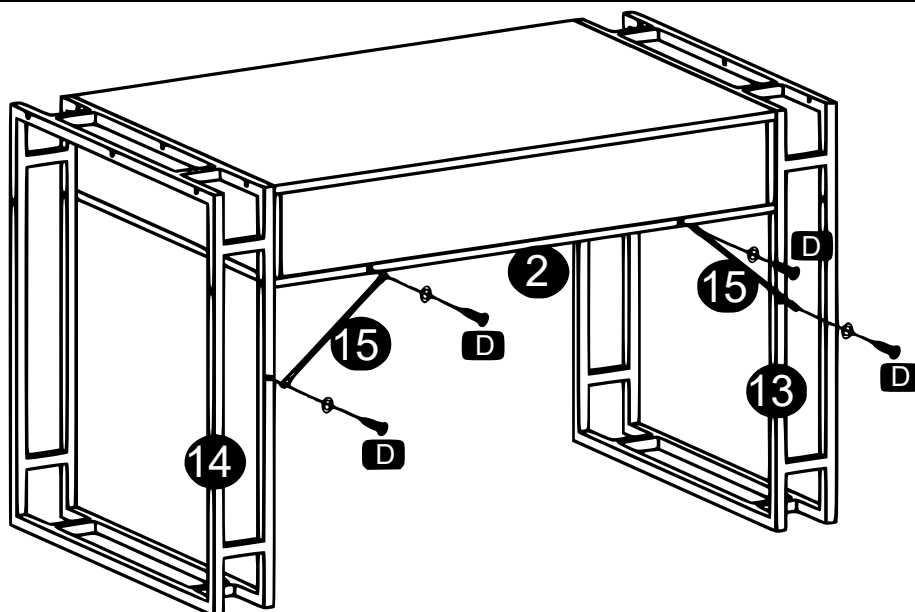

Stap 8 | D1, D2 (4)

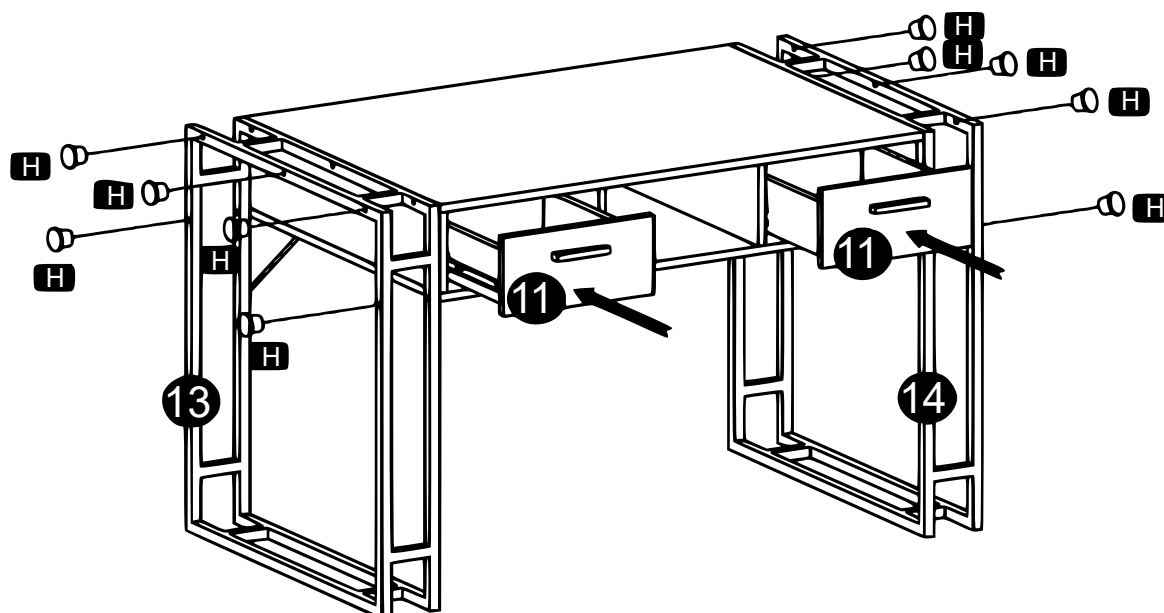

Stap 9 | H (10)

GEBRUIK VAN DE
EXCENTRISCHE
SCHROEVEN

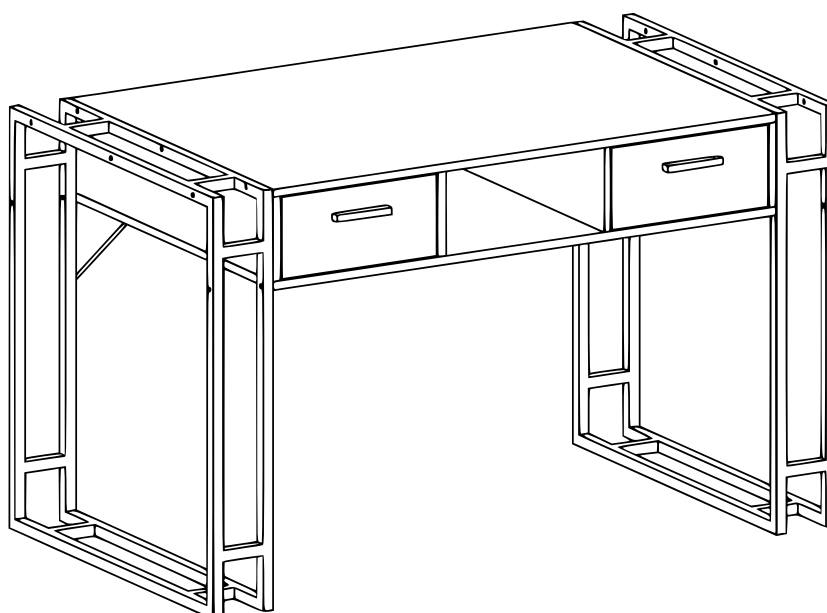
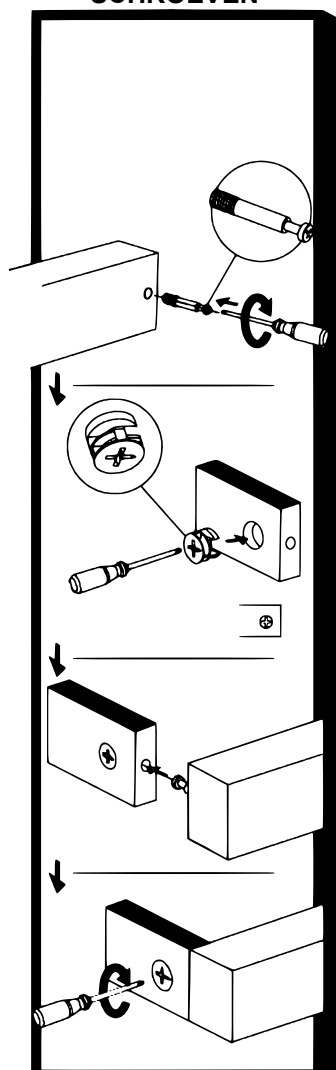

Belangrijk:

Het op welke manier kopiëren van deze handleiding en /of gebruik ervan voor commerciële doeleinden, is alleen toegestaan met schriftelijke toestemming van WilTec Wildanger Technik GmbH vooraf.