



















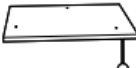

62103–62109 – Krabpaal

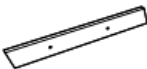
①		M8X80	14	H		Ø30	2
②		M8X40	13	I		Ø7X48	3
③		M8X20	5	J		Ø7X37	4
④			1	K		Ø7X27	2
A		60X45	1	L		Ø7X21	4
B		60X45	1	M			1
C		54X24	1	N		40X7	2
D		34X30	1	O		40X7	2
E		40X34X25	1	P		Ø4X11	4
F		40X34X25	1	Q		Ø7X1.5	1
G		Ø20X20	1	R		Ø7X37	4

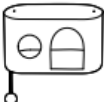
1

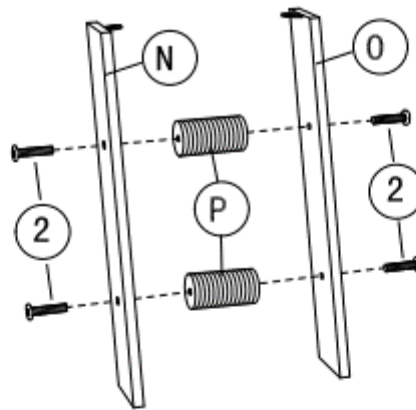

2

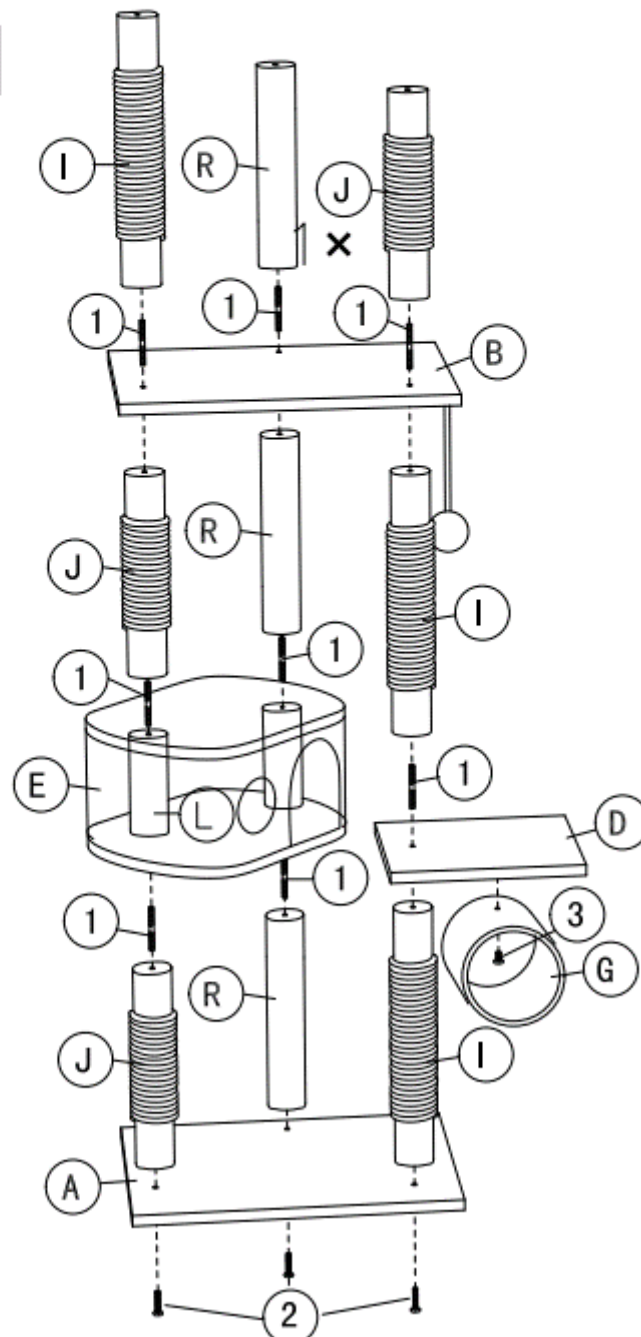

3

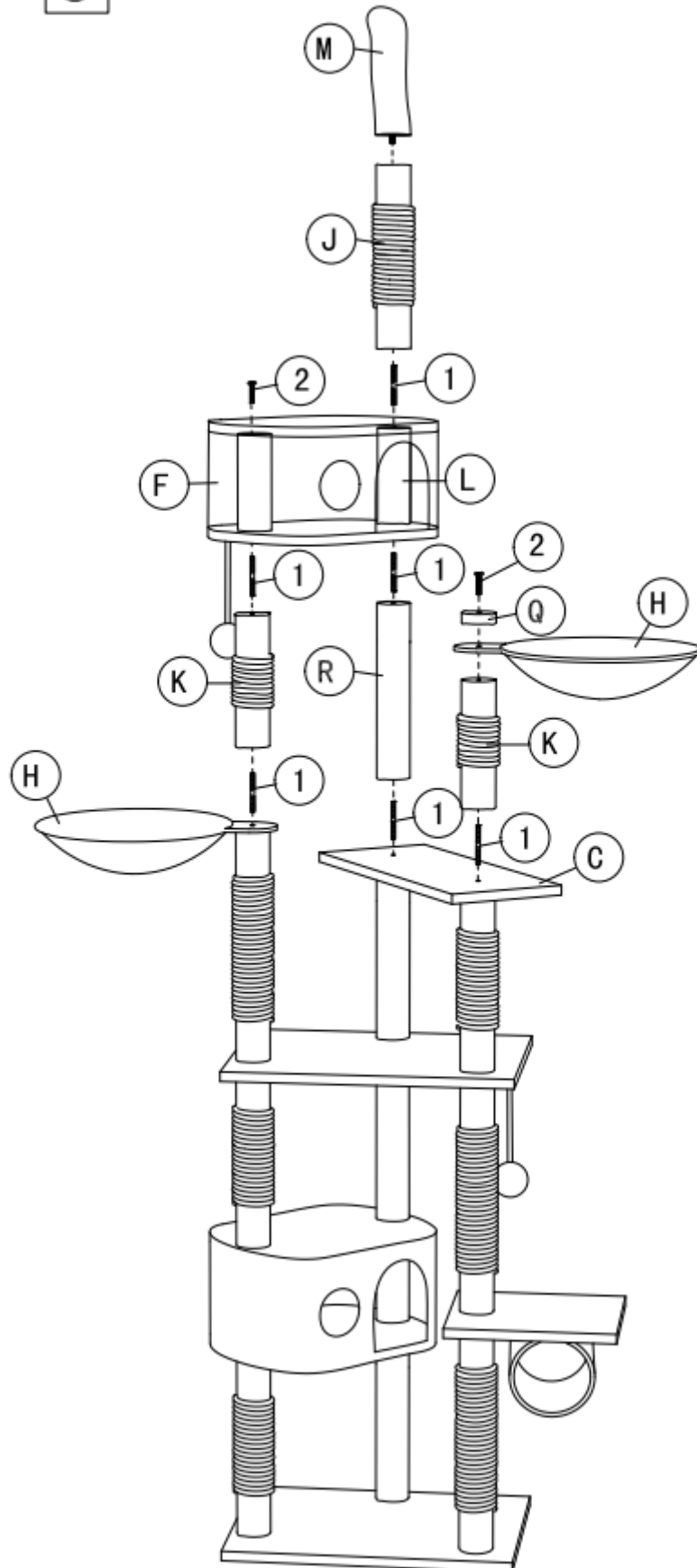

4

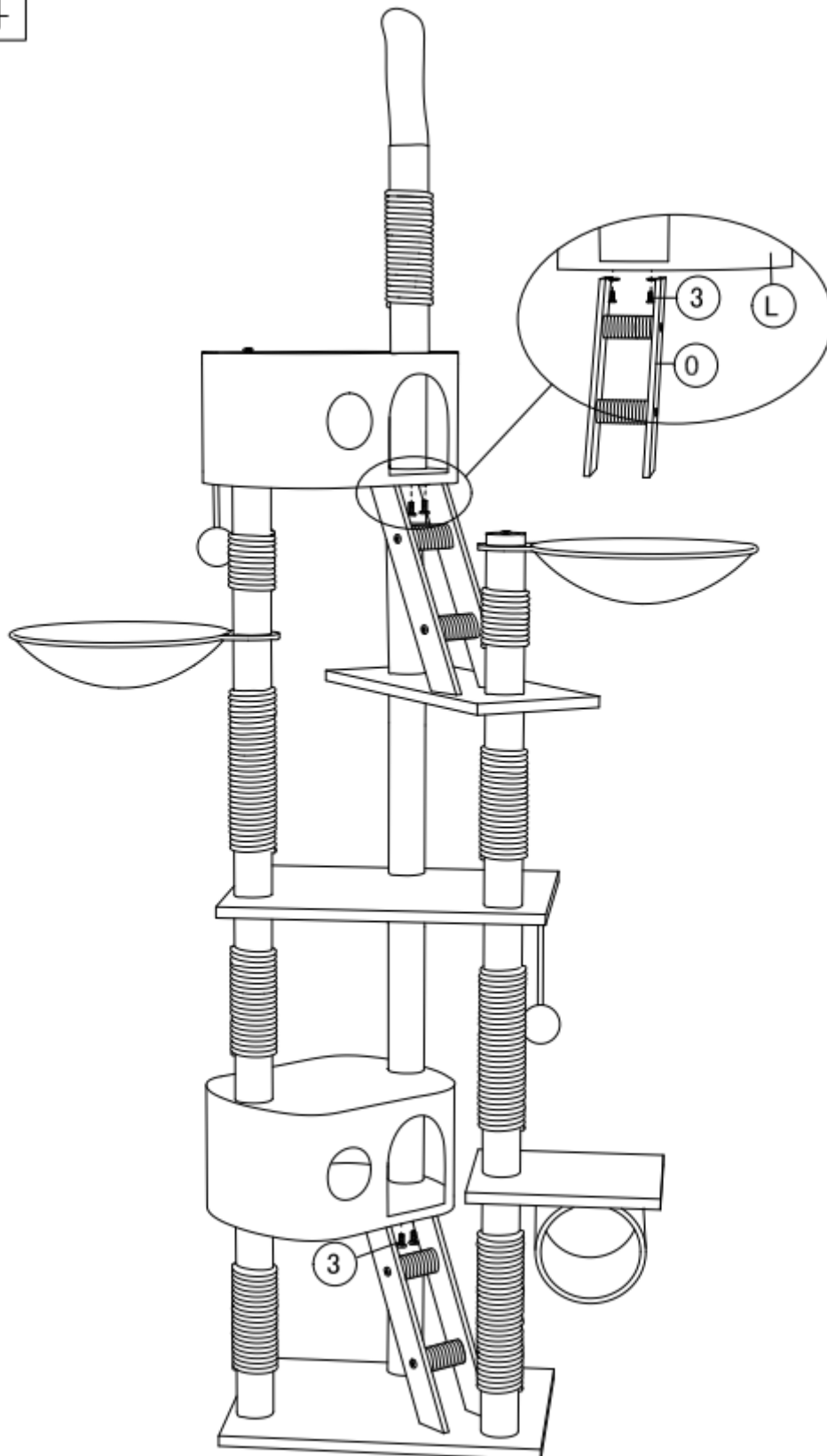

Belangrijk: Het op welke manier kopiëren van deze handleiding en/of gebruik ervan voor commerciële doeleinden, is alleen toegestaan met schriftelijke toestemming van WilTec Wildanger Technik GmbH vooraf.