

Operation Manual

Paint Sprayer 62567



Illustration similar, may vary depending on model

Read and follow the operating instructions and safety information before using for the first time.

Technical changes reserved!

Due to further developments, illustrations, functioning steps, and technical data can differ insignificantly.

Updating the documentation

If you have suggestions for improvement or have found any irregularities, please contact us.



The information contained in this document may alter at any time without previous notice. It is prohibited to copy or spread any parts of this document in any way without prior written allowance. All rights reserved.

The WilTec Wildanger Technik GmbH cannot be held accountable for any possible mistakes in this operating manual, nor in the diagrams and figures shown.

Even though, the WilTec Wildanger Technik GmbH has undergone biggest possible efforts to ensure that the operating manual is complete, faultless, and up to date, mistakes cannot be entirely avoided.

If you should find a mistake or wish to make a suggestion for improvement, we look forward to hearing from you.

Send an e-mail to:

service@wiltec.info

or use our contact form:

<https://www.wiltec.de/contacts/>

The most recent version of this manual in various languages can be found in our online shop via:

<https://www.wiltec.de/docsearch>

Our postal address is:

WilTec Wildanger Technik GmbH
Königsbenden 12
52249 Eschweiler
Germany

Returns Department
WilTec Wildanger Technik GmbH
Königsbenden 28
52249 Eschweiler

E-mail: **service@wiltec.info**

Tel: +49 2403 55592-0

Fax: +49 2403 55592-15



Introduction

Thank you for purchasing this quality product. **To minimise the risk of injury we urge that our clients take some basic safety precautions when using this device. Please read the operation instructions carefully and make sure you have understood its content.**

Keep these operation instructions safe.

Safety precautions

General safety precautions

- **Warning!** Make sure to carefully read the instructions and information contained within this operation manual and always abide by them. Non-compliance may cause fire and lead to property damage, severe injuries or even death.
- Be aware that the safety instructions cannot cover all potential dangers that might occur while operating the device. It is therefore necessary to remain attentive and to operate the device with care.
- This device can only be used by individuals with reduced physical, sensory, or mental capabilities, or lack of experience and/or knowledge if they have received instructions concerning the use of the appliance from and are being supervised by a person familiar with the product and responsible for their safety. Children are not allowed to operate the device and should be always supervised to ensure that they do not play with it.

Workplace safety

- **Always keep your working area clean and well-lit.** Cluttered or dark working areas greatly increase the risk of accidents.
- **Only use the device within well ventilated areas.** Paint thinner and solvents may emit hazardous vapour that might lead to severe health issues if inhaled.
- **Do not use the paint sprayer near flammable objects, liquids, gases and dust, or explosive environments of any kind.** Using the paint sprayer might create sparks that could ignite flammable substances and objects.
- **Keep children and bystanders away from the working area.** People entering the working area might cause distractions, leading to the loss of control over the device.

Electric safety

- **The power plug of the device must match the socket. Never modify the power plug and do not use adapters when working with earthed paint sprayers.** Using original plugs in combination with matching socket-outlets greatly reduces the risk of accidents.
- **Avoid contact with earthed surfaces such as pipes, refrigerators, heaters, and cookers.** An earthed body increases the risk of electric shock.
- **Do not expose the device to rain or environments with high levels of humidity.** Water or moisture entering the device greatly increases the risk of electric shock.
- **Handle the power cord with care. Do not pull at the power cord or abuse it to lift, carry or fix the device. Further ensure that the power cord is not being pinched, and keep it away from heat, oil, and sharp edges.** Entangled or damaged power cords greatly increase the risk of electric shock.
- **When intending to use the device outside, make sure to use an extension cord suited for outdoor use.** The use of an earth leakage circuit breaker greatly decreases the risk of electric shock.

Personal safety

- **Stay attentive. Concentrate on what you are doing and use the paint sprayer responsibly and with care. Do not use the device if you are tired or under the influence of alcohol, drugs, or medicine.** Carelessness might injure the user or people nearby.



- **Dress accordingly. Do not wear loose clothing or jewellery, and keep long haired tied up or covered. Further make sure to keep hair, clothes and especially gloves away from moving parts.** Loose clothes, accessories and long hair increase the risk of injury as they might get caught in moving parts.
- **Avoid unintentional activation of the device. Always make sure that the power switch of the device is turned off before connecting it to the mains supply.** Do not carry the device at the trigger and do not connect it to the mains supply if its power switch is turned on.
- **Do not lean too much forward. Always make sure to keep balance and a secure stand.** Good balance and a secure stand increase the control over the device in unexpected situations and thereby decrease the risk of accident.
- **Wear appropriate protective equipment.** When working with this device, ensure to wear a protective mask, protective goggles, work gloves and non-skid safety shoes.

Safety during use and care

- **Do not force the device. Always use nozzles appropriate for the task to be done.** Suitable nozzles work more efficiently and safely if used at the speed that they are designed for.
- **Do not use this device if its power switch cannot be turned on and off correctly.** Do not use the paint sprayer if its power switch is damaged or cannot be operated correctly. A malfunctioning power switch is dangerous, needing repair before the device can be used again.
- **Properly disconnect the device from the mains supply before exchanging equipment or performing any kind of cleaning, repairs, or maintenance work.** Disconnecting the device from the mains supply before any adjustments prevents it from accidentally turning on and decreases the risk of accidents.
- **Always make sure to store this device in a location inaccessible to children and do not let individuals unfamiliar with the device or this operation manual operate it.** This paint sprayer can be dangerous if used by an inexperienced user.
- **Perform maintenance on a regular basis. Carefully check the device and especially its moving parts for obstructions as well as signs of deformation, damage, wear or any other condition that might affect the performance of the device. Make sure to have it repaired by qualified personnel in case of wear, damage or any other performance affecting issue.** Many accidents involving paint sprayers are related to poorly maintained devices.
- **Always use the device in accordance with the information and instructions found in this operation manual and consider local regulations, working conditions as well as the task to be performed.** Inappropriate use of the device is dangerous, greatly increasing the risk of accidents.

Safety during maintenance

Maintenance and repair work must be performed by qualified personnel and spare parts used must be of equal quality. This ensures a consistent quality of the performance as well as high safety standards.

Paint sprayer safety precautions



Risk of injection!

- **Being operated with air pressure, the colour is released with a lot of force.** If used inappropriately, colour might be injected into the skin. This might lead to severe injuries and even amputations. In case of colour accidentally being injected into the skin of a person, immediately contact a doctor. Do not treat an injection wound like a minor cut, since injections may lead to body parts having to be amputated and require immediate surgical treatment.
- **Do not direct the paint sprayer at individuals or animals. Do not hold your hand in front of the nozzle and do not attempt to redirect colour with your hand while operating the**



device. Gloves and fabrics are not a sufficient protection from toxic colours, sealants, impregnation agents or dyes.

- **Do under no circumstances come into contact with a stream of paint, no matter if released from the nozzle or a leak in the hose.** Always make sure to keep the trigger as well as the power cord free from paint.
- **Do not operate the paint sprayer when it is empty.** Operating the device with an empty tank might damage it.
- **Do not use the pain sprayer with asbestos, metallic paint, glass, minium, powdered chalk, bleach, or abrasive, granular or calciferous colours.** The paint sprayer is not intended for processing these materials and might be damaged in the process.
- **Do not use flammable substances in the vicinity of unshielded flames or ignition sources.** Engines, electric devices, and controllers may create electric arcs capable of igniting flammable gases or vapour. Do not store flammable liquids, gases, or other substances near the paint sprayer.
- Always ensure that fire-fighting appliances are available and fully functional.
- Keep the pump away from the spray zone to avoid contact with solvents and paint fumes.
- Only use the paint sprayer with water based or mineral materials.
- Do under no circumstances use bleach, naphthalene, acetone, alcohol, or toluol to clean the device or its accessories.
- Never use solvents with a combustion point below 21 °C to clean devices. Such solvents may cause explosions. Examples for suitable detergents are water, turpentine, and paint thinner. Please note that some of these detergents might be unsuitable for certain types of colours.
- Abide by the security instructions and information provided by the manufacturer of the substances and detergents used.
- Keep the hose away from sharp edges, since leaking or bursting hoses might lead to severe injuries. Regularly check the hose to ensure its integrity and immediately replace it if it should be damaged or show signs of wear.
- Always use the lowest air pressure setting when rinsing the paint sprayer.
- All hoses and components of the paint sprayer need to at least be able to resist a minimum pressure of 206.84 bar (3000 psi).
- The paint sprayer must be connected to a socket-outlet that has been earthed in accordance to the local regulations and prescriptions.
- Be careful when using this device on windy days.
- Do not use the device without nozzle head protection or spray pistol.
- Clean the device after each use to prevent permanent damage and to thereby prolong its service life.
- The casing of the device heats up during operation. Do not touch its casing before it has cooled down entirely.
- Remove the nozzle or set it to its cleaning position **before** cleaning or rinsing the device.
- Do not use pliers to fasten or loosen high pressure connections.



Sparks caused by inappropriate earthing may ignite vapour!

- Abide by all local regulations concerning the use of containers for liquid supply and buckets containing solvents, used for rinsing and cleaning the spray system.
- **Only use conductive metal buckets or containers if they have been placed on an adequately earthed surface (made of concrete). Place buckets on non-conductive surfaces such as paper or cardboard.** Earth all metal buckets by connecting them to earthed objects and structures (e.g., nearby pipes) with help of an earth cable. Make sure to keep them earthed during operation. Keep the earthing active, even when using the pressure of the paint sprayer to rinse the bucket. Further be aware that the pressure emitted by the device can cause the bucket to tilt and therefore ensure to carefully hold in place while pressing the metallic parts of the spray gun against the earthed metal bucket.



- Always make sure to keep the labels and nameplates found on the spray pistol readable as they contain important safety instructions.
- Avoid unintentional activations of the device and be prepared for its operation before starting the device.
- This device is not a toy and must be always kept inaccessible to children.
- Individuals relying on cardiac pacemakers should consult a doctor before using the device. Electromagnetic fields might cause the pacemaker to malfunction.
- **Warning!** Some dust types created by electric grinding, sawing, drilling or other construction work might contain toxic chemicals. Amongst them are:
 - lead from lead-containing colours,
 - crystalline silicon from bricks, concrete, and other materials for wall construction,
 - arsenic and chromium from chemically treated lumber.The risk of exposure varies depending on the frequency with which this kind of work is performed. To reduce the pollution caused by these chemicals, ensure to work in a well-ventilated area and always use authorised safety equipment such as specially designed dust masks capable of filtering microscopic particles.

Always keep this operation manual!

Safety of earthing



Electric shock and electrocution because of improper earthing!

- Contact a qualified electrician if in doubt about the proper earthing of a socket-outlet.
- Do under no circumstances modify the power plug of the device and do not remove its earthing.
- Do not use the paint sprayer if its power cord or power plug show signs of damage or wear. If either the cord or its plug is damaged, the device must not be used and the cable must not be repaired by laymen. Instead, have a qualified electrician replace the cord.
- If the power plug does not match the socket, contact a qualified electrician and have a matching socket-outlet be installed.
- The power plug of the device must be connected to a properly earthed outlet-socket. In case of the paint sprayer malfunctioning, the earthing aids in protecting the user and reduces the risk of electric shock by diverting the current.

Safety of extension cords

- Earthed sprayers require a three-conductor extension cord. Double insulated sprayers, however, can be connected to extension cords with two or three conductors.
- The size and capacity of the extension cord must increase along with the distance from the socket-outlet. Using cables with insufficient size and capacity will lead to a voltage drop, reducing the performance of the sprayer and potentially damaging it.
- If a single extension cord is used for multiple paint sprayers, the ampere indications stated on the each of the respective nameplates must be added to determine the minimum requirements for the extension cord.
- The smaller the wire gauge, the greater the capacity of the wire.
- Always make sure that the extension cord is in pristine condition before connecting it to the device or the mains supply. Do not use worn or damaged extension cords and instead have them be replaced or repaired by a qualified electrician.
- Do not expose extension cords to sharp edges or objects, heat, moisture, or moist environments.

Before commissioning

Familiarise yourself with the device and its functions before beginning its operation.

Principle parts and their names

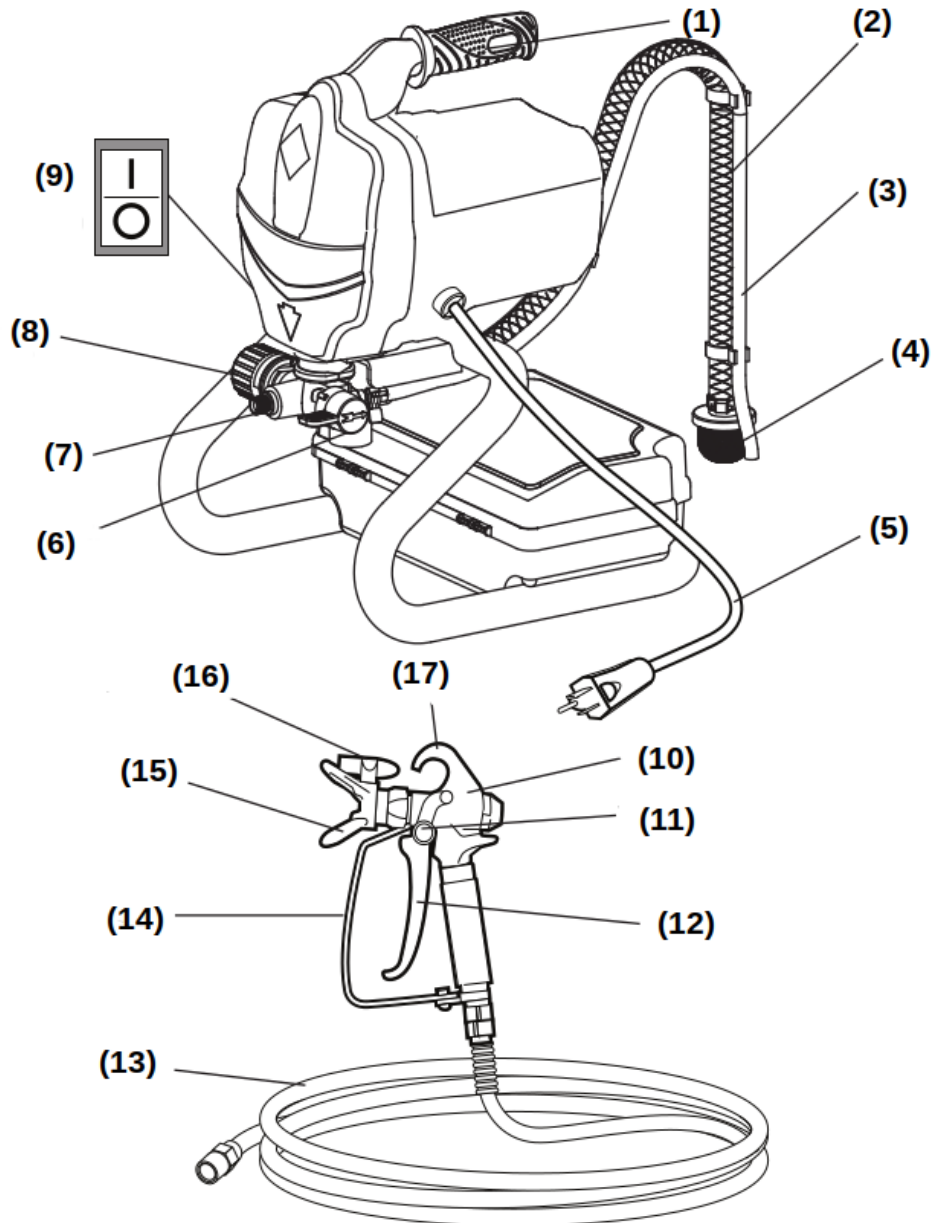

Nº	Name	Nº	Name	Nº	Name
1	Handle	7	Hose outlet	13	Hose
2	Suction pipe	8	Pressure control button	14	Guard
3	Intake pipe	9	On/off switch	15	Nozzle head protection
4	Filter	10	Spray gun	16	Nozzle head
5	Power cord	11	Release lock	17	Suspension hook
6	Mode selector switch	12	Trigger		

Mode selector switch

This switch allows the quick selection of modes. It can activate the spray mode of the device or its aspiration mode

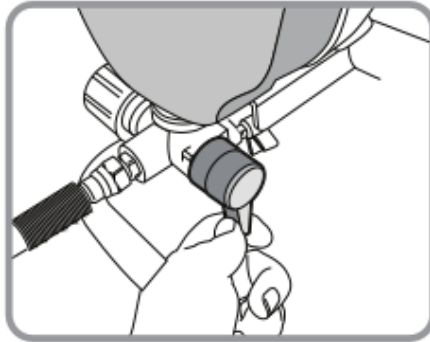

Aspirate

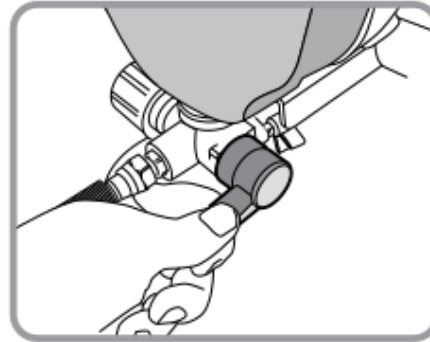

Spray

Release lock

If activated, this lock will prevent the trigger from being activated. **The trigger should always be locked if the spray gun is not in use** as it prevents unintentional activations and reduces the risk of accidents.

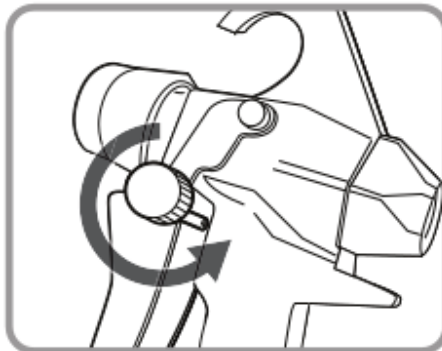

Locked

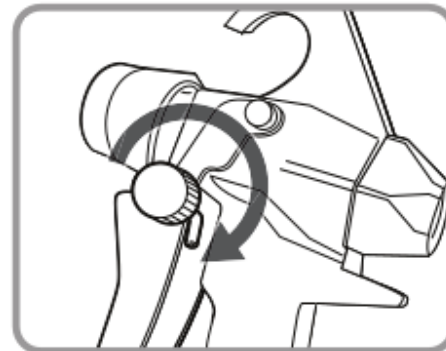

Unlocked

Nozzle head

The nozzle can be turned and removed to facilitate the process of cleaning and clearing possible obstructions. The nozzle can be switched between spray and eject position.

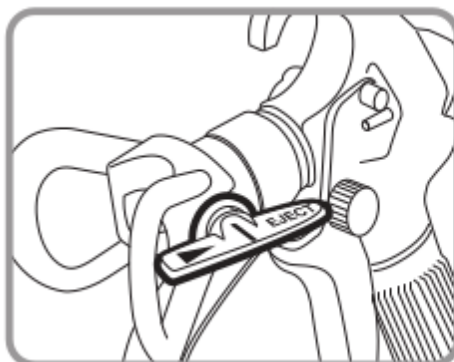

Spray

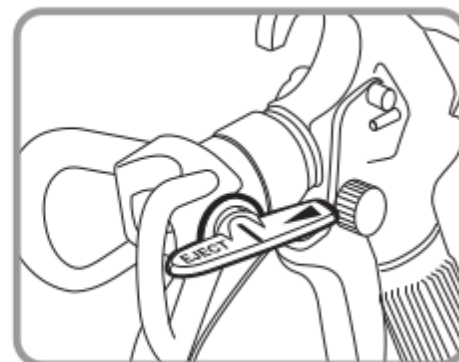

Clean/eject

Pressure control button

The pressure controller allows to switch between high pressure and low-pressure spray modes, a clean and priming mode as well as rolling mode.

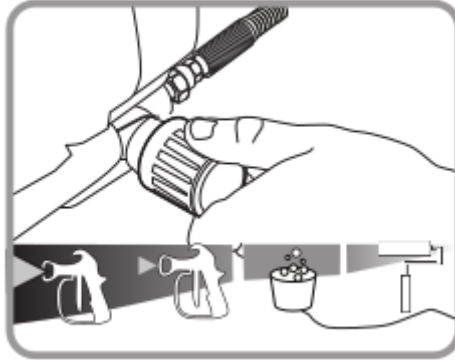

Assembly

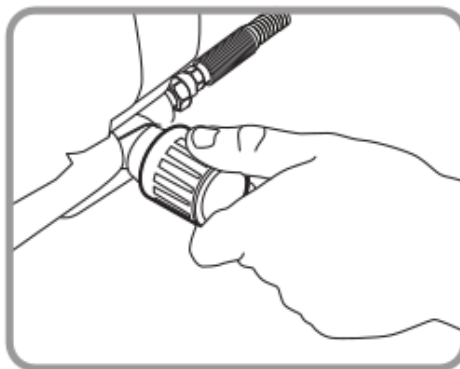
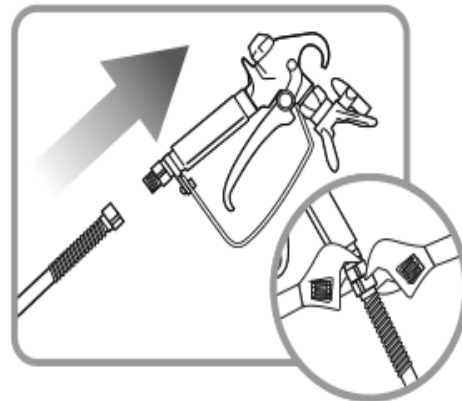
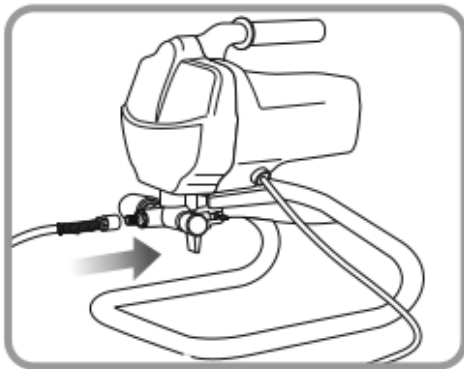

1. Attach the hose to the hose outlet and tighten it by using a wrench.
2. Attach the hose to the spray gun and tighten the fix the connection with 2 wrenches.
3. Set the pressure control button to low pressure spray mode.

Pressure relief

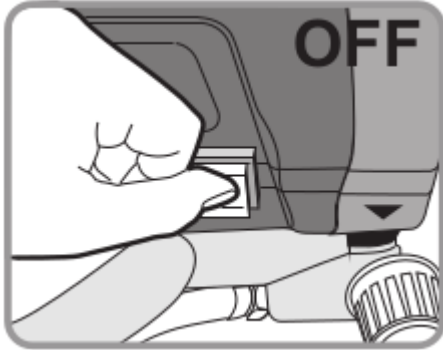

1. Turn the power switch off and carefully disconnect the device from the mains supply.

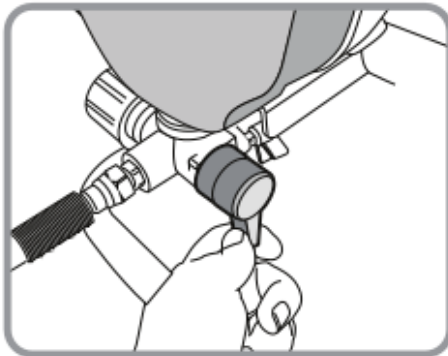

2. Use the mode selector switch to set the device to prime mode.

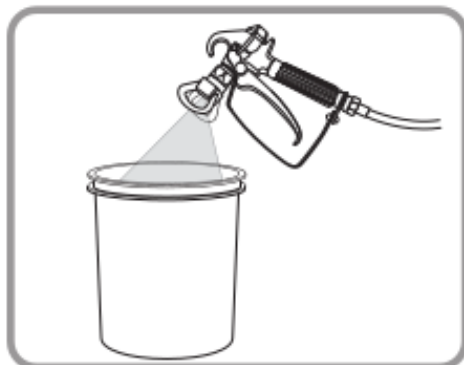

3. Direct the spray gun at a paint bucket and press the trigger to release the pressure.

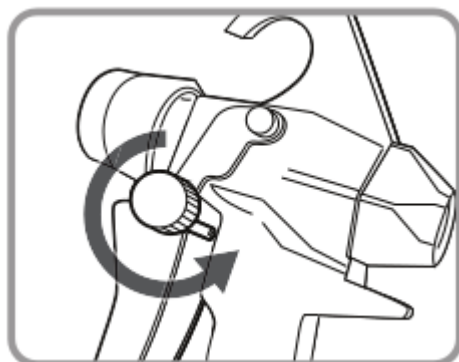

4. Turn the release lock to lock the trigger.

Note: Always set the device to priming mode in between uses.

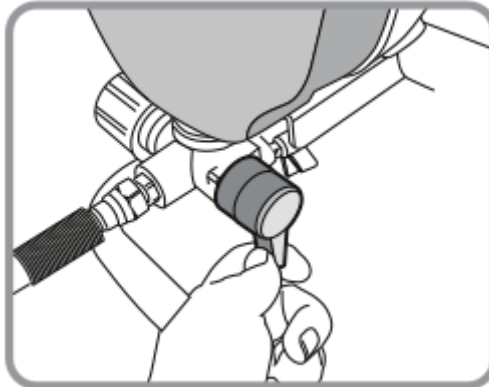

Spray gun priming

This procedure is used for the first application of the spray gun as well as the removal of residual fluids from the spray gun.

Oil-based paint: Rinse the spray gun with white spirit (e.g., turpentine) before then thoroughly rinsing it with warm and clear water.

Warning! To decrease the risk of fire, the spray gun should contact an earthed metal object when the white spirit is applied.

Water-based (latex) paint: Rinse the spray gun with warm and clear water.

Priming and start-up

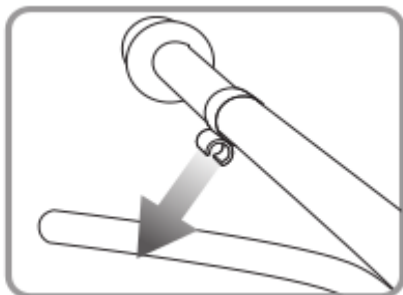

1. Carefully separate the smaller intake pipe from the suction pipe.

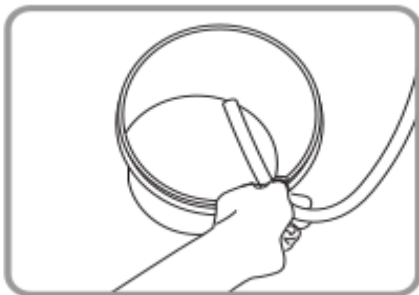

2. Place the intake pipe inside a bucket.

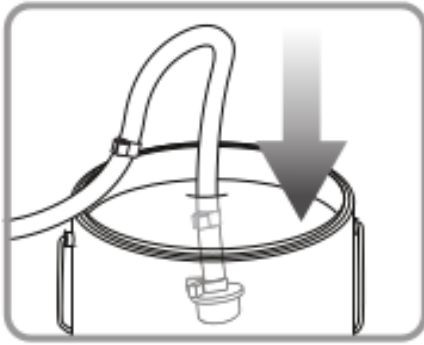

3. Place the suction pipe inside a container filled with water or solvents.

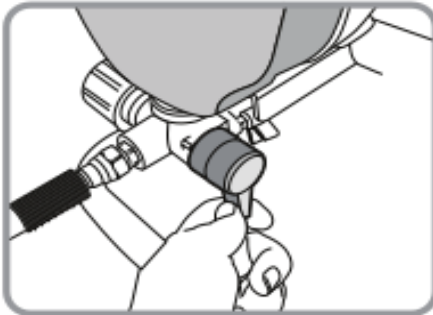

4. Use the mode selector switch to set the device into the aspiration mode.



5. Use the pressure control button to set the device to cleaning and priming mode.

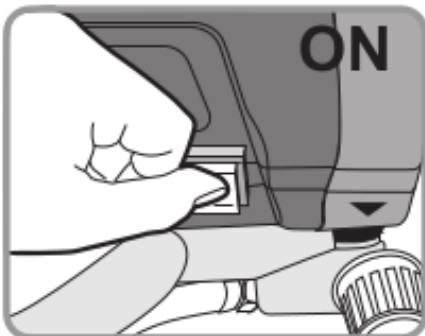

6. Connect the paint sprayer to the mains supply and turn it on.

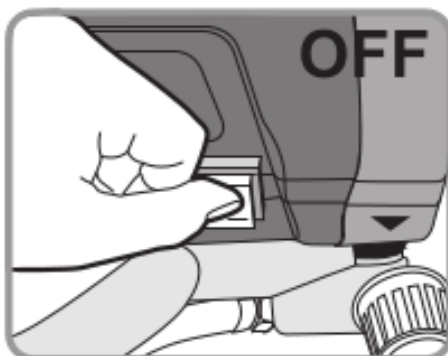

7. The paint sprayer will start pumping and thereby purge the system from residue water/solvent as well as air bubbles. Let the residue run into the bucket for 30 to 60 s, before then turning the device off.

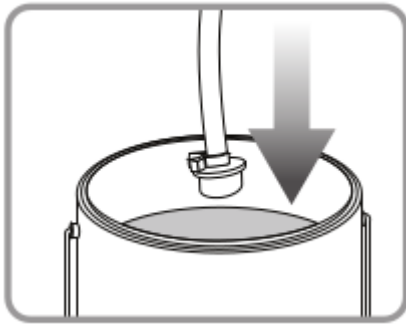

8. Remove the suction pipe from the water/solvent and place it inside a paint bucket

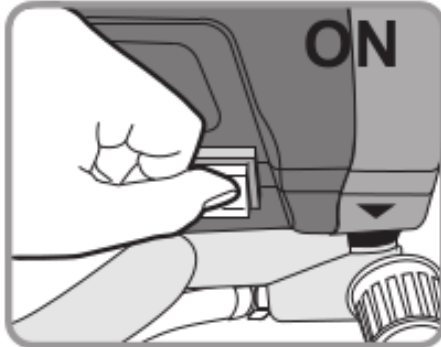

9. Once again turn on the device.



10. The paint should spread from the suction pipe through the sprayer and to the intake pipe until paint leaves the same. Point the spray gun and activate it by pressing the trigger.

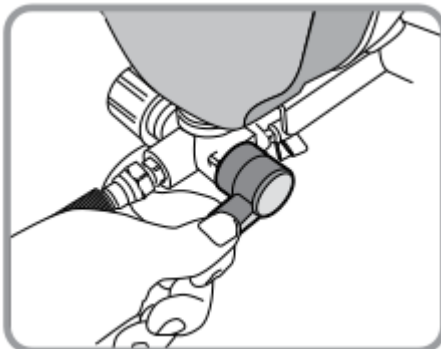

11. Set the mode selector switch to spray mode and continue spraying into the bucket.

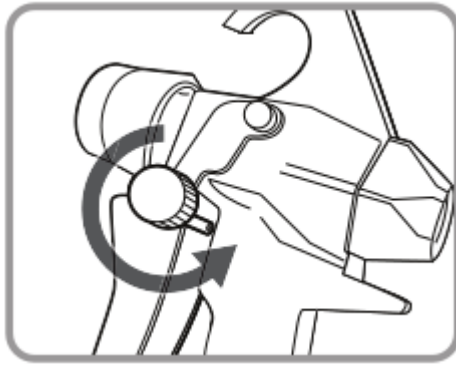

12. Stop spraying and lock the trigger with help of the release lock.

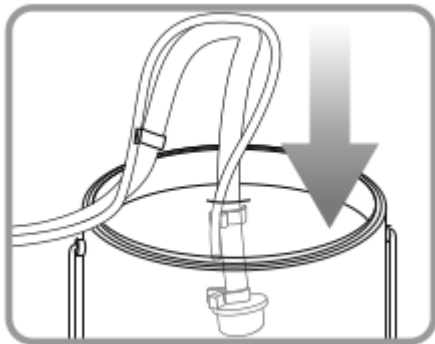

13. Remove the intake pipe from the bucket and clip it to the suction pipe. Then place both inside the paint bucket.

14. Once the pump and tubes have been primed, the motor will stop. If the motor, however, does not stop, then the priming steps must be repeated.

15. Start painting.

Painting

Before beginning the paintwork, ensure that the paint sprayer and its spray gun have been prepared according to the instructions within this operation manual.

Note: Remove or at least cover objects that you wish to protect from paint splatter and paint mist.

The distance between the spray gun and the surface you wish to paint should approximately be 30 cm.

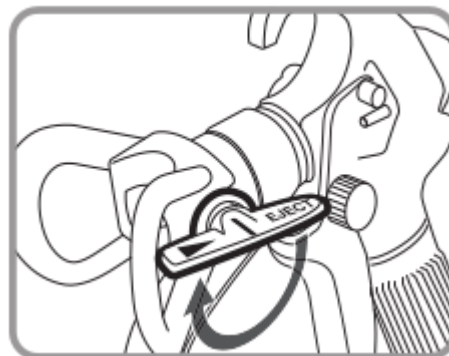

1. Once the priming process has been completed, set the nozzle to spray position.
2. Start spraying with the lowest pressure setting. If necessary, slowly increase the pressure by turning the pressure control button clockwise to create a sufficient spray pattern.

Spray techniques

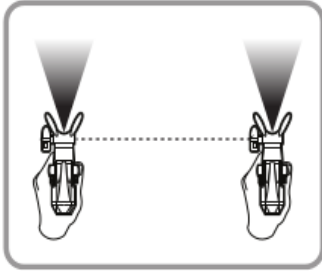

1. Hold the spray gun straight and move the arm at a constant speed while keeping approximately 30 cm to the surface.

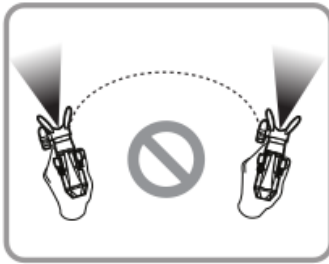

2. Do not diversify the motion of the spray gun and avoid erratic motions, since this will lead to an uneven application of paint.



Over-
lapping
lines

3. Always aim at the lower boarder of a line, to create overlapping lines.

Spray nozzle cleaning

It may occur that the nozzle of the spray gun gets obstructed by paint in the process of application. Abide by the following instructions, to successfully clean the nozzle.

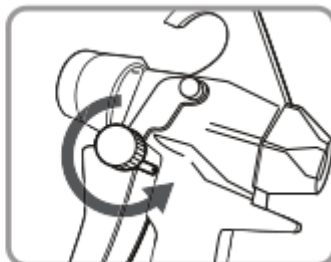
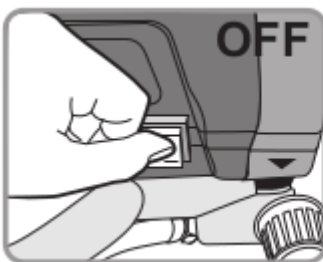

1. Turn the device off and lock the spray gun trigger by using the release lock.

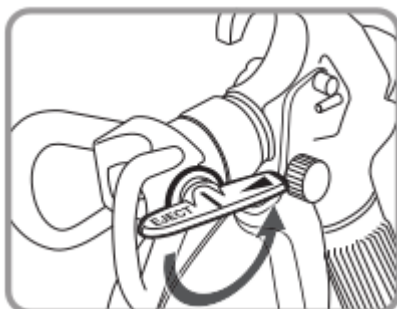

2. Set the nozzle to cleaning position.

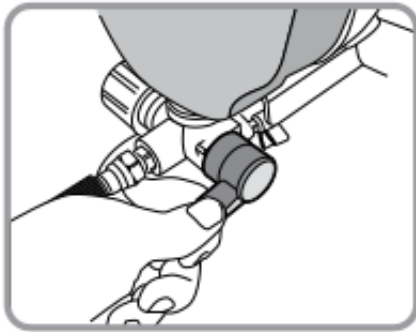

3. Set the mode control switch into spray mode.

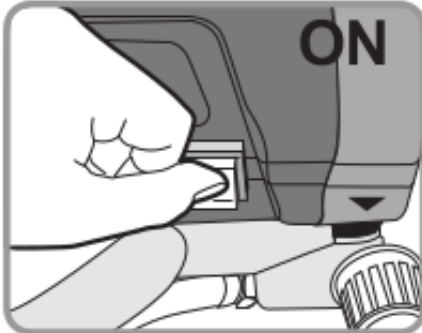

4. Once again turn the device on.

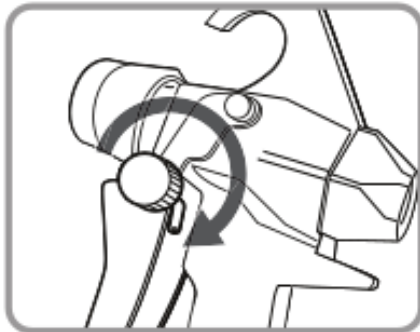

5. Unlock the trigger by releasing the release lock.



6. Spray into a bucket until the obstruction has been removed.

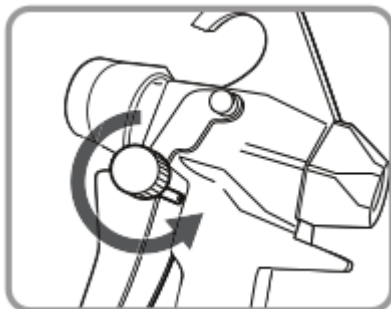

7. Let go off the trigger and once again lock it in place by activating the release lock.



8. Set the nozzle to spray position.

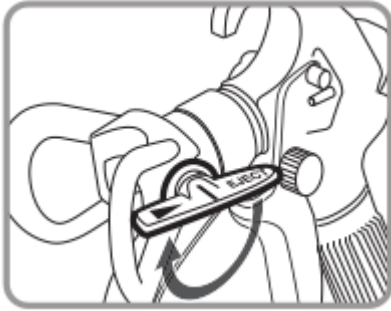

Cleaning

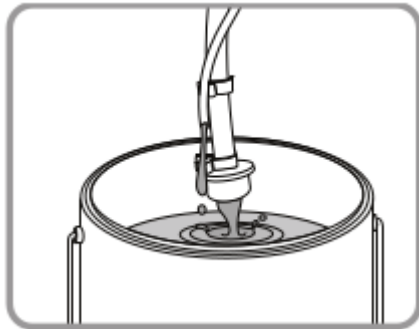

1. Release the pressure and remove the pipes of the device from the paint. Drain the remaining paint from the device by holding the pipes over the paint bucket.

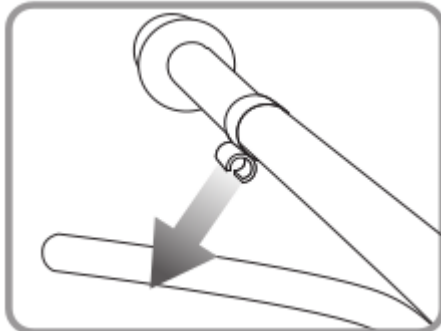

2. Separate the suction pipe and the intake pipe from each other.

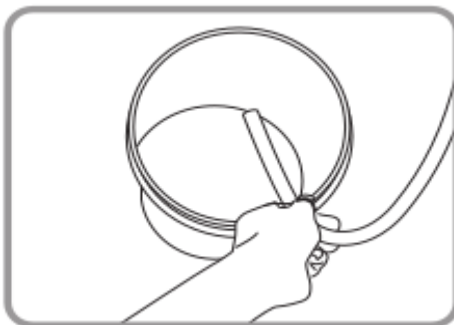

3. Place the intake pipe inside an empty bucket.

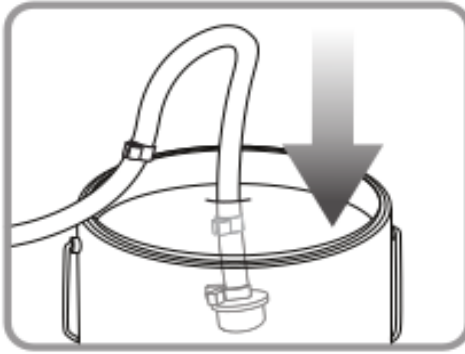

4. Place the suction pipe inside a bucket filled with water or solvent.

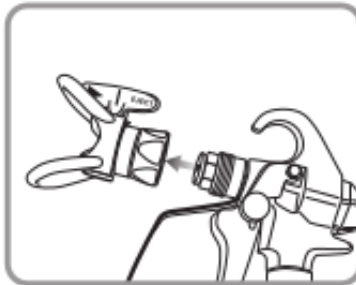
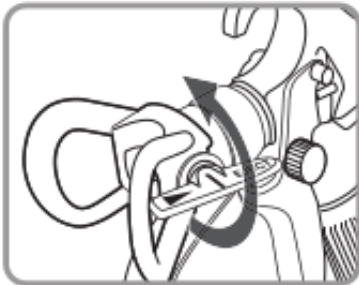

5. Carefully remove the nozzle head from the spray gun.

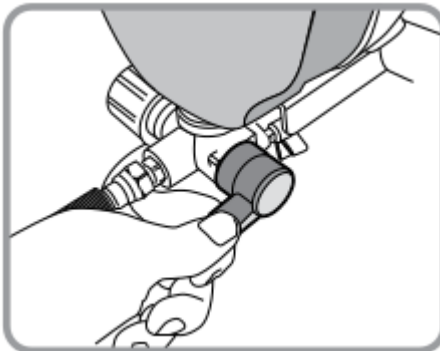

6. Set the mode selector switch to spray mode.

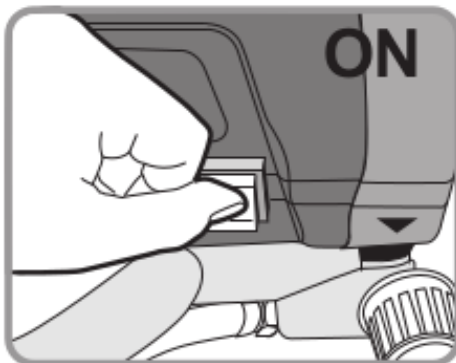

7. Turn the device on.

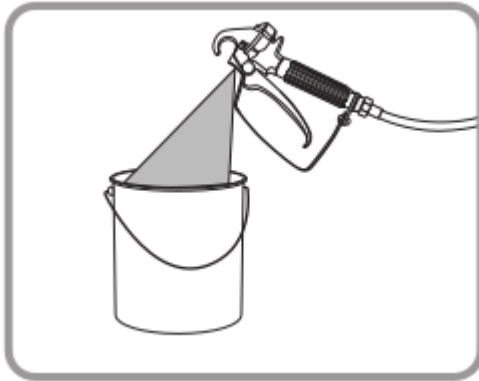

8. Spray the paint into the paint bucket.

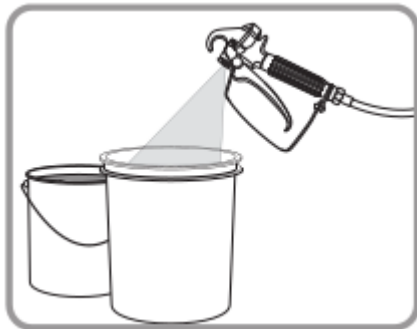

9. Switch to another bucket as soon as the paint released from the nozzle begins to thin.

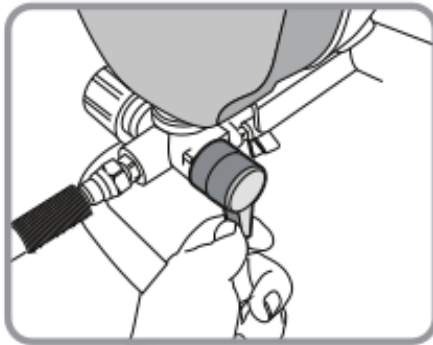

10. Change the mode selector switch setting to aspiration mode.



11. Continue to spray until the spray gun releases a clear stream.

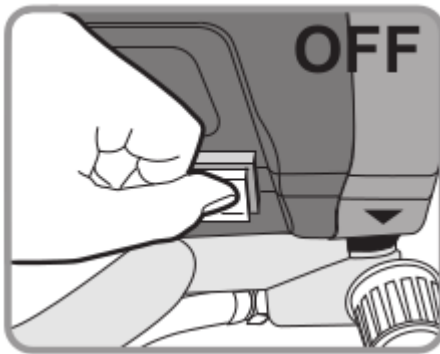

12. Release the trigger, turn the device off and release the pressure from the system.

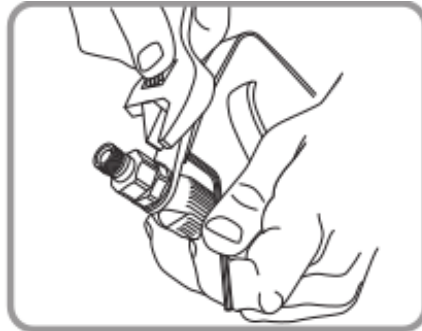

13. Remove the guard from the spray gun.

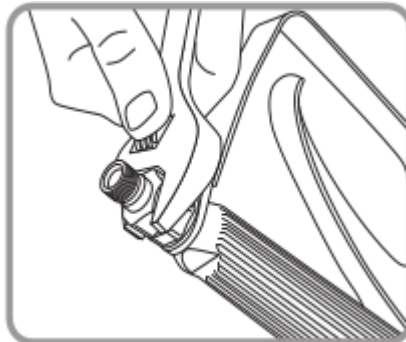

14. Remove the nut.

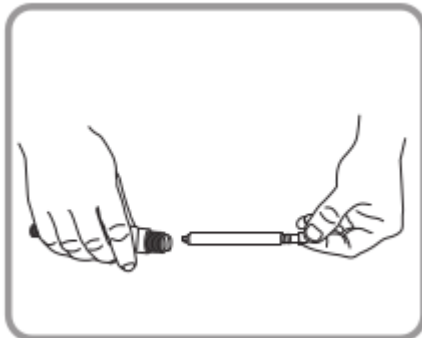

15. Remove the filter from the spray gun.

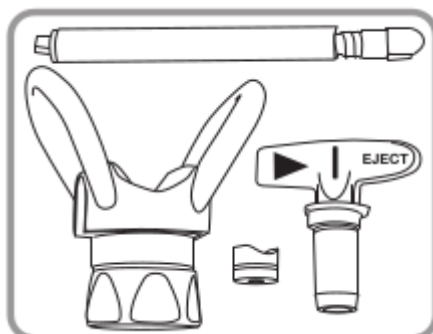

16. Thoroughly clean the parts of the spray gun with soap water or mild detergents and a brush.

Storage

- Before storing the paint sprayer for a period exceeding 48 hours, ensure that it has been cleaned thoroughly.
- It is very important that there is no residue of water or water-based substances inside the pump, spray gun, pipes, or hoses of the device as such residue can damage the same.

Important! Clean the device before storing it. To do this, check and abide by the cleaning instructions.



1. Remove the hose connecting the spray gun with the device if it has not already been removed.

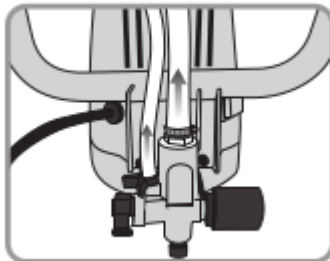

2. Place the device upside-down and remove the brackets from both pipes, before then disconnecting the same from the paint sprayer.

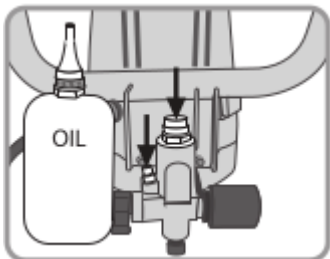

3. Insert a 1 g of mild oil or pump storage liquid into every intake.

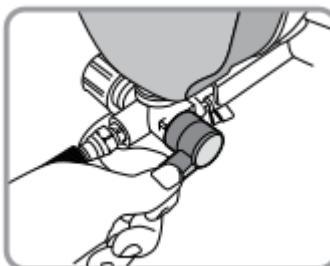

4. Set the mode selector switch to spray mode.



5. Turn the pressure control button to its lowest pressure setting.



6. Place a piece of cloth in front of the hose outlet.

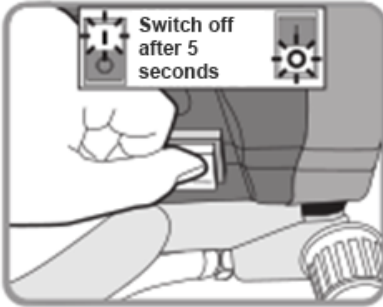

7. Turn the device on and let it run for 5 s before turning it off again.

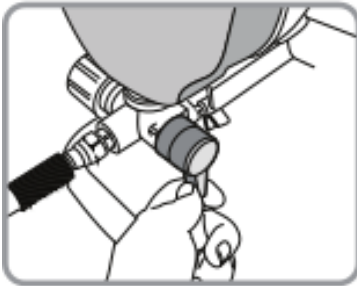

8. Set the mode selector switch to priming as this will keep the storage liquid inside the device.

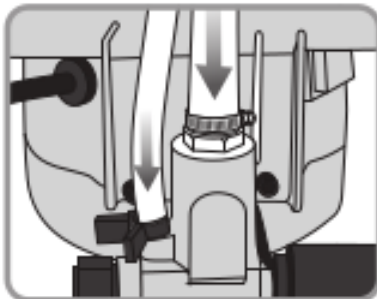

9. Reconnect the pipes and secure them with brackets.

10. Clean the paint sprayer with a clean piece of cloth and store it in a clean and dry environment. Make thereby sure that it is always inaccessible to children.



Troubleshooting

Problem	Possible Cause	Proposal for solution
Reduced performance	Obstructed trigger	Clean the trigger to make sure that it can be moved without obstruction.
Inconsistent paint stream, splashes, or stains	Damaged/clogged nozzle/filter	Clean, adjust or replace the nozzle/filter.
	Polluted paint	Remove paint from device and filter it.
Paint surface is uneven or suffers from orange peel effect	Too much paint applied	Paint must be thinned before application.
	Wrong ink volume	Adjust the liquid controller.
	Too much distance between surface and spray gun	Hold the spray gun closer to the surface.
Paint seeps	Paint too thin	Check the viscosity of the paint and thicken it if necessary.
	Too much paint applied	Apply thinner layers and allow the paint to adhere to previous layers.
	Spray gun held too close to the surface	Increase the distance between the spray gun and the surface.
	Uneven application of the paint	Keep moving the spray gun evenly during the process of application.
	Too many layers of paint	Evenly overlap layers of paint to regulate its thickness.
Blotchy surface or uneven paint application	Paint does not dry quickly enough	Use fewer diluting agents/thicken paint.
	Uneven paint application	Make sure to apply paint evenly and to overlap paths properly and equally.
	Surface does not absorb the paint evenly	Use a sealing layer.
Blotches on the surface with a light centre	Paint too thin	Use fewer diluting agents/thicken paint.
	Uneven paint application	Make sure to apply paint evenly and to overlap paths properly and equally.
	Surface does not absorb the paint evenly	Use a sealing layer.
Blotches on the surface with a dark centre	Surface dusty or dirty	Clean the surface with air pressure or a clean dust cloth.
	Surface not sanded sufficiently	Sand wood appropriately before applying paint.
	Material structure too rough	Roughen the surface with a thinner before sanding it and removing remnants sticking out from the surface.



Parts list

No	Name	Qty.	No	Name	Qty.
1	Spray gun	1	58	Bushing	1
2	Paint hose	1	59	Pole	1
3	Hex bolt (M5×10)	2	60	Handspike	1
4	Nut (M5)	2	61	Sealing washer (1)	1
5	Base frame	1	62	Sealing washer (2)	1
6	Label	1	63	Steel Sphere ø4	1
7	Tool box	1	64	Pressure relief pole	1
8	Label	1	65	Pressure relief spring	1
9	Label	1	66	Pressure relief valve	1
10	Housing cover	1	67	Spring seat	1
11	Gasket 6	2	68	Valve seat	1
12	Hex bolt (M6×35)	2	69	Spray valve	1
13	Handle	1	70	Pin (3×10)	1
14	Hand grip	1	71	O-ring (5×1.8)	2
15	Washer 4	1	72	Pin (2.5×26)	1
16	Small washer	1	73	Paint output adapter	1
17	Bolt (M4×12)	3	74	Paint output seat	1
18	PCB Support	1	75	Paint output spring	1
19	Elastic Washer 4	2	76	Steel sphere ø12.7	1
20	PCB Assembly	1	77	Paint input seat	1
21	Bolt (ST3.5×12)	2	78	O-ring (17×1.8)	1
22	Rolling bearing	1	79	Paint input seat	1
23	Bracket	1	80	Clamp 16–25	2
24	Gear bushing 9.53	2	81	Clamp 10.5	1
25	Toothed washer	1	82	Intake pipe	1
26	Gear	1	83	Suction pipe	1
27	Gear bushing 6.35	2	84	Bracket	1
28	Toothed washer	1	85	Filtrate seat assembly	1
29	Middle gear bushing	1	86	Pin 5×10	2
30	Label	1	87	Hex bolt (M5×15)	2
31	Pressure knob	1	88	Elastic washer 5	4
32	Label	1	89	Pump body	1
33	Pressure control bolt (M4×8)	1	90	Pin (3×15)	2
34	Pin A	1	91	Motor assembly	1
35	Pressure adjusting spring	1	92	Wire	1
36	Pin B	1	93	Terminal clamp	1



No	Name	Qty.	No	Name	Qty.
37	Pressure control pin	1	94	HY12 Power switch	1
38	O-ring (2×1.2)	2	95	Wire connector	1
39	Lock nut	1	96	Power cord	1
40	Hex bolt (M3×10)	2	97	Elastic washer	3
41	Pressure adjusting valve	1	98	Bolt (M5×10)	3
42	O-ring (8.8×1.8)	1	99	Label	1
43	O-ring (27×2.4)	1	100	Housing	1
44	Micro switch	1	101	Label	1
45	Micro switch cover	1	102	Label	1
46	Hose outlet	1	103	Piston	1
47	O-ring (10×1.8)	1	104	Copper guide bushing	1
48	Output spring	1	105	O-Ring (26.5×1.8)	1
49	Thread pin	1	106	Connector	1
50	Steel sphere (ø6.35)	1	107	Oil ring	1
51	Seal seat	1	108	Washer	1
52	Pusher	1	109	Sealing ring	2
53	Shield	1	110	O-ring (14×2.65)	2
54	O-ring (2.6×1.8)	1	111	Sealing ring	1
55	Sealing ring	1	112	O-ring (22.4×1.8)	1
56	Seal washer	1	113	Copper guide bushing	1
57	Spring	1			

Technical specifications

Voltage (V)	230
Frequency (Hz)	50–60
Motor power (W)	600
Max. amount of liquid (m³/min)	1100
Paint temperature (°C)	5–40
Length of paint hose (m)	10
Length of air hose (m)	7.5
Length of suction hose (m)	1
Length of cable (m)	2
Nozzle diameter (mm)	0.19
Working pressure (bar)	103–151 (1500–2200 psi)
Max. air hose pressure (MPa)	7.5
Max. spray gun pressure (bar)	248 (3600 psi)
Noise level (dB (A))	< 90
Weight (kg)	7.5

Exploded view

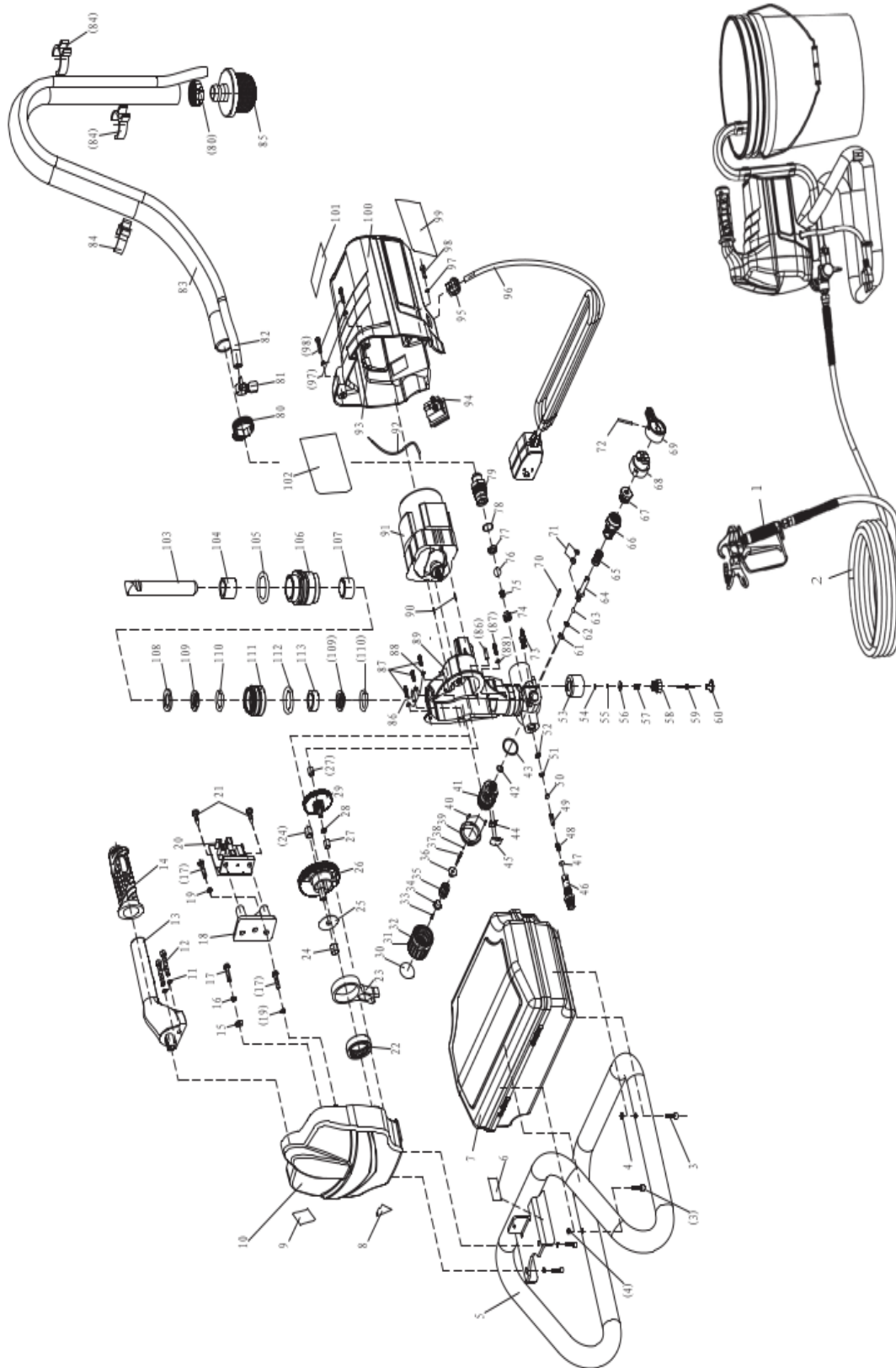

Disposal regulations

EU guidelines regarding the disposal of scrap electric appliances (WEEE, 2012/19/EU) were implemented in the law related to electrical and electronic equipment and appliances.

All WiTec electric devices that fall under the WEEE regulations are labelled with the crossed-out wheeled waste bin logo. This logo indicates that this electric equipment must not be disposed with the domestic waste.

The company WiTec Technik GmbH has been registered in the German registry EAR under the WEEE-registration number DE45283704.

Disposal of used electrical and electronic appliances (intended for use in the countries of the European Union and other European countries with a separate collection system for these appliances).

The logo on the article or on its packaging points out that this article must not be treated as normal household waste but must be disposed to a recycling collection point for electronic and electrical waste equipment. By contributing to the correct disposal of this article you protect the environment and the health of your fellow men. Environment and health are threatened by inappropriate disposal.



Material recycling helps reduce the consumption of raw materials.

Additional information on recycling this article can be provided by your local community, municipal waste disposal facilities, or the store where you purchased the article.

Address:
WiTec Wildanger Technik GmbH
Königsbenden 12 / 28
D-52249 Eschweiler

Important notice:

The reprint or reproduction, even of excerpts, and any commercial use, even in part, of this instruction manual require the written permission of WiTec Wildanger Technik GmbH.