

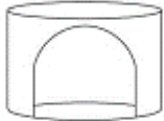















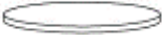













## 62941 + 62492 – Krabpaal

 ① 65x60cm*1	 ② 45*35*30cm*3	 ③ 65x60cm*1
 ④ $\varnothing$ 40cm*3	 ⑤ 45x35cm*2	 ⑥ 45x35cm*3
 ⑦ 45*35cm*3	 ⑧ 30x30cm*2	 ⑨ 45x35cm*2
 ⑩ $\varnothing$ 30cm*1	 ⑪ 56x14cm*2	 ⑫ 48x14cm*2
 ⑬ M8x37x7cm*1	 ⑭ 7x37cm*1	 ⑮ 50cm*1
 ⑯ 27cm*4	 ⑰ 27cm*6	 ⑱ 30cm*2
 ⑲ 40cm*4	 ⑳ 31cm*2	 ㉑ 24cm*1
 ㉒ 28cm*2	 ㉓ 25cm*2	 ㉔ 20cm*3
 ㉕ 38cm*1	 ㉖ 11cm*4	 ㉗ M8x40*17
 ㉘ M8x80*22	 ㉙ *1	 ㉚ M8x20*4
		 ㉛ M8*1

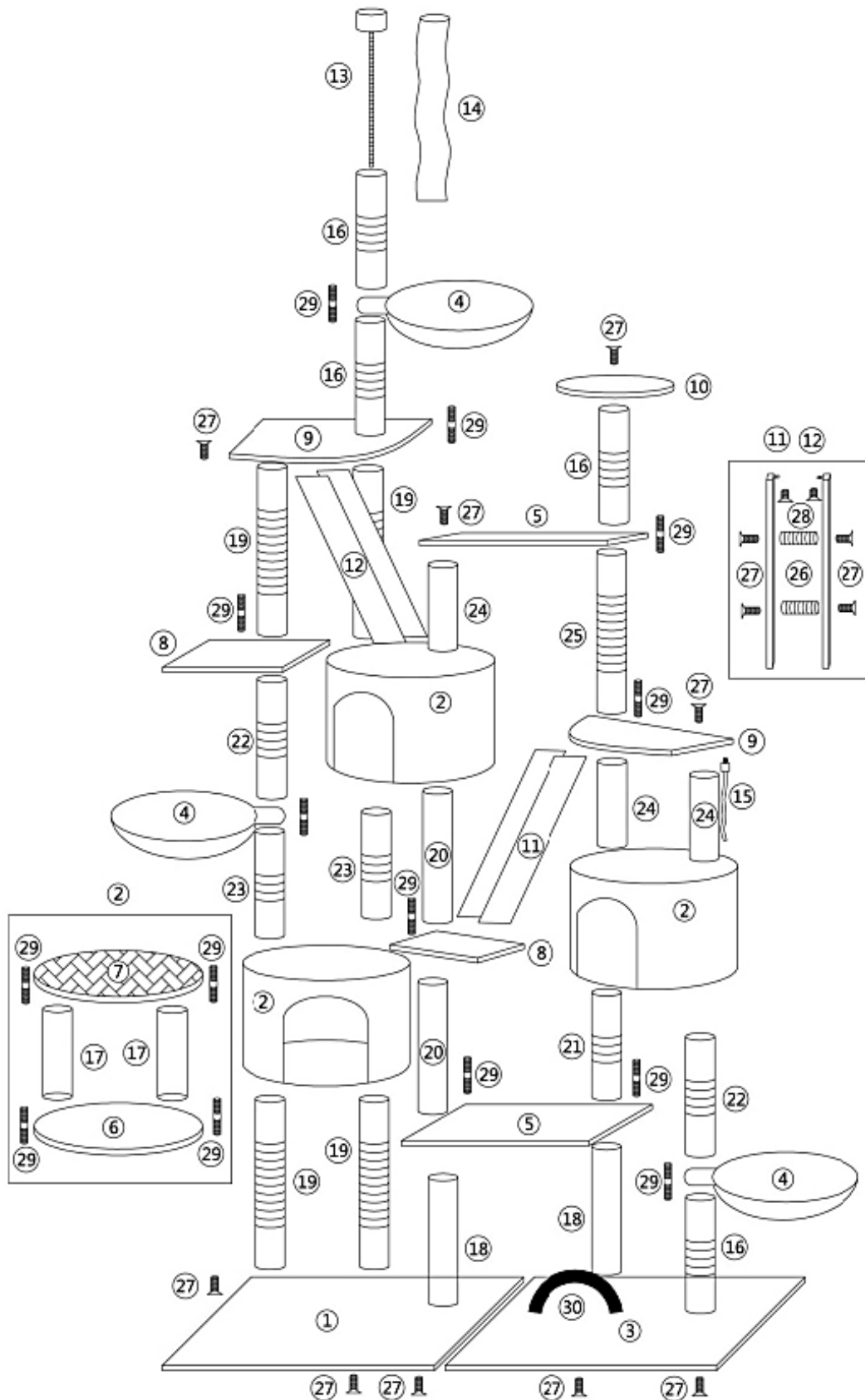

**Belangrijk:** Het op welke manier kopiëren van deze handleiding en/of gebruik ervan voor commerciële doeleinden, is alleen toegestaan met schriftelijke toestemming van WilTec Wildanger Technik GmbH vooraf.