

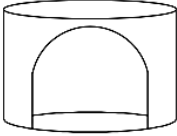











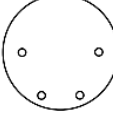
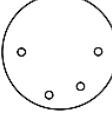
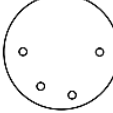
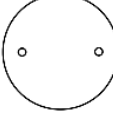

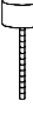





# AUFBAUANLEITUNG

## 63241–63242 – Kratzbaum

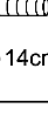
 ① 70x40cm*1	 ② 40*40*30cm*3	 ③ 30x30cm*1
 ④ ø30cm*3	 ⑤ 29x29cm*1	 ⑥ ø40cm*1
 ⑦ ø40cm*1	 ⑧ ø40cm*1	 ⑨ ø40cm*3
 ⑩ 7x37cm*1	 ⑪ M8x37x7cm*1	 ⑫ 50cm*2
 ⑬ 52cm*1	 ⑭ 52cm*1	 ⑮ 27cm*6
 ⑯ 49cm*2	 ⑰ 49cm*2	 ⑱ 40cm*8
 ⑲ 27cm*1	 ⑳ 28cm*2	 ㉑ 22cm*1
 ㉒ 14cm*6	 ㉓ M8x40*17	 ㉔ M8x20*6
 ㉕ M8x80*15	 ㉖ M8*1	

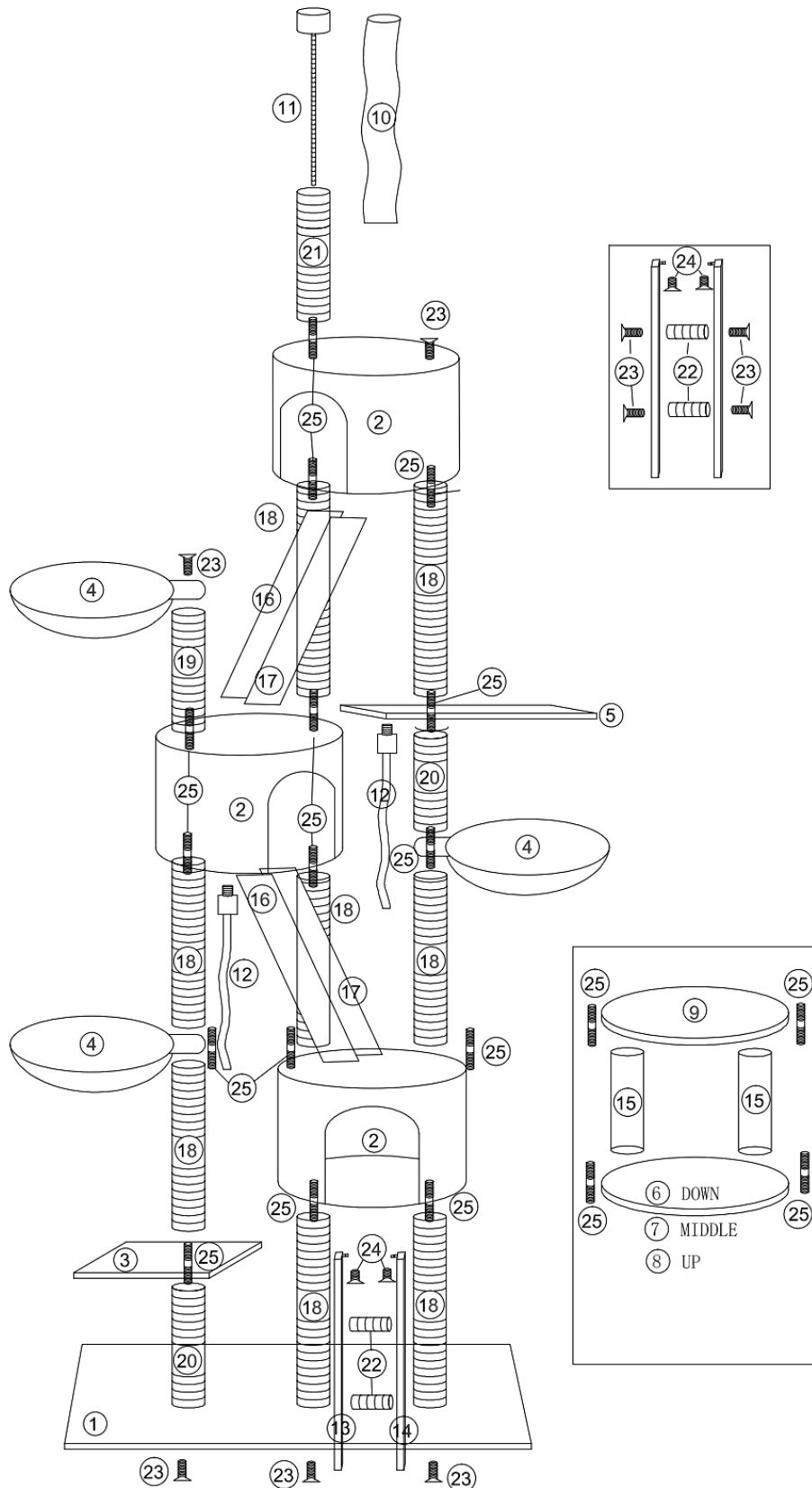

**Wichtiger Hinweis:** Nachdruck, auch auszugsweise, und jegliche kommerzielle Nutzung, auch von Teilen der Anleitung, nur mit schriftlicher Genehmigung, der WilTec Wildanger Technik GmbH.