

# Operation Manual

## Wet and Dry Vacuum Cleaner

63113

**XPO** <sup>the</sup> **tool**  
experts



Illustration similar, may vary depending on model

Read and follow the operating instructions and safety information before using for the first time.

Technical changes reserved!

Due to further developments, illustrations, functioning steps, and technical data can differ insignificantly.

Updating the documentation

If you have suggestions for improvement or have found any irregularities, please contact us.



The information contained in this document may alter at any time without previous notice. It is prohibited to copy or spread any parts of this document in any way without prior written allowance. All rights reserved.

The WilTec Wildanger Technik GmbH cannot be held accountable for any possible mistakes in this operating manual, nor in the diagrams and figures shown.

Even though, the WilTec Wildanger Technik GmbH has undergone biggest possible efforts to ensure that the operating manual is complete, faultless, and up to date, mistakes cannot be entirely avoided.

If you should find a mistake or wish to make a suggestion for improvement, we look forward to hearing from you.

Send an e-mail to:

[service@wiltec.info](mailto:service@wiltec.info)

or use our contact form:

<https://www.wiltec.de/contacts/>

The most recent version of this manual in various languages can be found in our online shop via:

<https://www.wiltec.de/docsearch>

Our postal address is:

WilTec Wildanger Technik GmbH  
Königsbenden 12  
52249 Eschweiler  
Germany

To return orders for exchange, repair, or other purposes, please use the following address. Attention! To allow for a smooth execution of your complaint or return, it is important to contact our customer service team before returning the goods.

Returns Department  
WilTec Wildanger Technik GmbH  
Königsbenden 28  
52249 Eschweiler

E-mail: **service@wiltec.info**

Tel: +49 2403 55592-0

Fax: +49 2403 55592-15

## Introduction

Thank you for purchasing this quality product. **To minimise the risk of injury we urge that our clients take some basic safety precautions when using this device. Please read the operation instructions carefully and make sure you have understood its content.** Keep these operation instructions safe.

## Features

- Powerful and compact
- Suitable for wet and dry vacuuming
- Multiple air filter system ensures hygienic cleaning
- With special air blow function
- Can also be used in ponds
- With special parking aid for easy and space-saving parking
- Air flow control on handle
- Easy moving and pulling thanks to rotating wheels
- Various attachments
- User-friendly design

## Main components and accessories



8



9



10



11



12



13

Nº	Name	Nº	Name
1	Cover	8	Discharge hose
2	Hook	9	Plastic tubes
3	Container	10	Wet brush
4	Wheel	11	Pond brush
5	Hose handle	12	Nozzle
6	Hose	13	Filter bag
7	On/off switch		



## Important safety instructions

- A defective power cable must be replaced by a qualified electrician.
- The device must not be used by persons (including children) with limited physical, sensory, or mental capabilities or a lack of experience and knowledge, unless they are supervised or have been instructed by a person responsible for their safety about the correct use of the device. Children must be supervised to ensure that they do not play with the device.
- Do not vacuum any sharp-edged, hot, or glowing materials.
- Do not expose the device to heat.
- Unplug the device after use and before cleaning. Do not pull the plug out of the socket by the power cord.
- Do not insert anything into the openings. Do not use the vacuum cleaner if its openings are blocked. Keep them free of dust, lint, hair, etc.
- Do not use the vacuum cleaner without a dust container or dust filter.
- Do not vacuum flour, cement, etc. to avoid overloading the vacuum cleaner.
- Only wipe the device clean with a dry or damp cloth. Never immerse it in water. Do not use solvents for cleaning.
- This device is only intended for household use, not for commercial applications.
- Do not touch furniture surfaces with the nozzle or brush.
- Do not carry the device by the power cord. Keep the power cord away from sharp edges.

## Assembly

### 1. Dust filter:

Carefully insert the dust filter into the dust container.

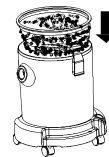

### 2. Dust container:

Attach the dust container to the vacuum cleaner.

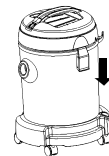

### 3. Flexible hose (optional):

To use the flexible hose, insert the end of the hose into the suction hole. Make sure that it clicks into place.

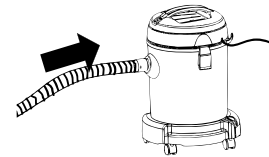

### 4. Accessories:

Select an accessory (brush or nozzle) and attach it to the suction hole.

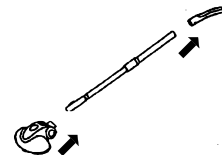

### 5. Outlet hose:

Take the outlet hose and attach it (with the rubberless end) to the outlet hole.

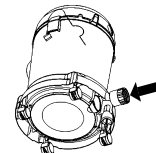

### 6. Filter bag:

Attach the filter bag to the outlet tube.

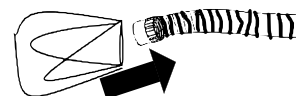

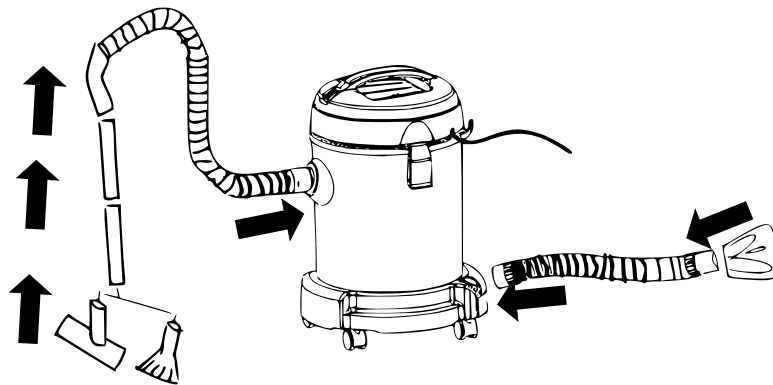

## Operation

1. Before starting the device, make sure that the dust filter is in place.

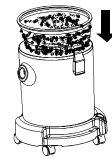

2. Unwind the power cord completely.

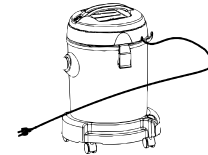

3. Plug in the plug and switch on the device.

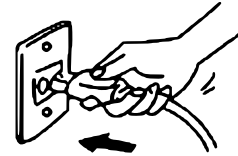

4. After use, pull the plug out again.

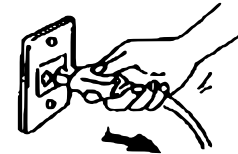

5. Set the switch to "I" to use the vacuum cleaner as a wet or dry vacuum cleaner. Set the switch to "II" to use it as a pond cleaner (automatic drainage of water). Set the switch to "O" to switch the vacuum cleaner off again.

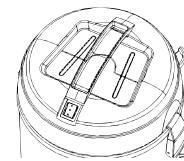

6. Connect the appropriate accessory.

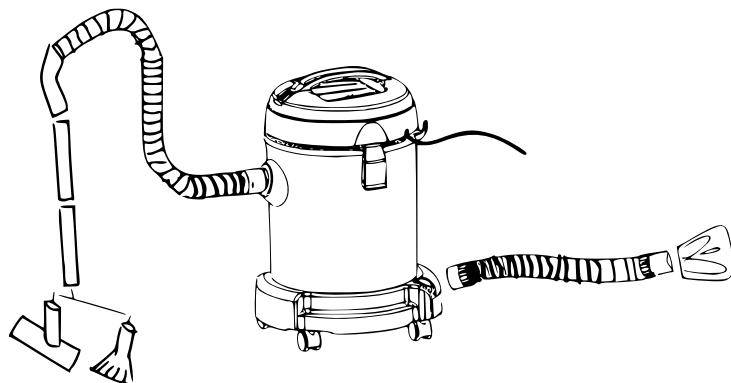

## Cleaning and maintaining

1. Open the dust container.

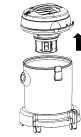

2. Remove the dust filter.



3. Empty the container.



4. Wash the dust filter with clean water.



5. Let the dust filter dry.



6. Re-assemble the vacuum cleaner.



## Troubleshooting

Problem	Possible cause	Solution
Motor does not start.	Cable not firmly plugged in	Firmly plug in cable.
	Socket damaged	Check socket.
	Vacuum cleaner not switched on	Switch on vacuum cleaner.
Weakening suction power	Blockages	Remove blockages.
	Dust filter dirty	Clean dust filter.
	Dust filter not connected	Connect dust filter.
	Filter clogged	Clean filter.

## Technical specifications

<b>Rated voltage (V)</b>	2230 AC
<b>Rated frequency (Hz)</b>	50
<b>Power (W)</b>	1200
<b>Operation pressure (kPa)</b>	≥20 (0.2 bar)
<b>Rage (m)</b>	9

### Scope of delivery

- 1 × pond vacuum cleaner
- 1 × suction tube (4 pieces)
- 1 × drain hose
- 1 × suction hose
- 1 × pond brush
- 1 × floor nozzle
- 1 × crevice nozzle
- 1 × sponge filter
- 1 × grid filter
- 1 × fleece bag filter
- 4 × wheels

### Wiring diagram

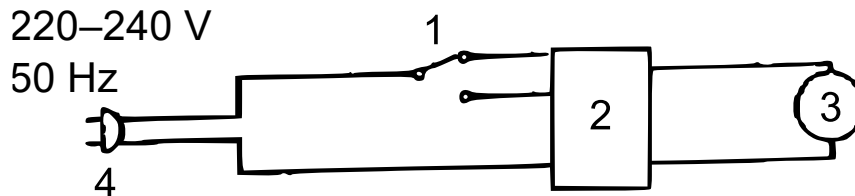

No	Name	No	Name
1	Switch	3	Motor
2	PCB	4	Mains plug

## Disposal regulations

EU guidelines regarding the disposal of scrap electric appliances (WEEE, 2012/19/EU) were implemented in the law related to electrical and electronic equipment and appliances.

All WiITec electric devices that fall under the WEEE regulations are labelled with the crossed-out wheeled waste bin logo. This logo indicates that this electric equipment must not be disposed with the domestic waste.

The company WiITec Technik GmbH has been registered in the German registry EAR under the WEEE-registration number DE45283704.

Disposal of used electrical and electronic appliances (intended for use in the countries of the European Union and other European countries with a separate collection system for these appliances).

The logo on the article or on its packaging points out that this article must not be treated as normal household waste but must be disposed to a recycling collection point for electronic and electrical waste equipment. By contributing to the correct disposal of this article you protect the environment and the health of your fellow men. Environment and health are threatened by inappropriate disposal.



Material recycling helps reduce the consumption of raw materials.

Additional information on recycling this article can be provided by your local community, municipal waste disposal facilities, or the store where you purchased the article.

Address:  
WiITec Wildanger Technik GmbH  
Königsbenden 12 / 28  
D-52249 Eschweiler

### Important notice:

The reprint or reproduction, even of excerpts, and any commercial use, even in part, of this instruction manual require the written permission of WiITec Wildanger Technik GmbH.