















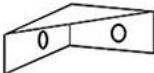
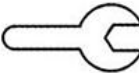

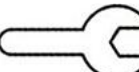





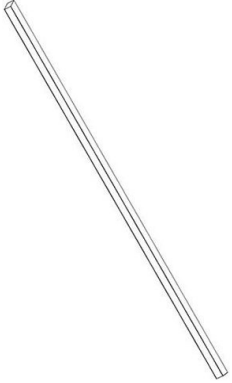

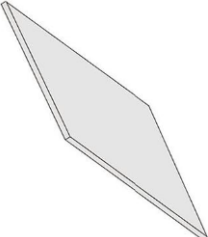

Tornillos y accesorios							
Letra	Fig.	Dim. (mm)	Uds.	Letra	Fig.	Denomin.	Uds.
A		M8×40	16	G		Pie	8
B		M8×35	76	H		Llave Allen M6	1
C		Conector de 90°	16	I		Llave Allen M8	1
D		Pieza angular	4	J		Llave M6	1
E		M8×16	8	K		Llave M8	1
F		M8×45	4	L		Tuerca	72

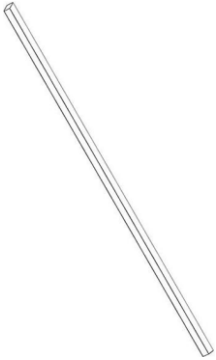
Componentes								
Nº	Fig.	Uds.	Nº	Fig.	Uds.	Nº	Fig.	Uds.
1		2	6		2	11		2
	650 × 25 × 25			1250 × 25 × 25			805 × 20 × 10	
2		2	7		2	12		3
	1710 × 25 × 25			1250 × 25 × 25				

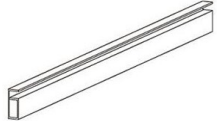

3		4	8		2	13	 Back cloth Pañuelo trasero	1
	1410 × 25 × 25			1250 × 25 × 25				
4		2	9		2	14	 Front cloth Pañuelo delantero	1
	1835 × 25 × 25			1300 × 30 × 10				
5		2	10		2			
	650 × 25 × 25			825 × 30 × 10				

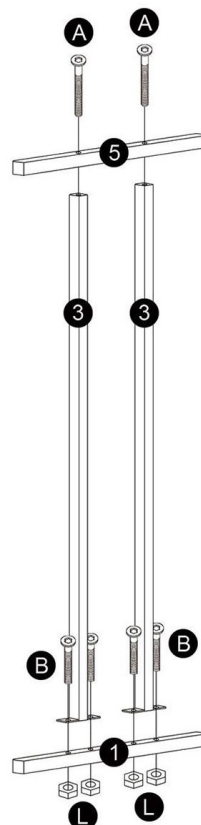
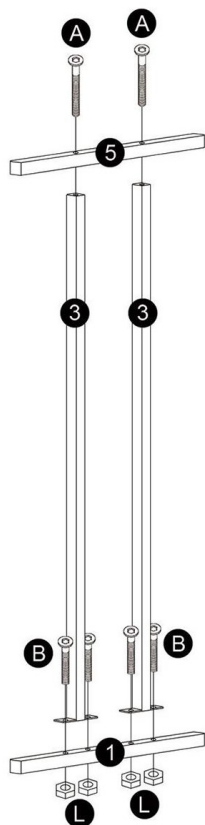

Paso 1

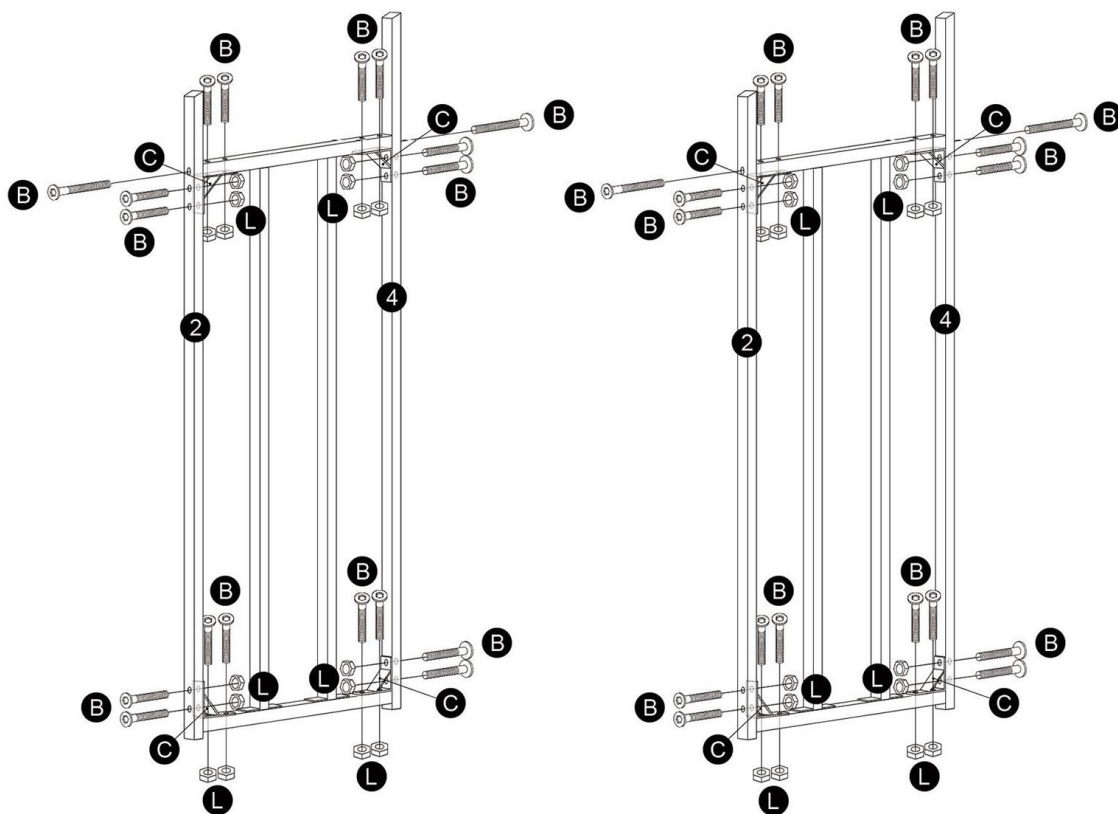

Paso 2

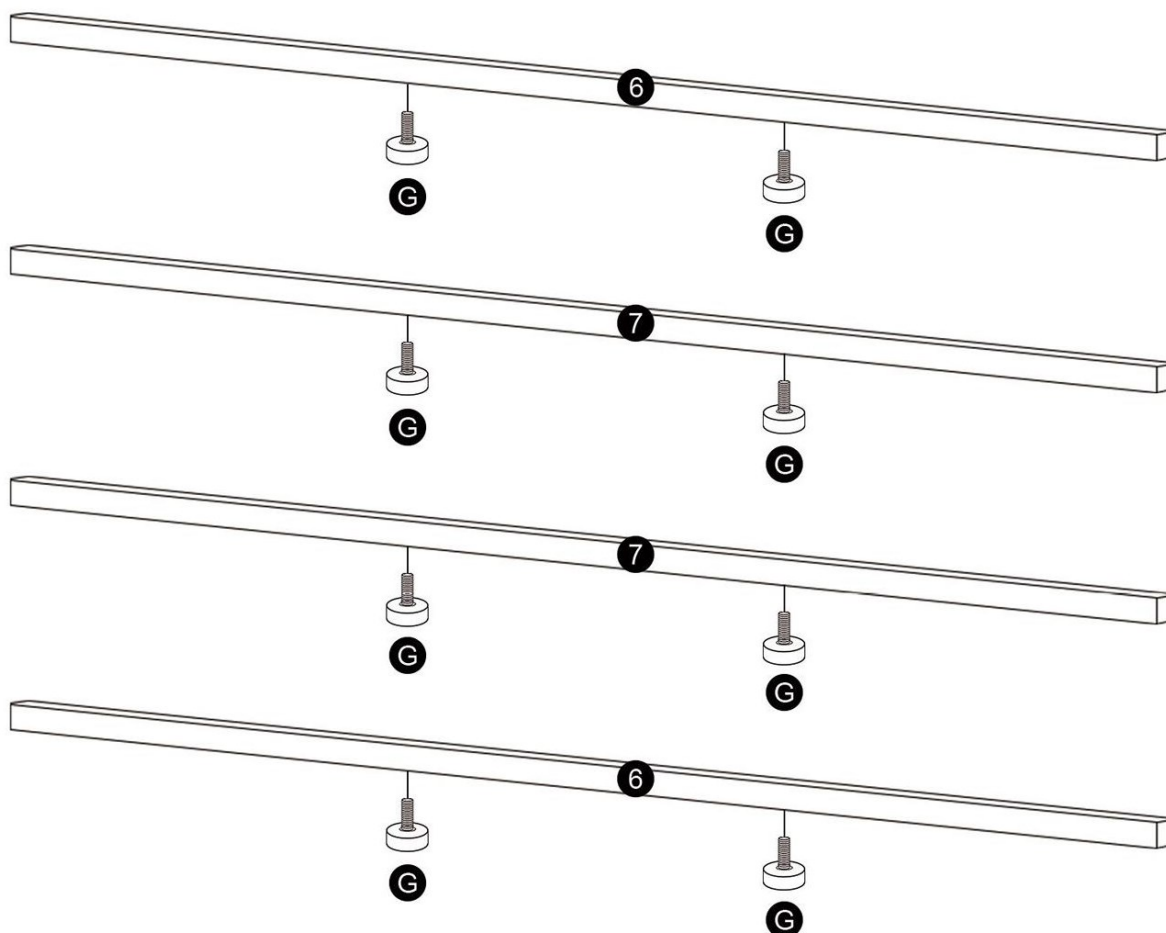

Paso 3

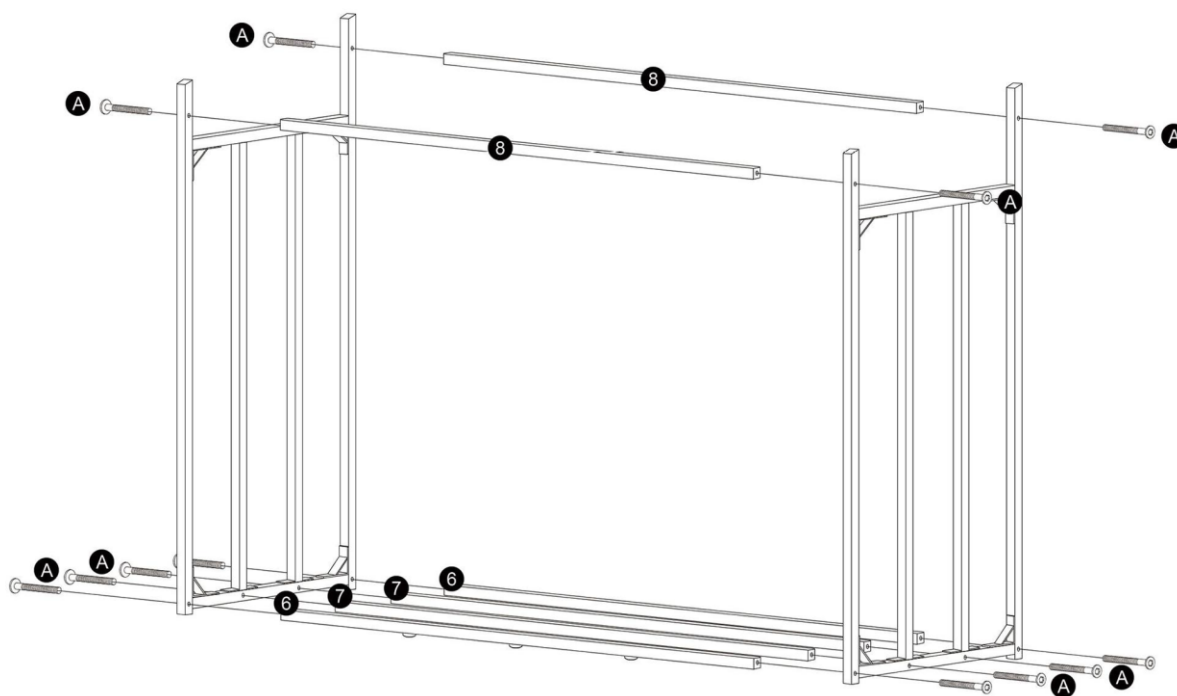

Paso 4

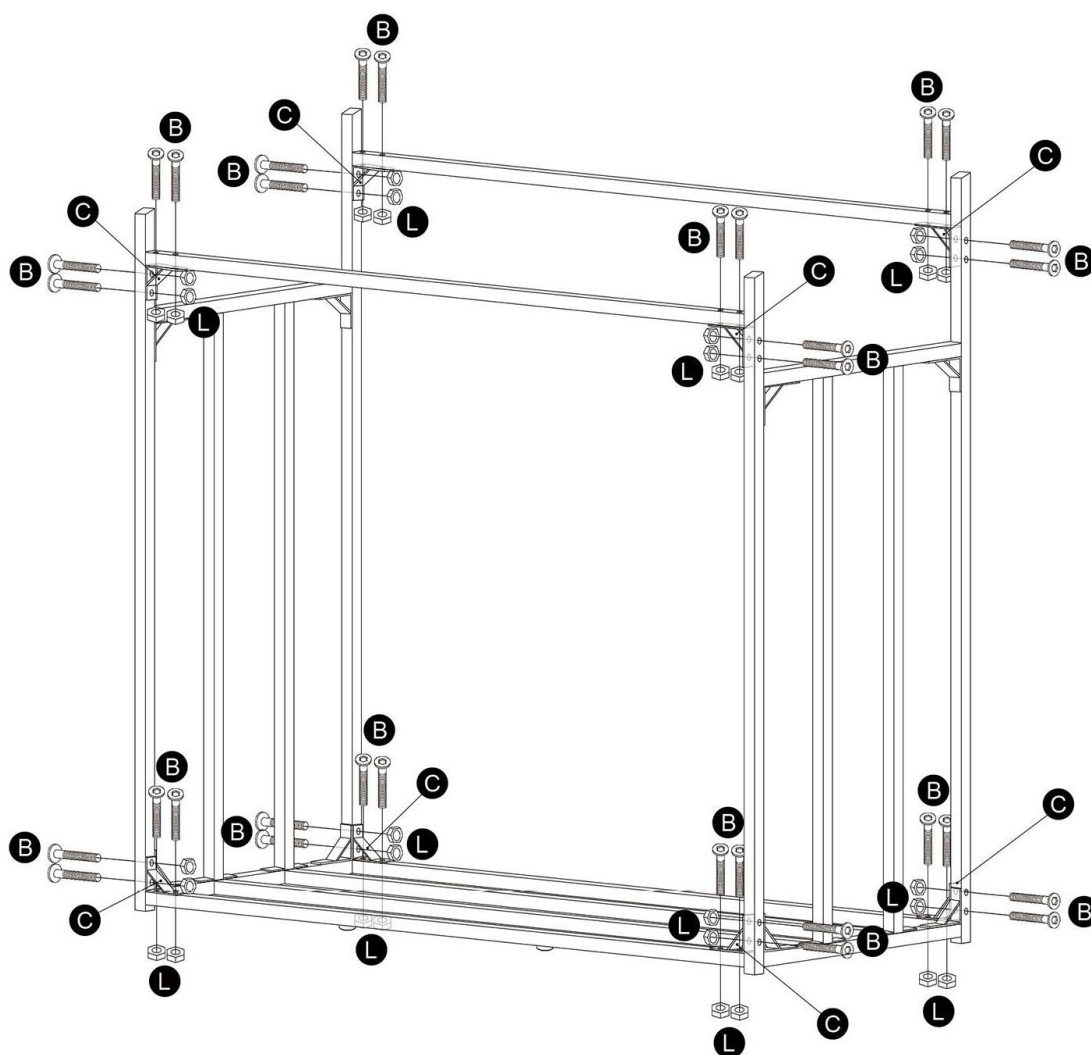

Paso 5

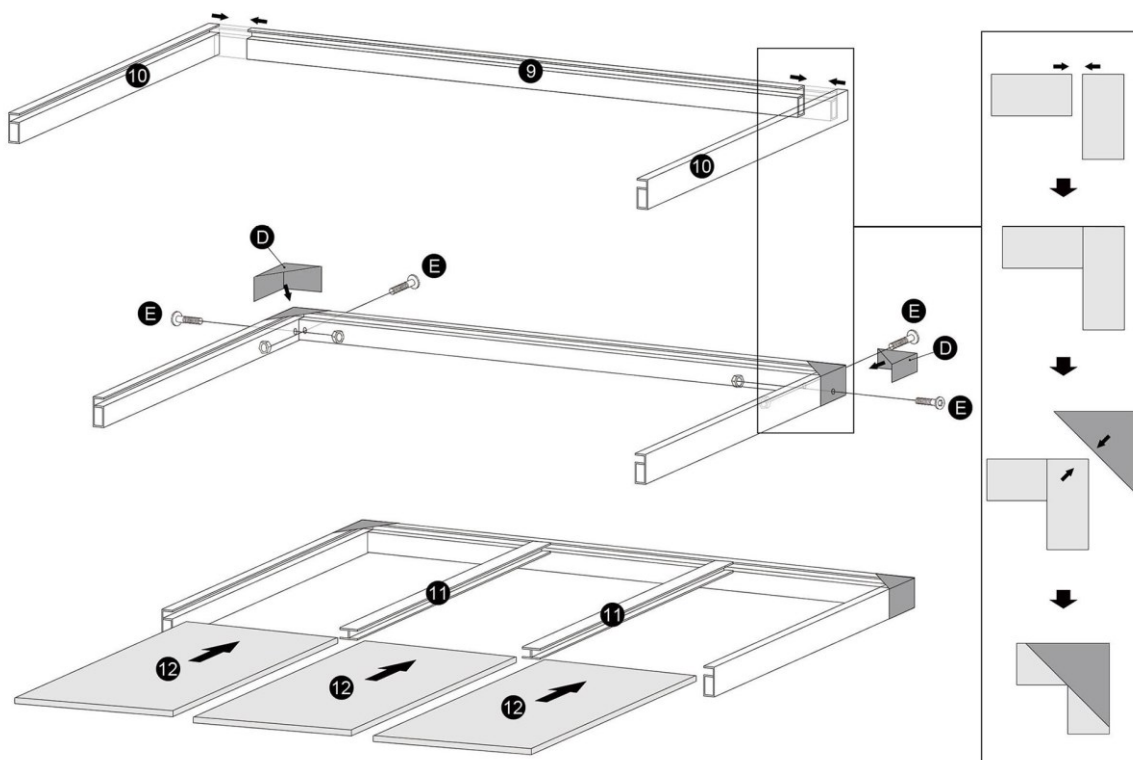

Paso 6

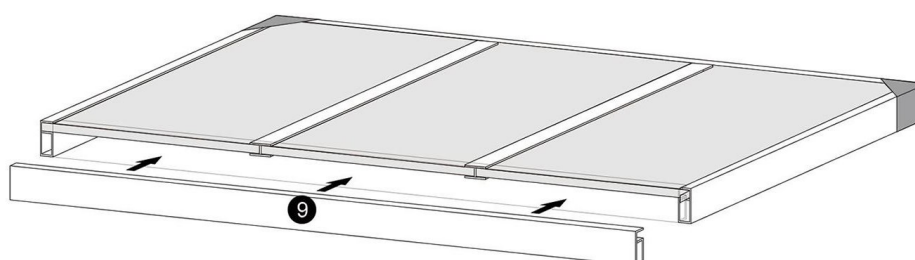

Paso 7

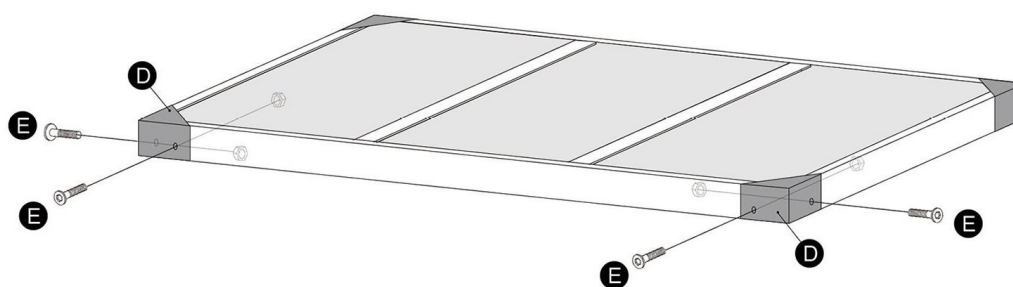

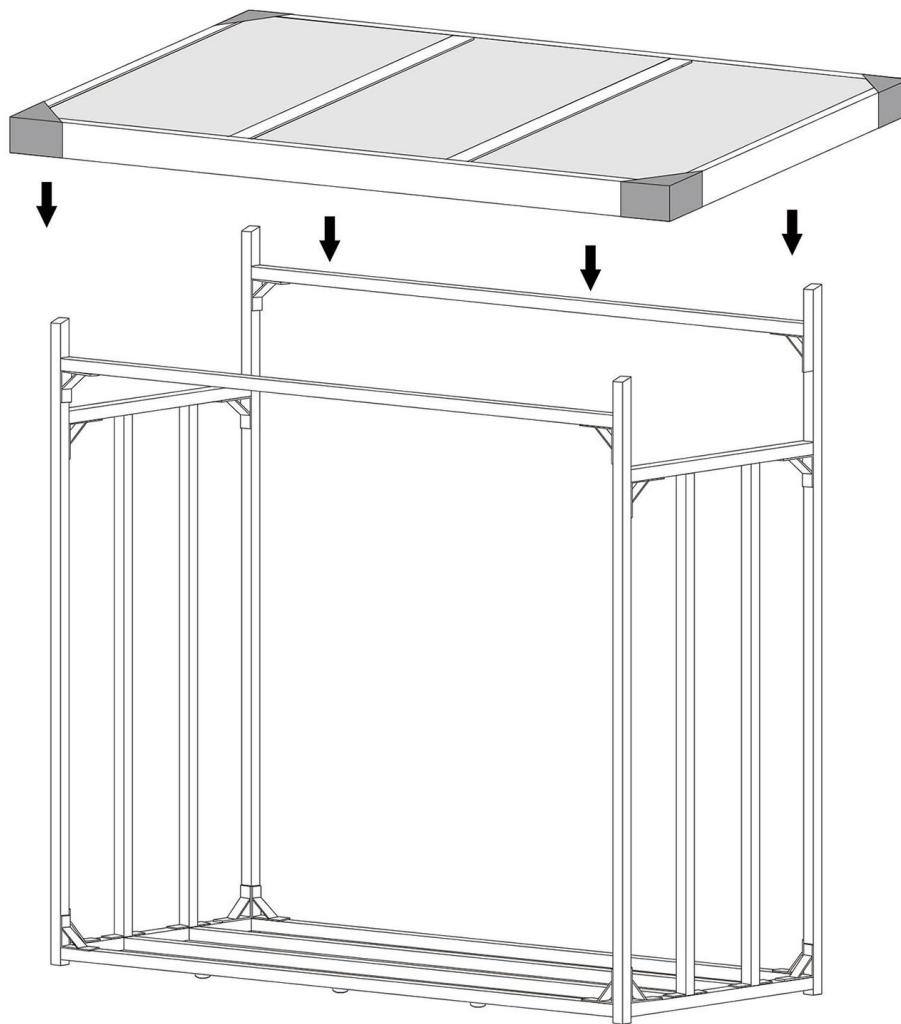

Paso 8

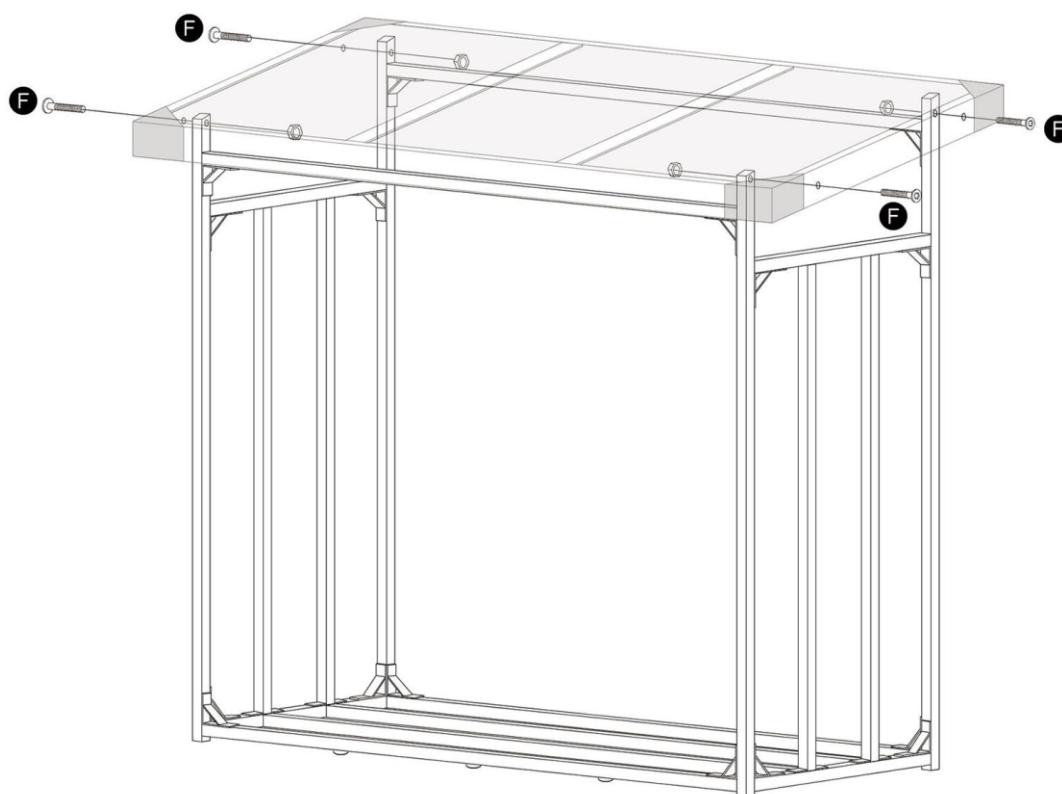

Paso 9

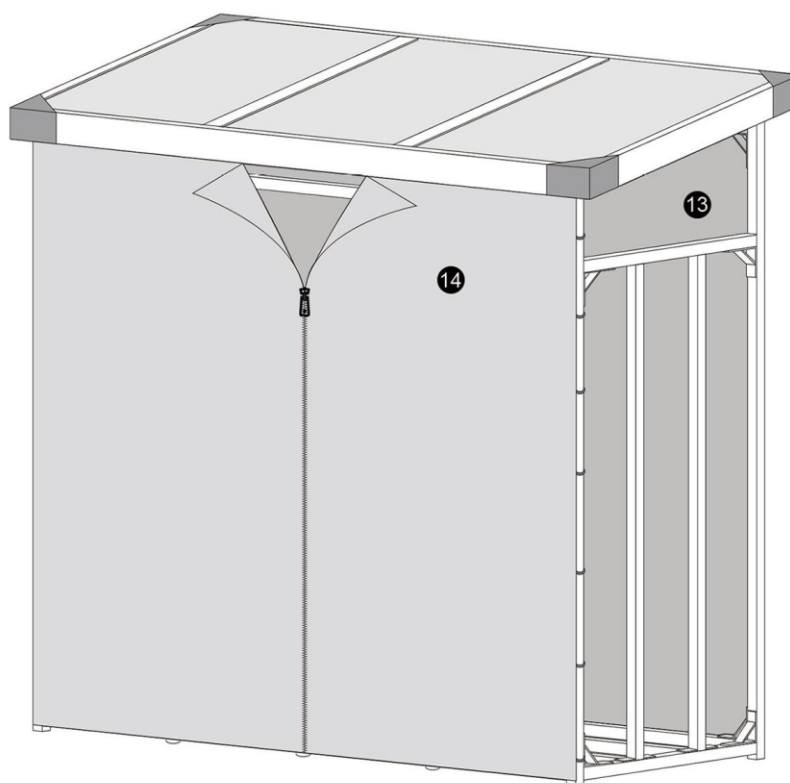

Paso 10

**Aviso importante:** La reimpresión de este manual, también parcial, así como cualquier uso comercial, incluso de algunas de sus partes, solo con autorización por escrito de la empresa WilTec Wildanger Technik GmbH.