















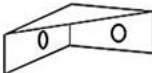
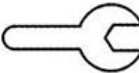

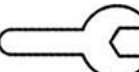

Viti e accessori							
Lettera	Fig.	Dim. (mm)	Qtà	Lettera	Fig.	Denomin.	Qtà
A		M8×40	16	G		Base	8
B		M8×35	76	H		Brugola M6	1
C		Giunto di 90°	16	I		Brugola M8	1
D		Pezzo d'angolo	4	J		Chiave M6	1
E		M8×16	8	K		Chiave M8	1
F		M8×45	4	L		Dado	72

Componenti								
Nº	Fig.	Qtà	Nº	Fig.	Qtà	Nº	Fig.	Qtà
1		2	6		2	11		2
	650 × 25 × 25			1250 × 25 × 25			805 × 20 × 10	
2		2	7		2	12		3
	1710 × 25 × 25			1250 × 25 × 25				

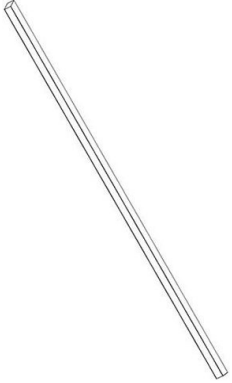

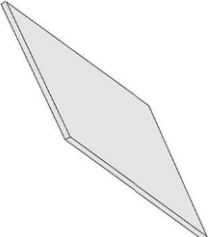
3		4	8		2	13	 Back cloth Panno posteriore	1
	1410 × 25 × 25			1250 × 25 × 25				
4		2	9		2	14	 Front cloth Panno davanti	1
	1835 × 25 × 25			1300 × 30 × 10				
5		2	10		2			
	650 × 25 × 25			825 × 30 × 10				

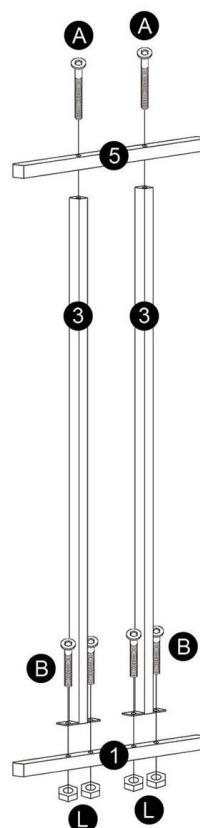
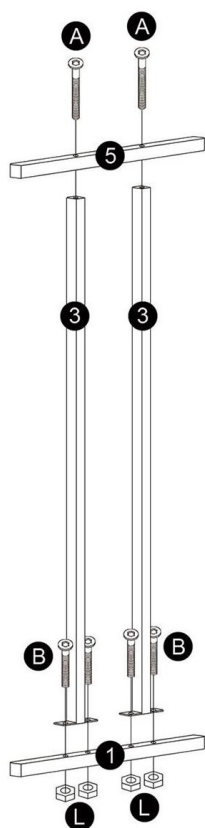

Passaggio 1

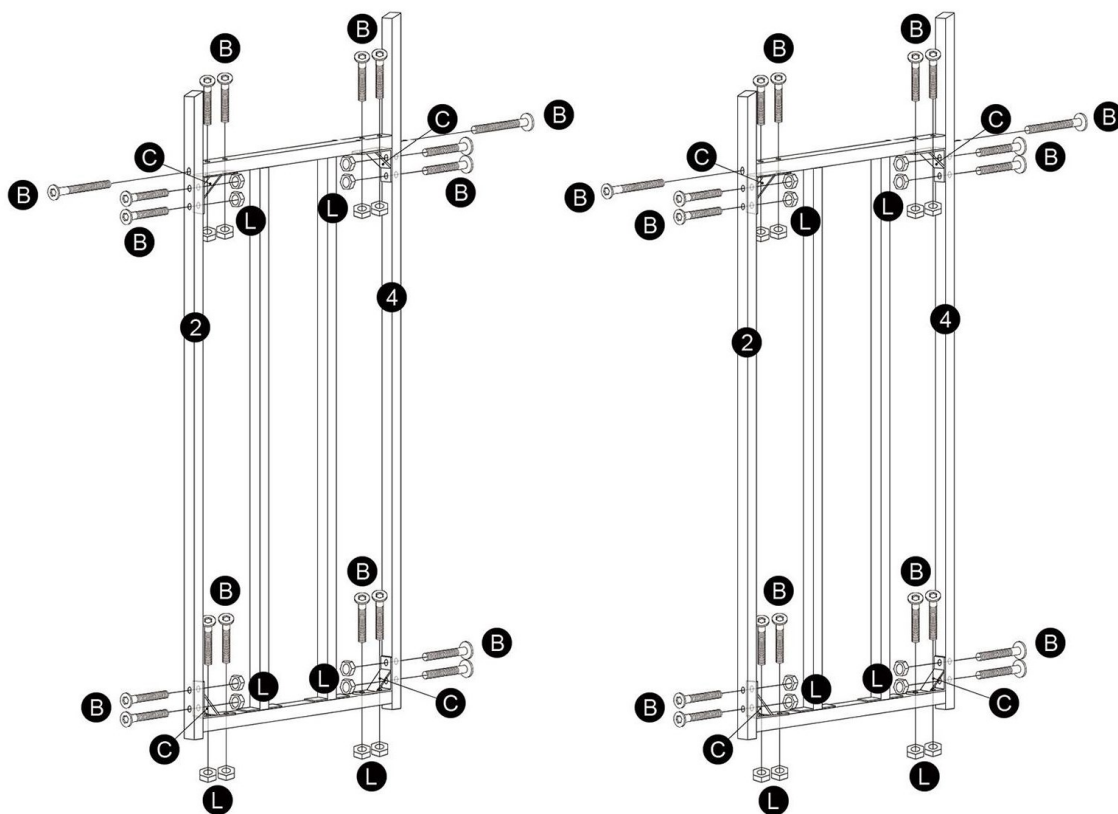

Passaggio 2

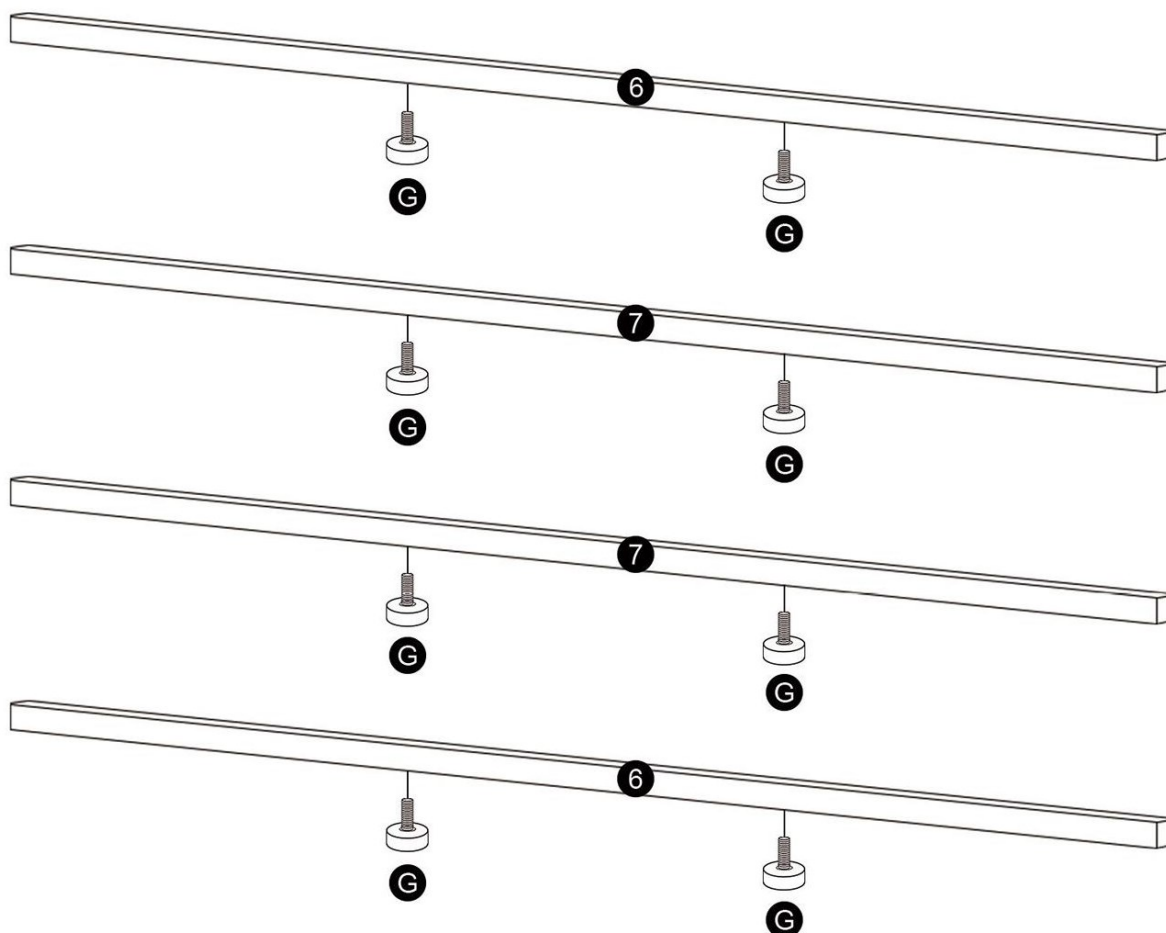

Passaggio 3

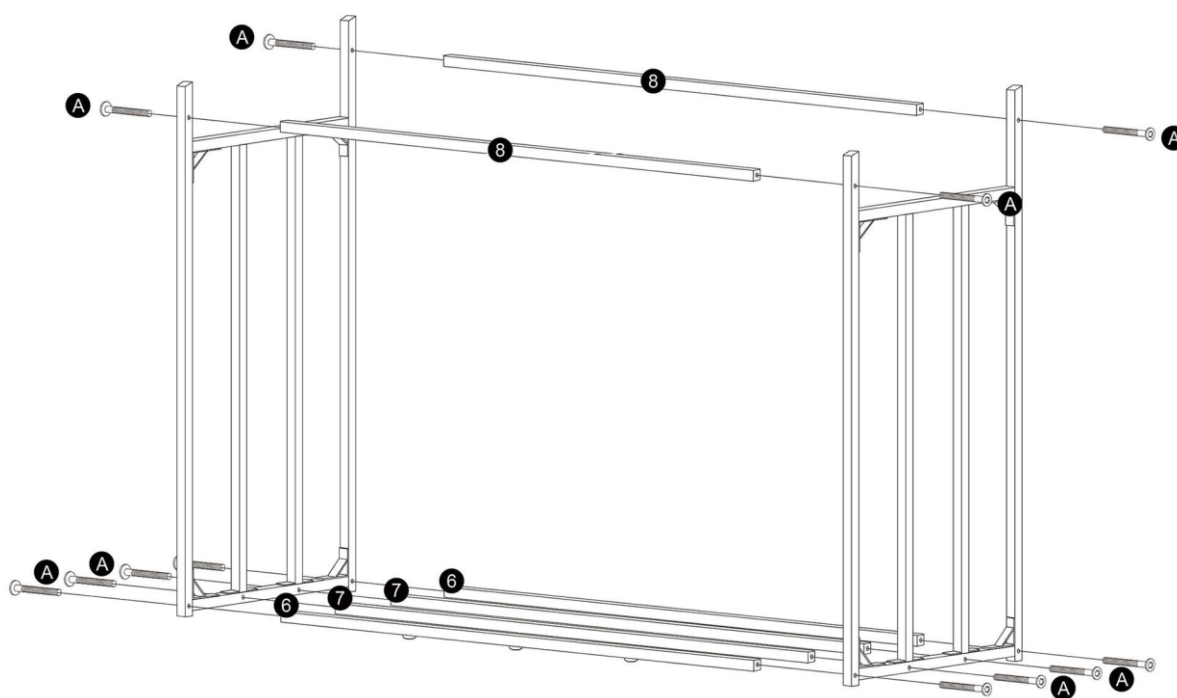

Passaggio 4

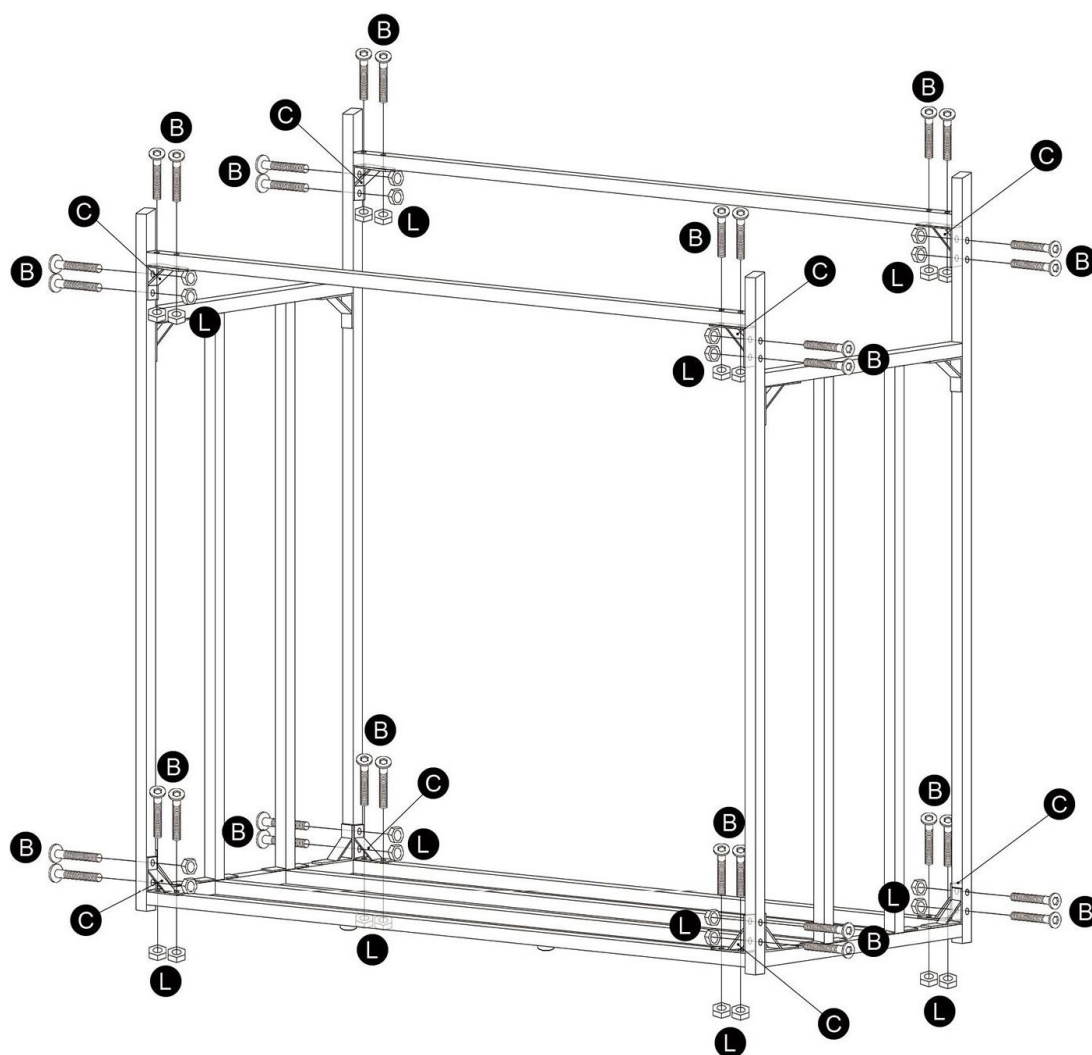

Passaggio 5

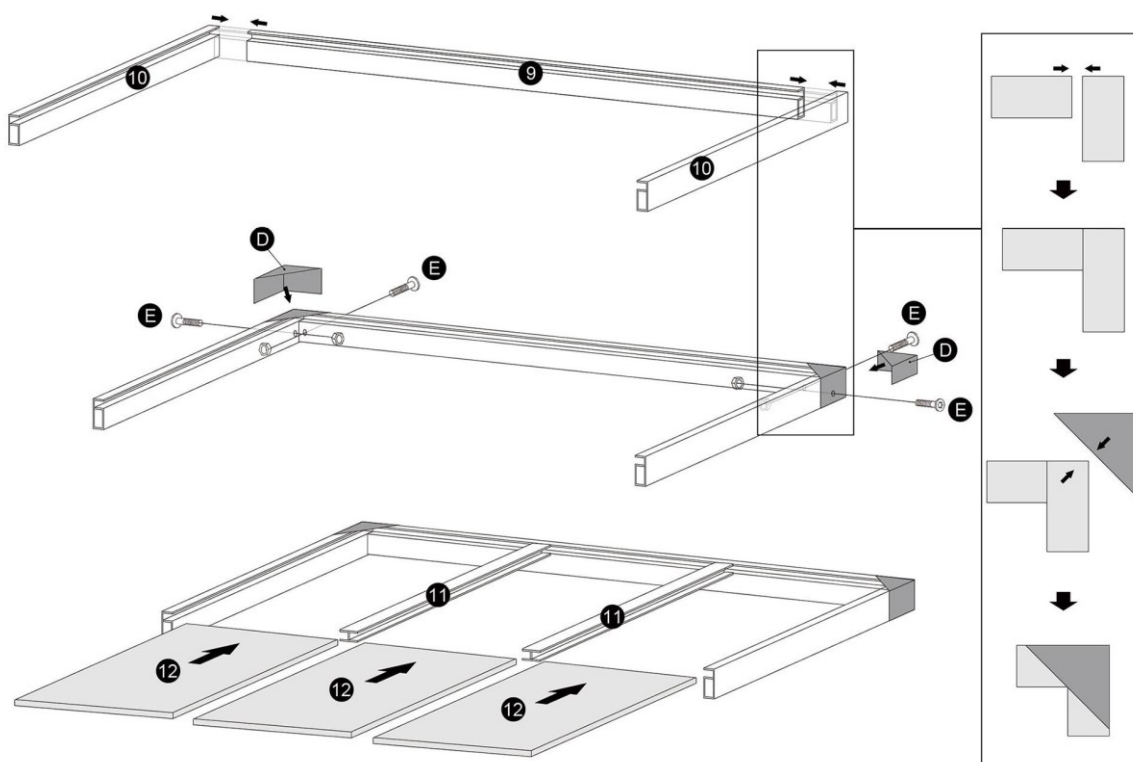

Passaggio 6

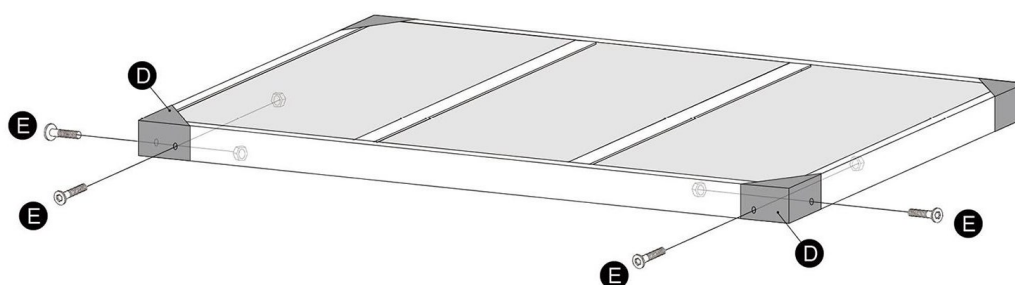
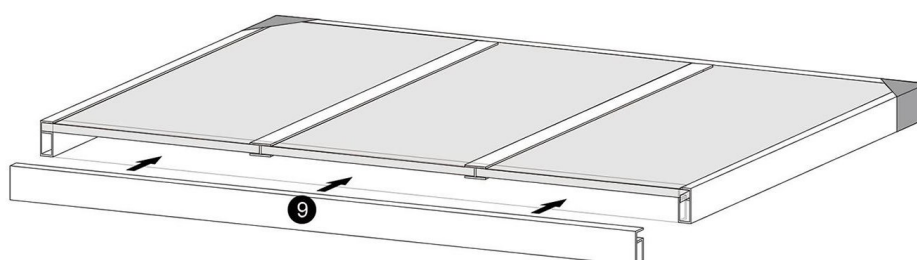

Passaggio 7

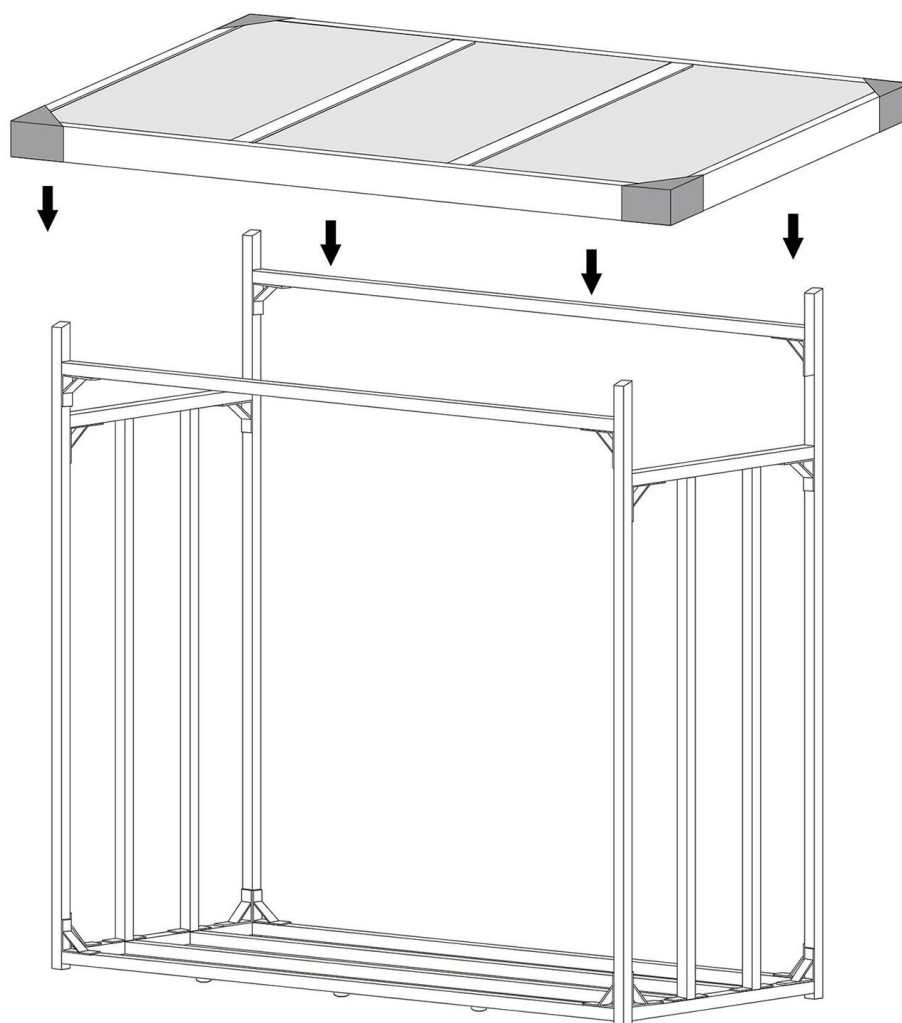

Passaggio 8

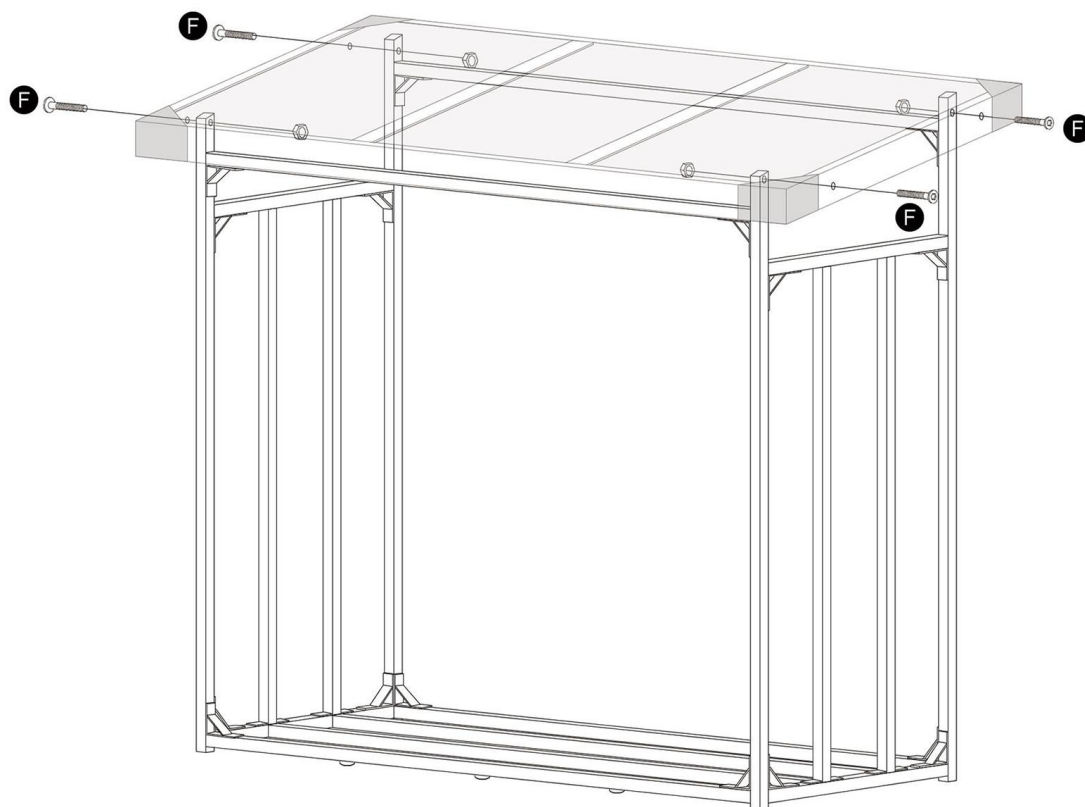

Passaggio 9

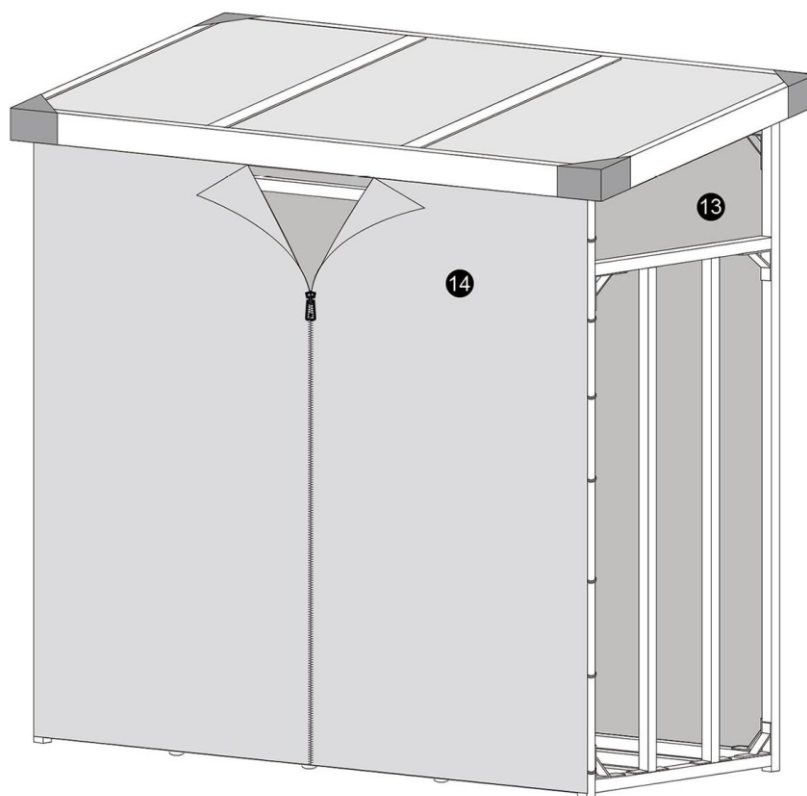

Passaggio 10

**Avvertenza importante:** La riproduzione e l'uso ai fini commerciali di una parte o di tutto il manuale sono consentiti solo previa autorizzazione scritta di WilTec Wildanger Technik GmbH.