















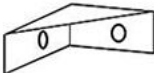
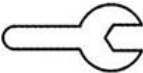







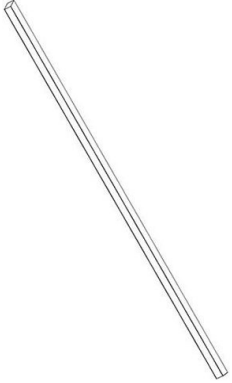

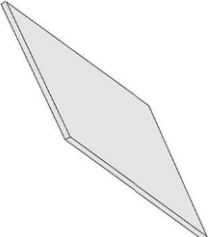

Skrudar och tillbehör							
Bokst.	Avb.	Avm. (mm)	Ant.	Bokst.	Avb.	Beteckn.	Ant.
A		M8×40	16	G		Fot	8
B		M8×35	76	H		M6-insexnyckel	1
C		Rät vinkel-kontakt	16	I		M8-insexnyckel	1
D		Hörnstycke	4	J		M6-skift-nyckel	1
E		M8×16	8	K		M8-skift-nyckel	1
F		M8×45	4	L		Mutter	72

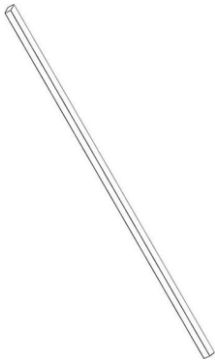
Delar								
Nr.	Avb.	Ant.	Nr.	Avb.	Ant.	Nr.	Avb.	Ant.
1		2	6		2	11		2
	650 × 25 × 25			1250 × 25 × 25			805 × 20 × 10	
2		2	7		2	12		3
	1710 × 25 × 25			1250 × 25 × 25				

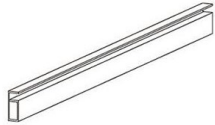

3		4	8		2	13	 Back cloth Ryggduk	1
	1410 × 25 × 25			1250 × 25 × 25				
4		2	9		2	14	 Front cloth Framduk	1
	1835 × 25 × 25			1300 × 30 × 10				
5		2	10		2			
	650 × 25 × 25			825 × 30 × 10				

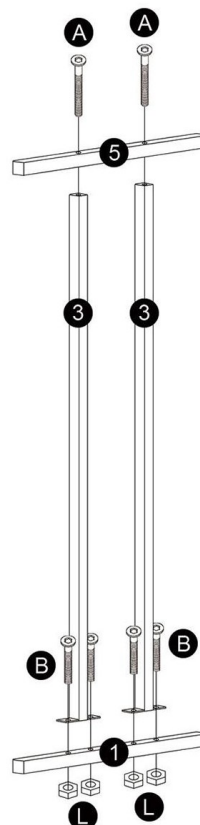
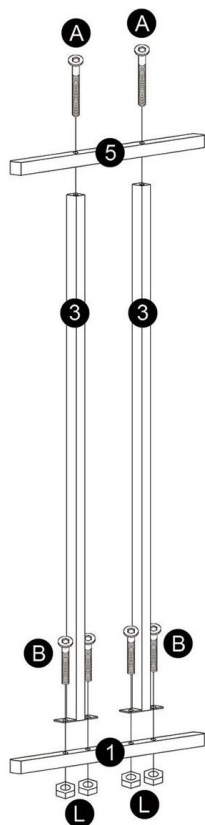

Steg 1

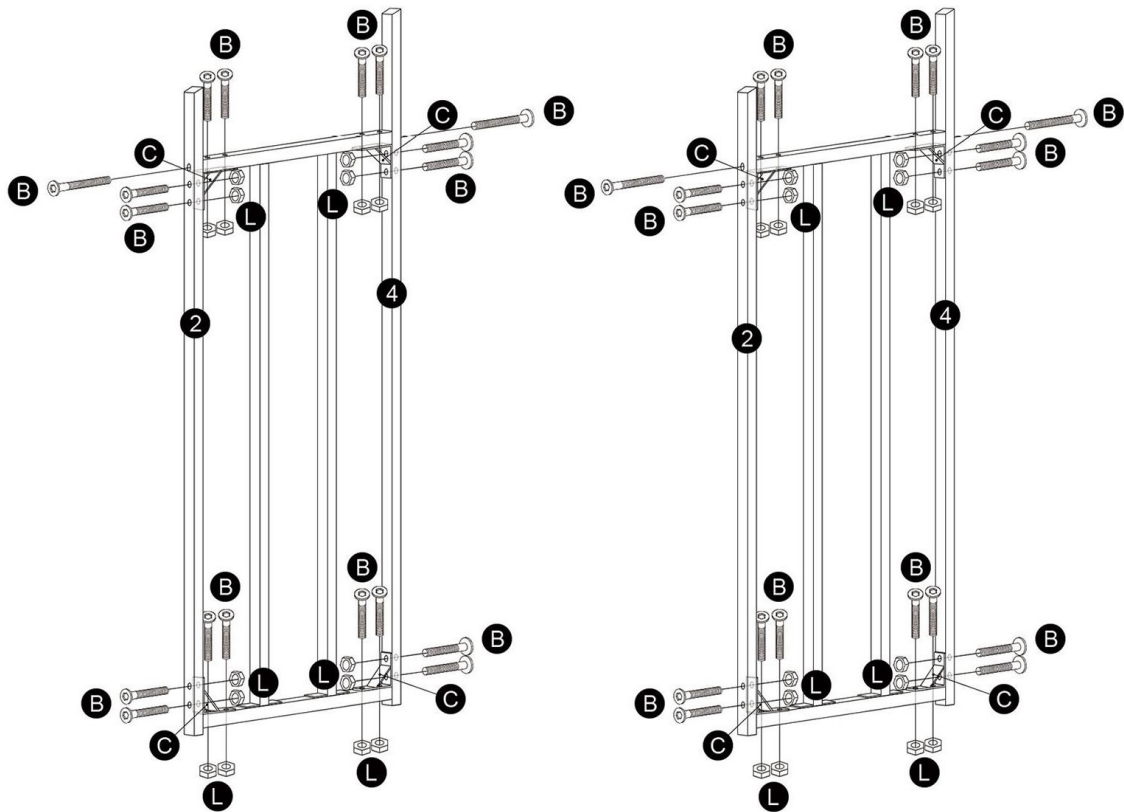

Steg 2

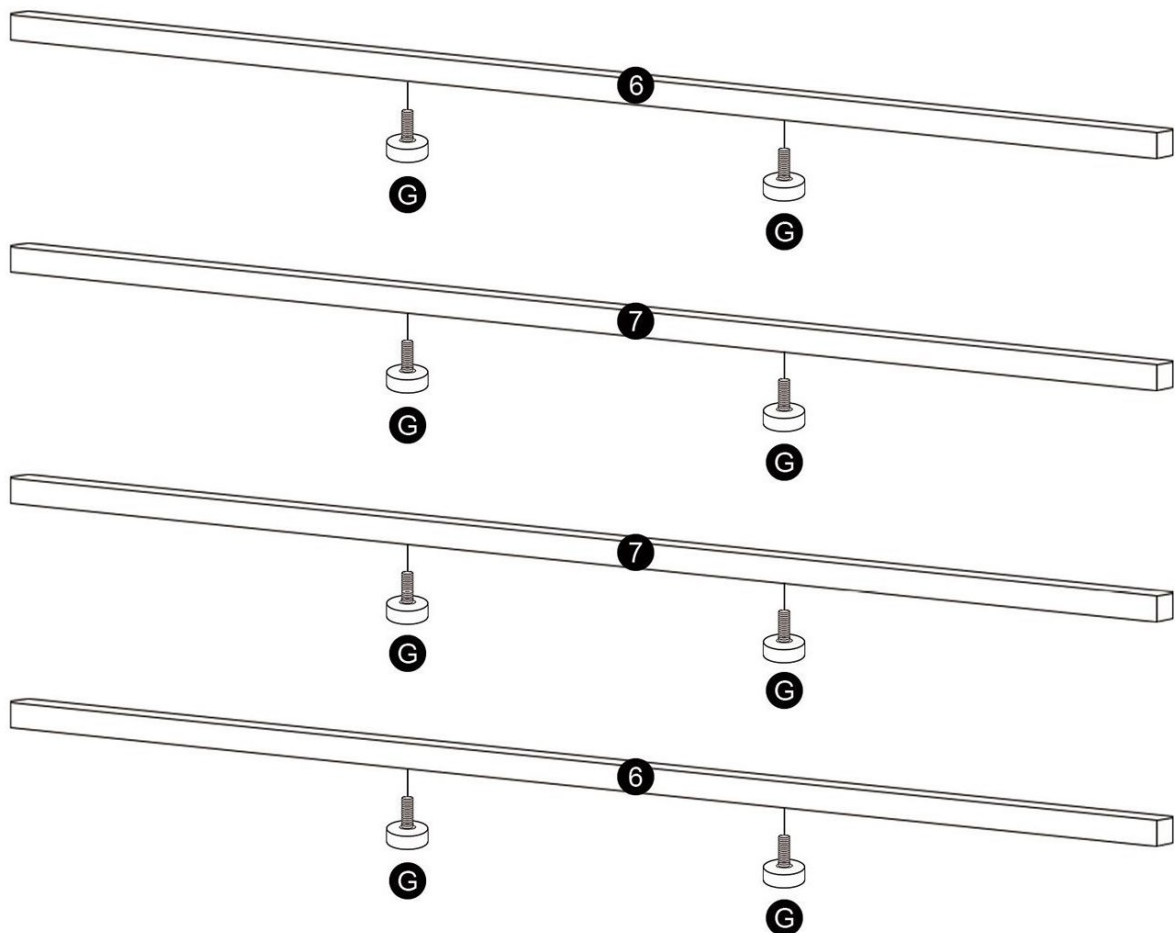

Steg 3

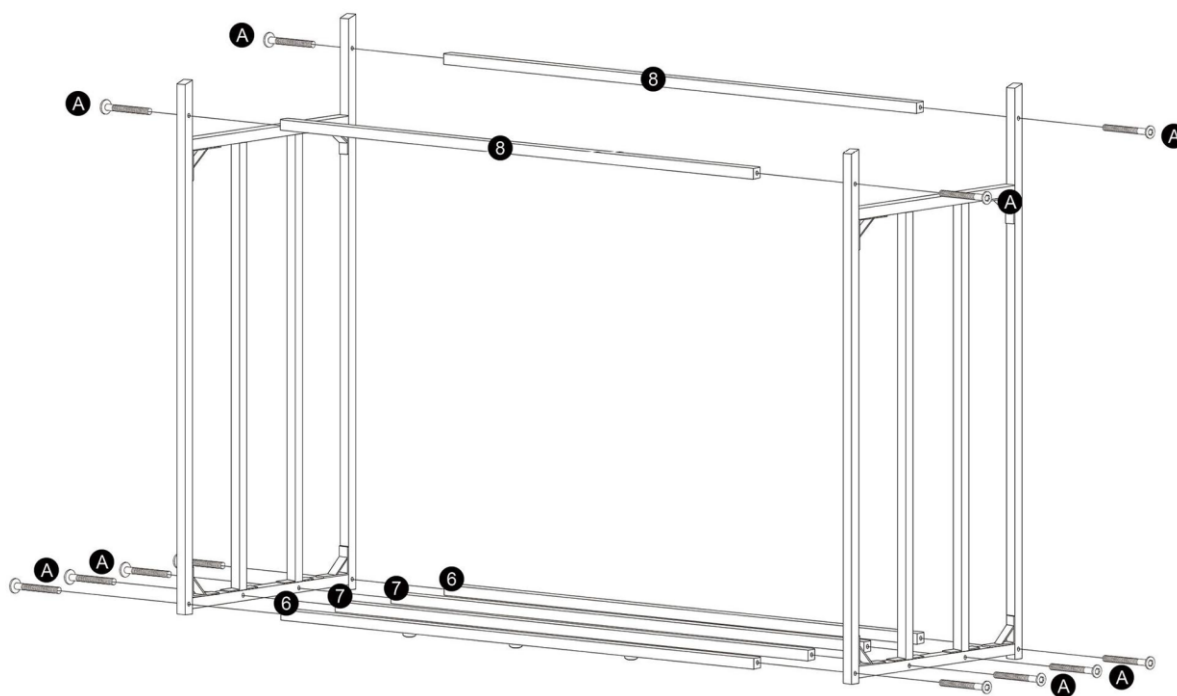

Steg 4

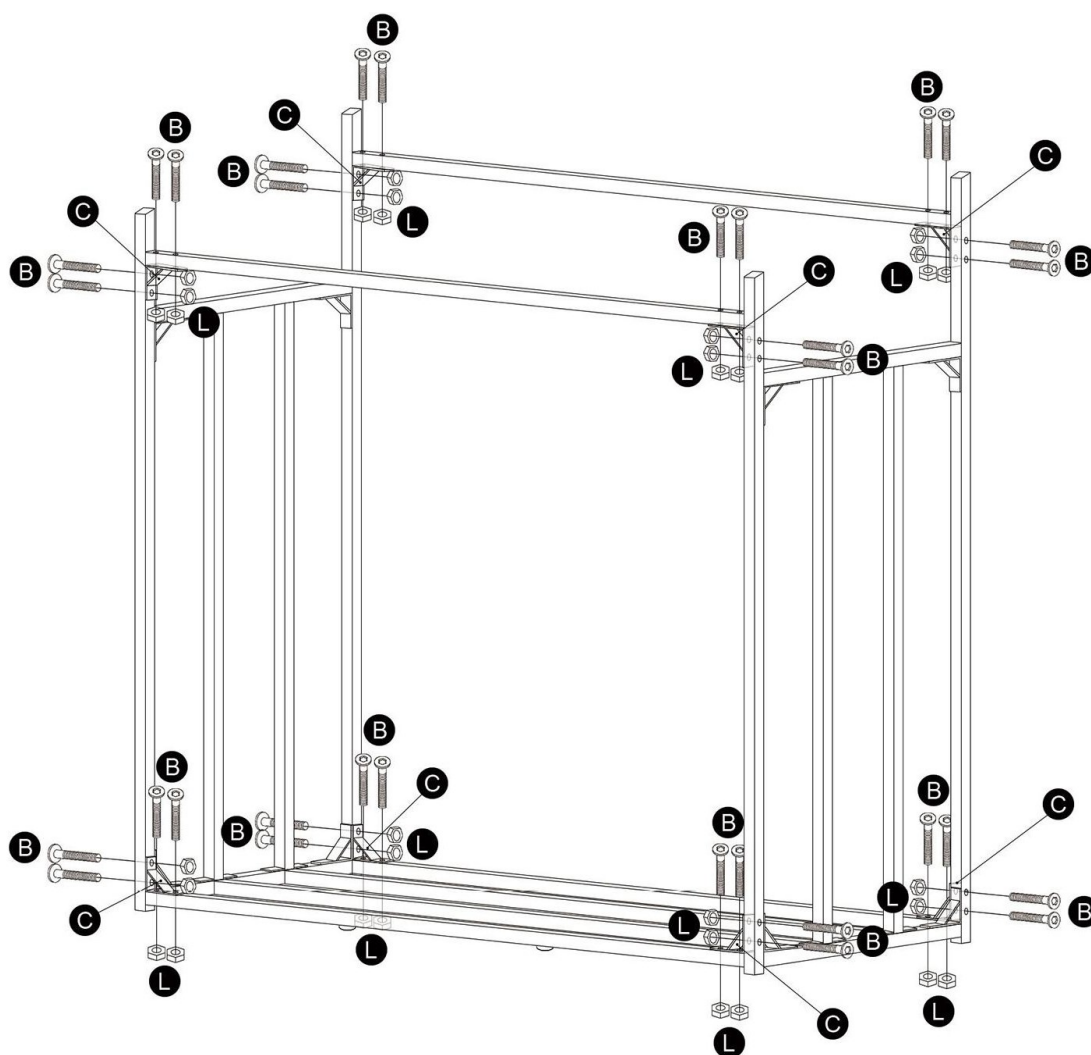

Steg 5

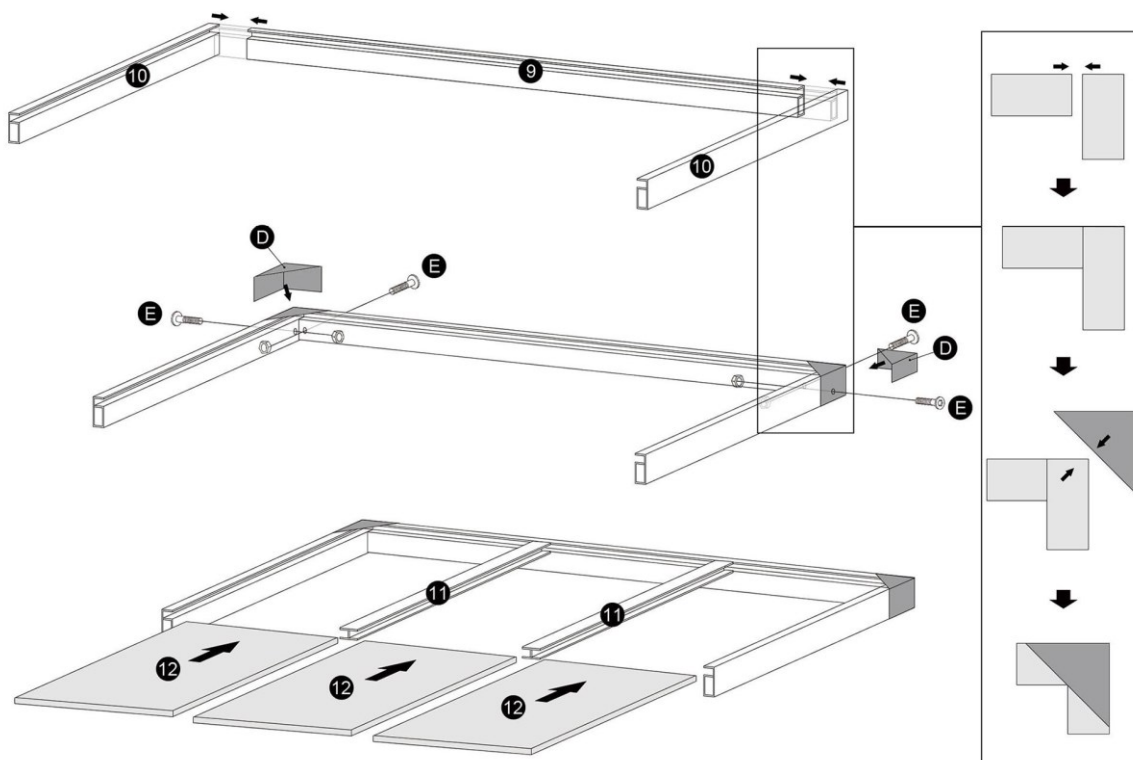

Steg 6

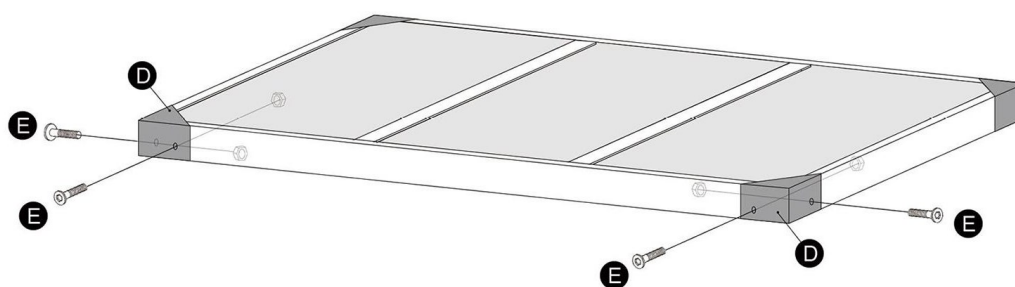
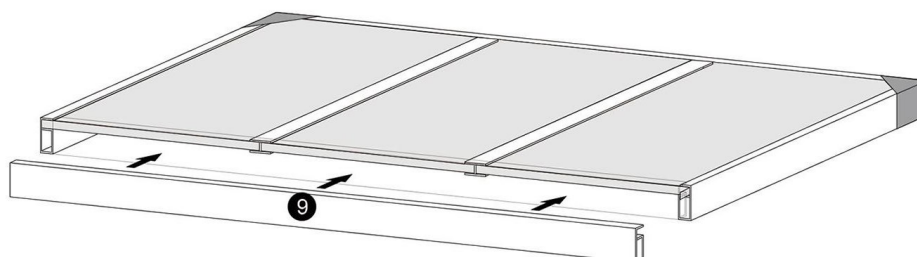

Steg 7

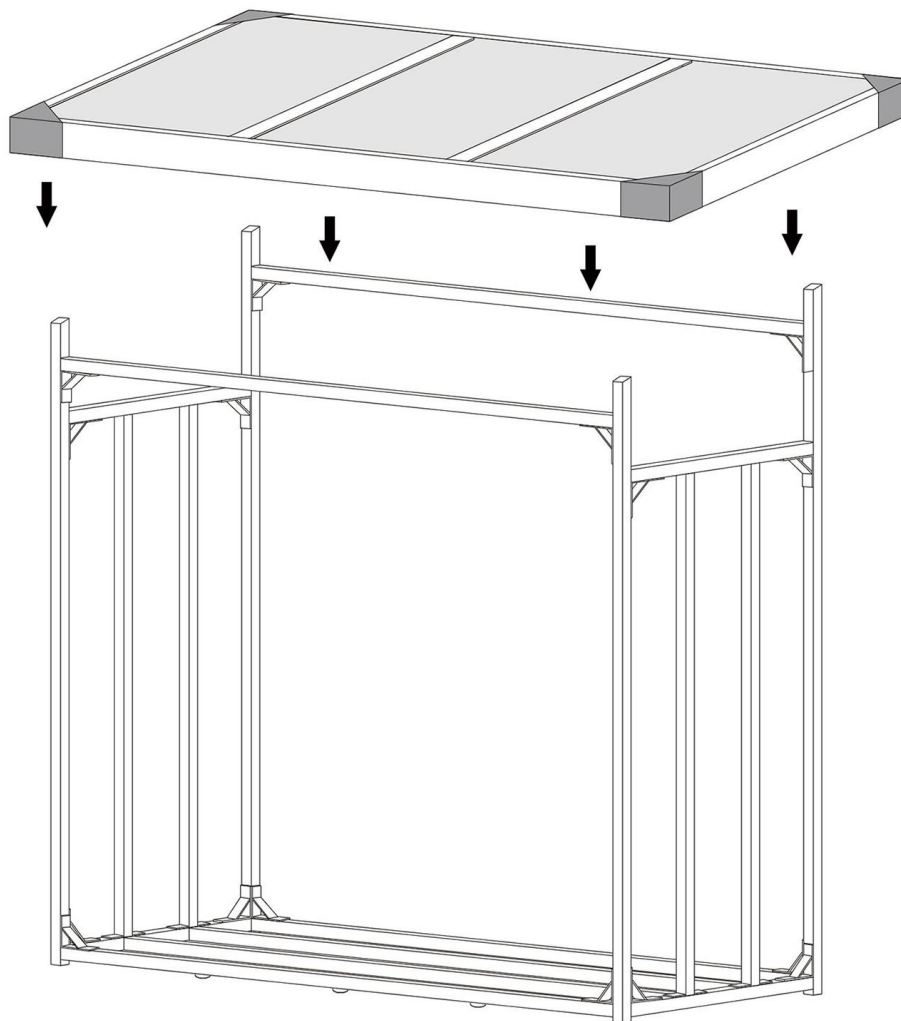

Steg 8

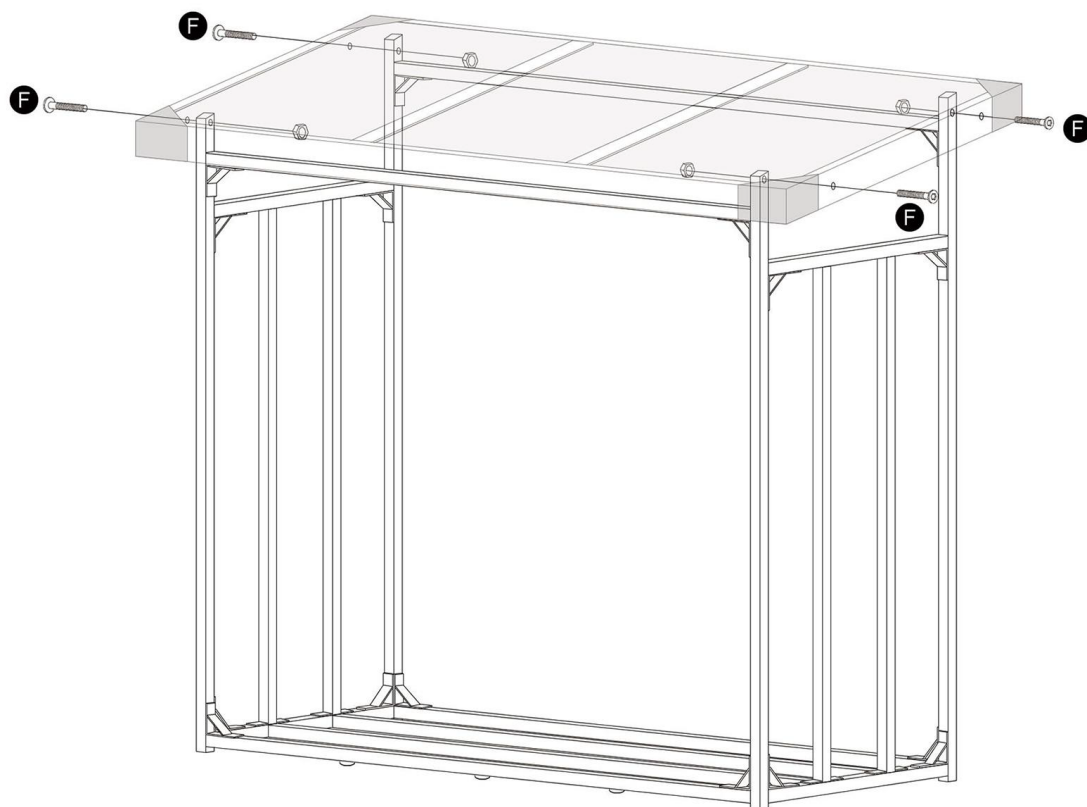

Steg 9

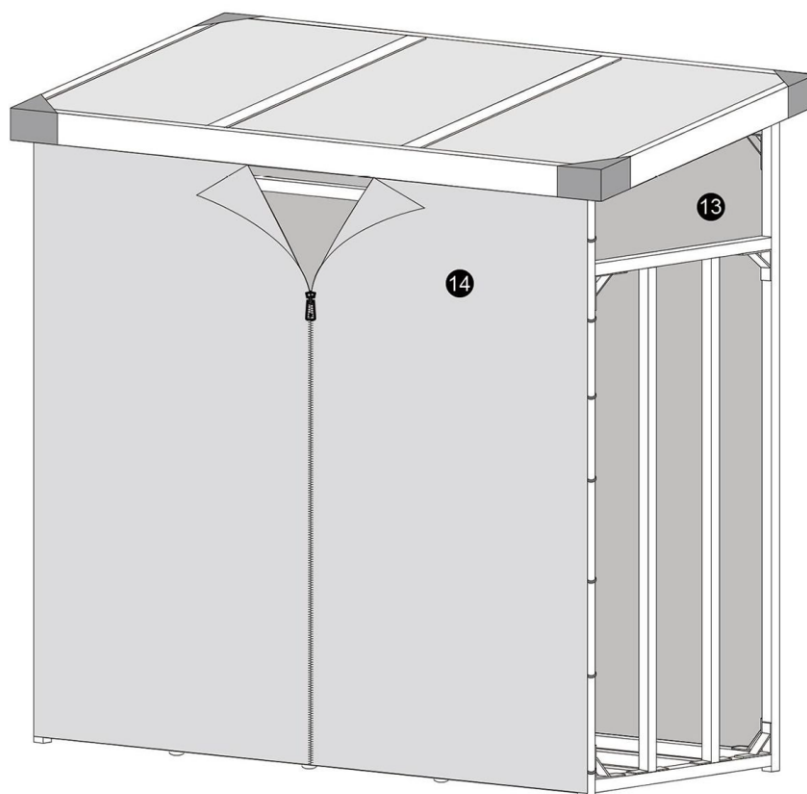

Steg 10

Viktig anmärkning: Varje sätt av delvis eller fullständigt mångfaldigande eller kommersiellt nyttjande av denna bruksanvisning behöver ett skriftligt godkännande från WilTec Wildanger Technik GmbH.