

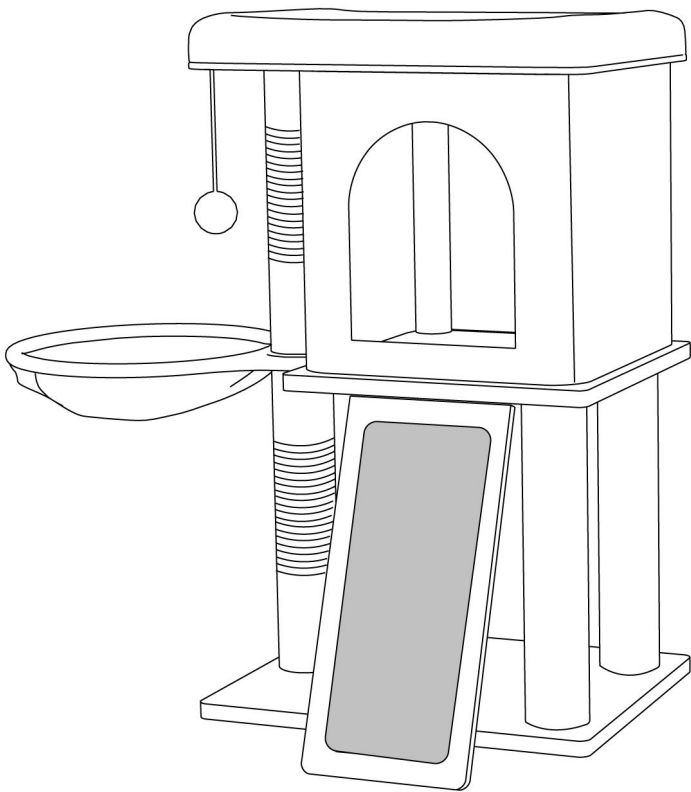









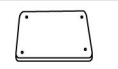

CAT TREE -Manual

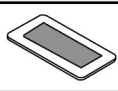
Part List

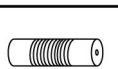

1		1pc	40*30cm	A		1pc	M8*80mm
2		1pc	30*30cm	B		14pc	M8*35mm
3		1pc	40*30cm	C		4pc	M8*16mm
4		1pc	36*16cm	D		2pc	
5		1pc	Φ30cm	E		1pc	
6		1pc	25cm				
7		1pc	35cm				
8		2pc	30cm				
9		4pc	29cm				
10		1pc					

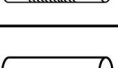
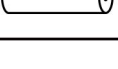
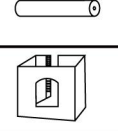
Installation Steps

STEP 1

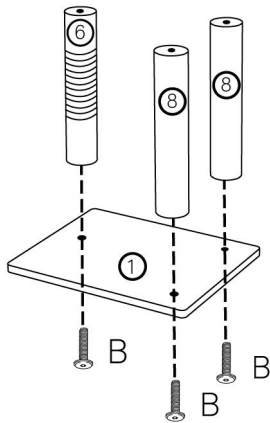

STEP 2

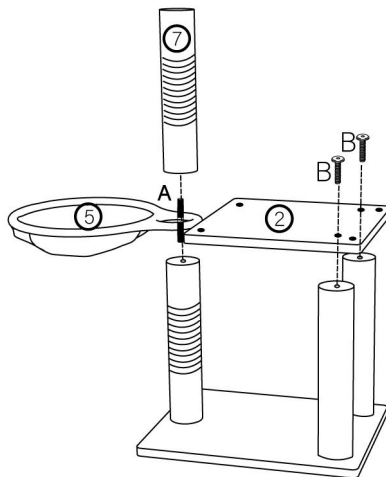

STEP 3

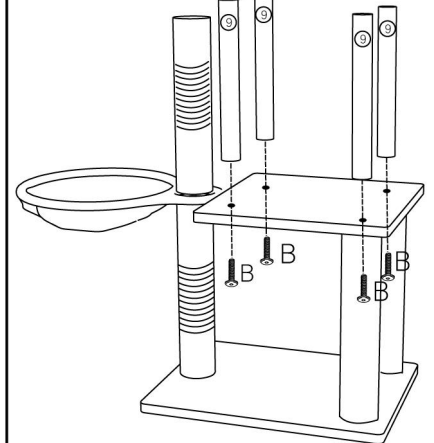

STEP 4

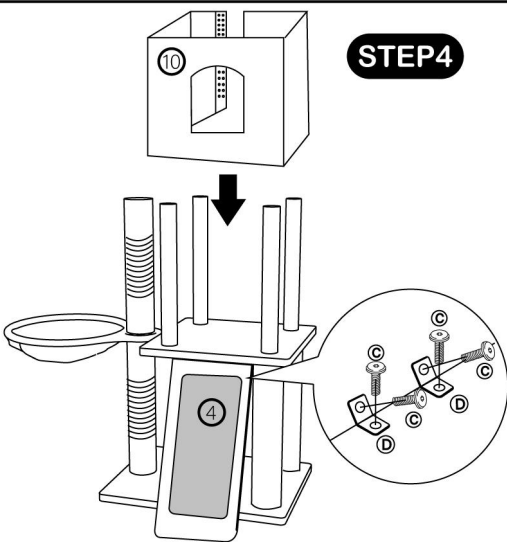

STEP 5

